

..... altre documentazioni



Listino PREZZI



Catalogo KABLO



Catalogo GRIGLIA e
Canali in Metallo



Catalogo KLIMA



Catalogo OFFICE-PLUS



Catalogo WALKABLE



Catalogo Protection

Via G. Di Vittorio, 34/36
50067 - Rignano sull'Arno (Fi)
Telefono +39 055 8349181
Telefax +39 055 8349185
Sito: www.arnocanali.it
E-mail: info@arnocanali.it



La nostra esperienza al servizio del cliente

Arnocanali è una realtà giovane e dinamica, è stata fondata nel 1979 ed ha più di 40 anni di esperienza nella progettazione e costruzione di componenti per la connessione in bassa tensione e di materiale da installazione, sia nel settore civile che in quello industriale. Ha assunto negli anni una posizione di assoluto rilievo sia nel mercato Italiano che in quello Europeo. La continua ricerca di nuovi prodotti, volta a risolvere le problematiche dei professionisti, rende Arnocanali una azienda di riferimento.

Il controllo globale dei processi, dalla scelta delle materie prime al controllo della produzione, garantisce al prodotto finito ottima qualità ed affidabilità. Gli investimenti in nuove tecnologie permettono ad Arnocanali di consegnare gli ordini in tempi ridotti, coscienti del fatto che i nostri servizi devono essere di ottima qualità poiché servono a dare supporto al Business quotidiano dei nostri clienti. Il "Tecnico Amico" fornisce informazioni tecniche per l'installazione dei prodotti ed informazioni sulle normative, mentre il Commerciale Amico fornisce informazioni sulla reperibilità dei prodotti presso i rivenditori ed organizza consegne veloci. La nostra politica aziendale è da sempre icona di Qualità, Servizio, Innovazione e totale soddisfazione verso il cliente.

Our experience at customer service

Arnocanali is a very young and dynamical company, it was founded in 1979 and it has more than 40 years of experience in the planning and production of components for the low tension connection and of the installation material, both in the civil and industrial field. During the years Arnocanali has reached a leading position in the italian market as well as in the European one. The continuous research for new articles, set forth with the aim to solve the problems of the professionals renders Arnocanali a reference company. The global control of every process, the choice of the raw materials, and the control of the production process grants to the end product excellent quality and reliability. The investments in new technologies allow Arnocanali to deliver the orders in a very little time, aware of the fact that excellent services must be provided, what will help the daily business of the clients. The service "Tecnico Amico" provides technical information about installation, while the service "Commerciale Amico" provides information about where to find products; this number can also be called for any necessity of fast deliveries. The politics of Arnocanali has always been and will always be synonym of Quality, Service, Innovation and total collaboration towards its clients.





Sistemi di canalizzazione in pvc e ALLUMINIO
Trunkings systems of pvc and ALUMINIUM

pagina 6



Torrette a scomparsa filo pavimento,
torrette e colonne in ALLUMINIO, moduli elettrificabili
Flush floor outlet socket boxes,
turrets and office-poles of ALUMINIUM, wiring modules

pagina 94



Sistemi di canali e accessori per il cablaggio
di quadri elettrici
Wiring trunking systems and accessories
for electrical panels

pagina 192



Canali passacavi carrabili
Cable ramps system

pagina 192



Morsetti per cablaggi civili
Terminals for civil wiring

pagina 224



Morsettiere per cablaggi industriali
Terminal blocks for industrial wiring

pagina 224



Sonde passacavi e accessori
Fish tapes and accessories

pagina 272



Lubrificanti per cavi, traccianti,
gel e gomme isolanti e sigillanti
Cable lubricants, wall tracer,
insulating and sealing gels and rubbers

pagina 272



Pressacavi, fascette, fissatubi
e accessori per tubi IP40 e IP67
Cable glands, cable ties, pipe clamps
and pipes accessories IP40 and IP67

pagina 272



Pozzetti elettrici e per irrigazione,
accessori e pali in fibra di vetro
Electric and irrigation well boxes,
accessories and fiberglass poles

pagina 272



Scaricatori di sovratensione
Surge arresters

pagina 352



Componenti per impianti parafulmine
e di messa a terra
Components for lightning protection
and earthing systems

pagina 352



Laboratorio certificato e riconosciuto IMQ

IMQ è membro dei principali accordi per il rilascio di marchi europei e internazionali. A livello nazionale e internazionale gode di numerosi riconoscimenti dovuti alla partecipazione di esperti ai lavori normativi di comitati tecnici e scientifici, a riunioni per gli accordi internazionali di certificazione, a riunioni promosse da Associazioni di costruttori e installatori e alle commissioni operanti presso i Ministeri. La Mission di IMQ e Arnocanali è quella di tutelare il produttore e il consumatore fornendo qualità dei prodotti immessi sul mercato interno. Tutti i prodotti Arnocanali sono costruiti in conformità alle più recenti normative internazionali del settore elettrico in bassa tensione. Per questo abbiamo ottenuto le approvazioni da parte dei più prestigiosi istituti di certificazione nazionali ed internazionali.



Arnocanali parte del comitato CEI

Il CEI è un'Associazione riconosciuta dallo Stato Italiano e dall'Unione Europea per le attività normative e di divulgazione della cultura tecnico-scientifica. Le norme tecniche europee pubblicate dal CEI costituiscono uno strumento univoco e ben codificato per soddisfare le prescrizioni di natura obbligatoria previste dalla legislazione italiana. Il processo di normazione si basa sul principio della partecipazione e della collaborazione di tutte le parti coinvolte, di cui Arnocanali fa parte. La mission del CEI, quale organo super partes, è quella di elaborare documenti normativi di buona tecnica, partecipare alla stesura e recepire documenti normativi armonizzati europei, partecipare alla stesura di normative internazionali, diffondendo cultura tecnica e della sicurezza elettrica a tutti i consumatori.

Certified laboratory recognized IMQ

IMQ takes part in the main agreements for the grant of European and international marks. It enjoys several acknowledgements both on a national and international level, thanks to the participation of experts to all normative works of the technical and scientific committees, meetings for the international certification agreements, meetings promoted by builder and installer associations, as well as committees working in the various ministries. The aim of IMQ and Arnocanali is to protect both the producer and the customer, providing products of quality on the international market. All Arnocanali products are built in conformity with the most recent international norms of the low tension electrical field. For these reasons Arnocanali has deserved the approval of the most important national and international certifying institutions.



Arnocanali is part of committee CEI

CEI is an association recognized by both Italy and the European Union for the normative acts and the spreading of technical and scientific culture. All European technical norms published by CEI are a univocal and well codified instrument to meet the requirements of the Italian law. The standardization process is based on the principle of participation and collaboration of all parties involved, Arnocanali included. The mission of CEI, as impartial organization, is to work out normative standards technically good, to take part in the drafting and gather European normative documents, to take part in the drafting of international standards spreading the culture of technology and electrical safety. Furthermore, it is CEI's duty to make sure that all materials, products and facilities be always in accordance with the rule book.

Sito internet
www.arnocanali.it

Sul sito internet di Arnocanali sarete aggiornati in tempo reale sulle novità già presenti o quelle in uscita. Il nostro sito è uno strumento di lavoro per tutti i professionisti. Al suo interno, potrete scaricare tutte le documentazioni operative tra cui il catalogo generale ed il listino figurato. Inoltre potrete accedere alle certificazioni IMQ, certificazioni R.I.N.A., certificazioni SEMKO, alle certificazioni aziendali, alle schede di sicurezza, alle voci di capitolato ed alle schede tecniche.

Web site
www.arnocanali.it

On the website of Arnocanali will be updated in real time on news already present or outgoing. Our site is a working tool for all professionals. Inside, you can download all the operational documents including the general catalog and figurative price list. You can also access the IMQ certifications, R.I.N.A. certifications, SEMKO approvals, corporate approvals, the safety data sheets, the specification items and the technical data sheets.





Minikappa

8

Sistemi di minicanali
Mini-trunking systems



Minikappa *Tape*

22

Sistemi di minicanali con adesivo
Mini-trunking systems with adhesive tape



Kappa

26

Sistemi di canali di distribuzione
Distribution trunking systems



Space

42

Sistemi di canali distribuzione
Parapet trunking systems



Aluspace

50

Sistemi di canali di distribuzione
in ALLUMINIO
Parapet trunking systems
of ALUMINIUM



Wing *Design*

58

Sistemi di canali a battiscopa e cornice
Skirting and wall trunkings systems



Double

72

Sistema di canali a cornice
Wall trunking system



Corner

78

Sistema di canali angolari
Corner pvc trunking system



Camber

84

Sistema di canali sopra pavimento
Overfloor trunking system



Tora

90

Torrette bifacciali in plastica
Bifacial plastic turrets

MINIKAPPA

Sistema di minicanali
con coperchio standard o avvolgente,
per applicazioni a parete e soffitto

Minitrunking system
with standard or wrapping cover,
for wall and ceiling applications





Caratteristiche Tecniche

- Canale in PVC ed accessori in ABS
- Canale lunghezza standard 2 metri
- Apertura coperchio con attrezzo
- Resistenza all'urto IK 07 (2J)
- Grado di protezione IP40
- Tensione nominale 750V
- Temperatura di utilizzo -15°C +60°C

Technical Features

- PVC Trunkings and ABS accessories
- Trunking standard length 2 meters
- Cover disassembling with tool
- Mechanical protection IK 07 (2J)
- Protection degree IP40
- Rated voltage 750V
- Working temperature -15°C +60°C

Riferimenti a Norme

- Conforme alla norma CEI EN 50085-2-1
- Conforme alla Direttiva RoHS 2015/863/EU
- Conforme alla Direttiva B.T. 2009/95/CE

Norms Reference

- Complies with standard CEI EN 50085-2-1
- Compliant with RoHS Directive 2015/863/EU
- Compliant with the Low Voltage Directive 2009/95/EC

Marchi e Certificazioni

- Marchio IMQ riferimento n° EP004 (K)
- Marchio IMQ riferimento n° EE893 (KDU)
- Marcatura CE

Marks and Certifications

- IMQ mark reference n° EP004 (K)
- IMQ mark reference n° EE893 (KDU)
- CE marking

Colori disponibili

- Bianco RAL9010, Grigio RAL7030, Marrone RAL8014, Finitura faggio, Finitura ciliegio

Available colours

- White RAL9010, Grey RAL7030, Brown RAL8014, Beech finish, Cherry finish

Esempio applicativo accessori Example of accessories application

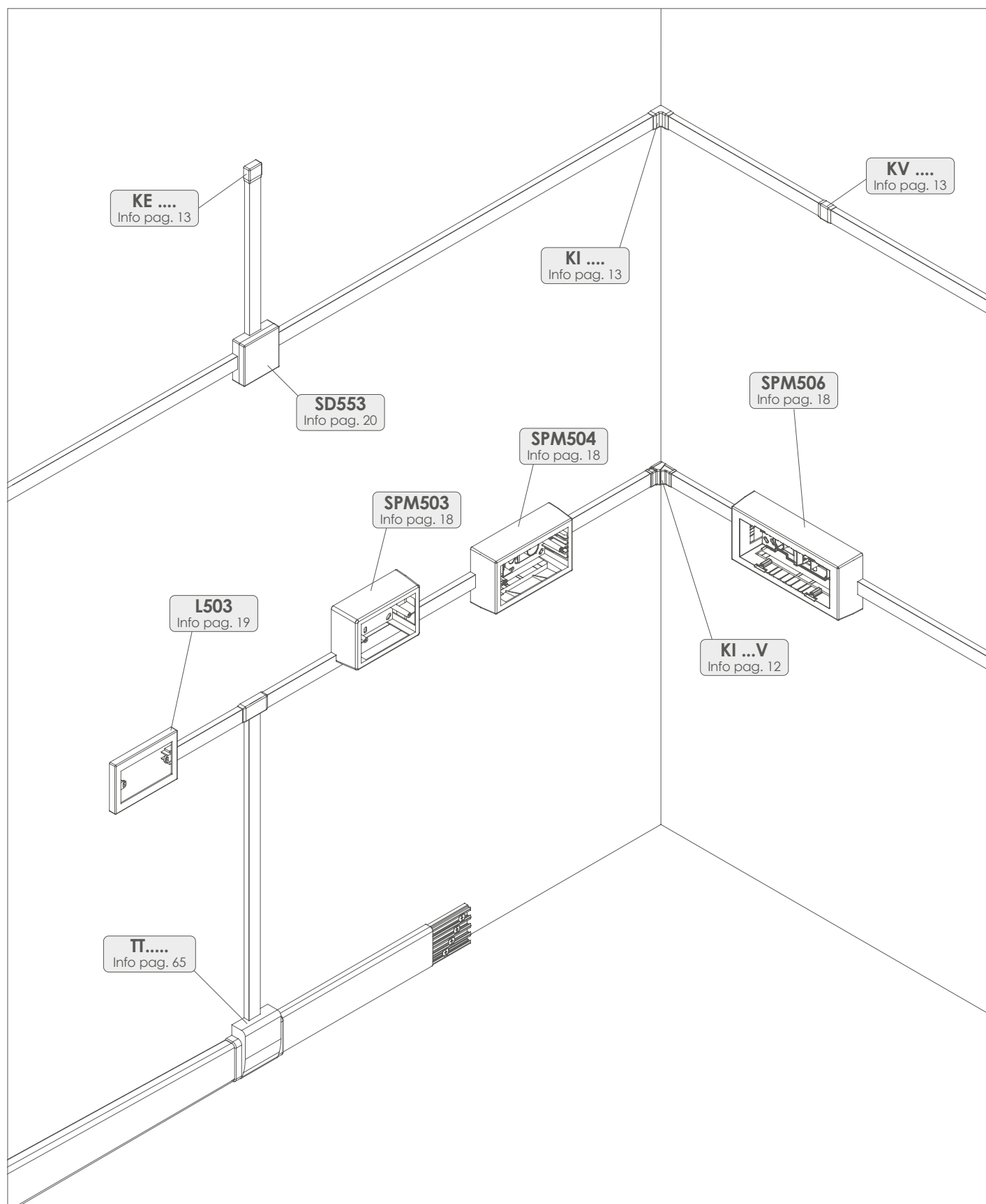





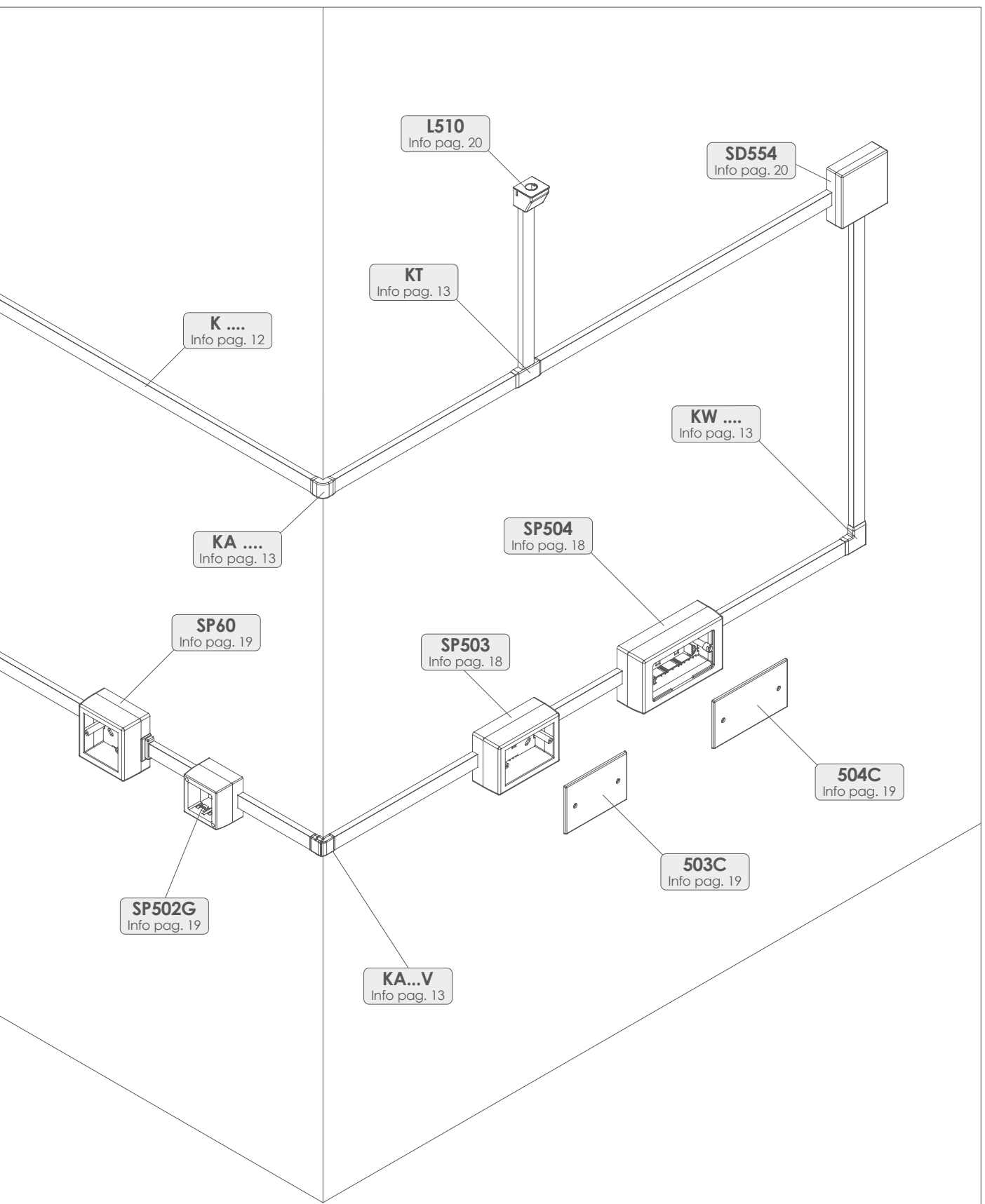













Colori disponibili: (.3) Bianco RAL9010, (.1) Grigio RAL7030, (.5) Marrone RAL8014,
(.53) Finitura faggio, (.52) Finitura ciliegio

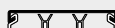





Available colours: (.3) White RAL9010, (.1) Grey RAL7030, (.5) Brown RAL8014,
(.53) Beech finish, (.52) Cherry finish



Minicanale con coperchio standard Minitrunking with standard cover















						
Profilo Profile	Dimensioni B x H Dimensions B x H	Scomparti Section	Canale e coperchio Trunking and cover	Angolo interno variabile Variable internal angle	Angolo esterno variabile Variable external angle	Angolo interno Internal angle
	10x10 mm	1	K1010.3			KI1010.3
	21x10 mm	1	K1022.1 K1022.3 K1022.5			KI1022.3 KI1022.5
	30x10 mm	2	K1031.3			KI1030.3
	15x15 mm	1	K1515.1 K1515.3 K1515.5			KI1515.3
	18x18 mm	1	K1818.3			KI1818.3
	25x18 mm	1	K1825.3			KI1825.3
	30x18 mm	1	K1830.1 K1830.3 K1830.5	KI1830V.3	KA1830V.3	KI1830.3 KI1830.5
	30x18 mm	2	K1831.3	KI1830V.3	KA1830V.3	KI1830.3 KI1830.5
	40x18 mm	2	K1841.1 K1841.3	KI1840V.3	KA1840V.3	
	50x18 mm	3	K1852.3			KI1850.3
	30x25 mm	1	K2530.1 K2530.3	KI2530V.3	KA2530V.3	KI2530.3
	40x25 mm	1	K2540.3	KI2540V.3	KA2540V.3	KI2540.3
	40x25 mm	2	K2541.3	KI2540V.3	KA2540V.3	KI2540.3
	30x30 mm	1	K3030.3	KI3030V.3	KA3030V.3	KI3030.3
	40x40 mm	1	K4040.1 K4040.3 K4040.5	KI4040V.3	KA4040V.3	KI4040.3

Colori disponibili: (.3) Bianco RAL9010, (.1) Grigio RAL7030, (.5) Marrone RAL8014
Available colours: (.3) White RAL9010, (.1) Grey RAL7030, (.5) Brown RAL8014

					
Angolo esterno External angle	Curva piana Flat angle	Deviazione a T T-Joint	Coprigiunzione Cover joint	Terminale End piece	Traversa reggicavo Cable clamp
KA1010.3	KW1010.3	KT1010.3	KV1010.3	KE1010.3	
KA1022.3 KA1022.5	KW1022.3 KW1022.5	KT1022.3 KT1022.5	KV1022.3 KV1022.5	KE1022.3 KE1022.5	
KA1030.3	KW1030.3	KT1030.3	KV1030.3	KE1030.3	
KA1515.3	KW1515.3	KT1515.3	KV1515.3	KE1515.3	
KA1818.3	KW1818.3	KT1818.3	KV1818.3	KE1818.3	
KA1825.3	KW1825.3	KT1825.3	KV1825.3	KE1825.3	
KA1830.3 KA1830.5	KW1830.3 KW1830.5	KT1830.3 KT1830.5	KV1830.3 KV1830.5	KE1830.3 KE1830.5	KTR30
KA1830.3 KA1830.5	KW1830.3 KW1830.5	KT1830.3 KT1830.5	KV1830.3 KV1830.5	KE1830.3 KE1830.5	KTR30
	KW1840.3	KT1840.3	KV1840.3	KE1840.3	
KA1850.3	KW1850.3	KT1850.3	KV1850.3	KE1850.3	
KA2530.3	KW2530.3	KT2530.3	KV2530.3	KE2530.3	KTR30
KA2540.3	KW2540.3	KT2540.3	KV2540.3	KE2540.3	KTR40
KA2540.3	KW2540.3	KT2540.3	KV2540.3	KE2540.3	KTR40
KA3030.3	KW3030.3	KT3030.3	KV3030.3	KE3030.3	KTR30
KA4040.3	KW4040.3	KT4040.3	KV4040.3	KE4040.3	





Minicanale con coperchio standard, sottoconfezione in blister
Minitrunking with standard cover, sub-pack in blister

Blister



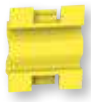

						
Profilo Profile	Dimensioni B x H Dimensions B x H	Scomparti Section	Canale e coperchio Trunking and cover	Angolo interno variabile Variable internal angle	Angolo esterno variabile Variable external angle	Angolo interno Internal angle
	21x10 mm	1	K1022BL.3			KI1022.3
	15x15 mm	1	K1515BL.3			KI1515.3
	18x18 mm	1	K1818BL.3			KI1818.3
	25x18 mm	1	K1825BL.3			KI1825.3
	30x18 mm	1	K1830BL.3	KI1830V.3	KA1830V.3	KI1830.3
	30x18 mm	2	K1831BL.3	KI1830V.3	KA1830V.3	KI1830.3
	40x18 mm	2	K1841BL.3	KI1840V.3	KA1840V.3	
	30x25 mm	1	K2530BL.3	KI2530V.3	KA2530V.3	KI2530.3
	40x25 mm	1	K2540BL.3	KI2540V.3	KA2540V.3	KI2540.3
	40x25 mm	2	K2541BL.3	KI2540V.3	KA2540V.3	KI2540.3
	40x40 mm	1	K4040BL.3	KI4040V.3	KA4040V.3	KI4040.3

Colori disponibili: (.3) Bianco RAL9010

Available colours: (.3) White RAL9010

					
Angolo esterno External angle	Curva piana Flat angle	Deviazione a T T-Joint	Coprigiunzione Cover joint	Terminale End piece	Traversa reggicavo Cable clamp
KA1022.3	KW1022.3	KT1022.3	KV1022.3	KE1022.3	
KA1515.3	KW1515.3	KT1515.3	KV1515.3	KE1515.3	
KA1818.3	KW1818.3	KT1818.3	KV1818.3	KE1818.3	
KA1825.3	KW1825.3	KT1825.3	KV1825.3	KE1825.3	
KA1830.3	KW1830.3	KT1830.3	KV1830.3	KE1830.3	KTR30
KA1830.3	KW1830.3	KT1830.3	KV1830.3	KE1830.3	KTR30
	KW1840.3	KT1840.3	KV1840.3	KE1840.3	KTR40
KA2530.3	KW2530.3	KT2530.3	KV2530.3	KE2530.3	KTR30
KA2540.3	KW2540.3	KT2540.3	KV2540.3	KE2540.3	KTR40
KA2540.3	KW2540.3	KT2540.3	KV2540.3	KE2540.3	KTR40
KA4040.3	KW4040.3	KT4040.3	KV4040.3	KE4040.3	

Minicanale con coperchio avvolgente
Minitrunking with wrapping cover

						
Profilo Profile	Dimensioni B x H Dimensions B x H	Scomparti Section	Canale e coperchio Trunking and cover	Angolo interno variabile Variable internal angle	Angolo esterno variabile Variable external angle	Angolo interno Internal angle
	21x10 mm	1	KDU1022.3			KI1022.3
	30x10 mm	2	KDU1030.3			KI1030.3
	18x18 mm	1	KDU1818.3			KI1818.3
	30x18 mm	1	KDU1830.3	KI1830V.3	KA1830V.3	KI1830.3
	30x18 mm	2	KDU1831.3	KI1830V.3	KA1830V.3	KI1830.3
	50x18 mm	2	KDU1851.3			KI1850.3

Minicanale decorato con coperchio standard
Decorated minitrunking with standard cover

Design

						
Profilo Profile	Dimensioni B x H Dimensions B x H	Scomparti Section	Canale e coperchio Trunking and cover	Angolo interno Internal angle	Angolo esterno External angle	Curva piana Flat angle
	21x10 mm	1	K1022.52 K1022.53	KI1022.52 KI1022.53	KA1022.52 KA1022.53	KW1022.52 KW1022.53
	30x18 mm	2	K1831.52 K1831.53	KI1830.52 KI1830.53	KA1830.52 KA1830.53	KW1830.52 KW1830.53

Colori disponibili: (.3) Bianco RAL9010

Available colours: (.3) White RAL9010

				
Angolo esterno External angle	Curva piana Flat angle	Deviazione a T T-Joint	Coprigiunzione Cover joint	Terminale End piece
KA1022.3	KW1022.3	KT1022.3	KV1022.3	KE1022.3
KA1030.3	KW1030.3	KT1030.3	KV1030.3	KE1030.3
KA1818.3	KW1818.3	KT1818.3	KV1818.3	KE1818.3
KA1830.3	KW1830.3	KT1830.3	KV1830.3	KE1830.3
KA1830.3	KW1830.3	KT1830.3	KV1830.3	KE1830.3
KA1850.3	KW1850.3	KT1850.3	KV1850.3	KE1850.3

Colori disponibili: (.52) Finitura ciliegio, (.53) Finitura faggio

Available colours: (.52) Cherry finish, (.53) Beech finish

			
Deviazione a T T-Joint	Coprigiunzione Cover joint	Terminale End piece	Traversa reggicavo Cable clamp
KT1022.52 KT1022.53	KV1022.52 KV1022.53	KE1022.52 KE1022.53	
KT1830.52 KT1830.53	KV1830.52 KV1830.53	KE1830.52 KE1830.53	KTR30

Scatole porta apparecchi 3 moduli
Socket boxes 3 modules italian standard

Articolo Item	Colori Colour	A mm	B mm	C mm
SP503	.1 .3 .5	134	51	95

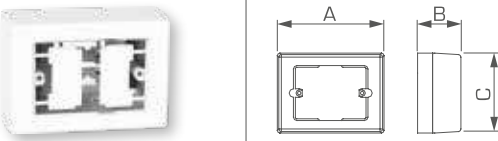

Scatole porta apparecchi 4 moduli
Socket boxes 4 modules italian standard

Articolo Item	Colori Colour	A mm	B mm	C mm
SP504	.3	159	51	93

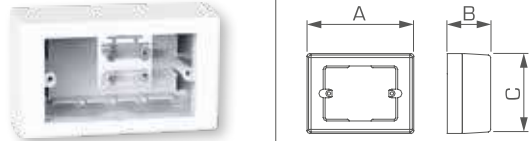

Scatole porta apparecchi monoblocco 3 moduli
Socket box 3 modules monobloc italian standard

Articolo Item	Colori Colour	A mm	B mm	C mm
SPM503	.3 .8 .52 .53	130	48	90

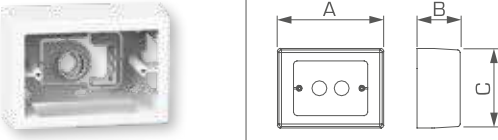

Scatole porta apparecchi monoblocco 4 moduli
Socket box 4 modules monobloc italian standard

Articolo Item	Colori Colour	A mm	B mm	C mm
SPM504	.3 .8	155	48	93

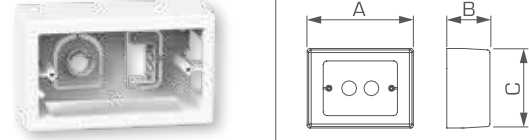

Scatole porta apparecchi monoblocco 7 moduli
Socket box 7 modules monobloc italian standard

Articolo Item	Colori Colour	A mm	B mm	C mm
SPM506	.3 .8	220	48	98

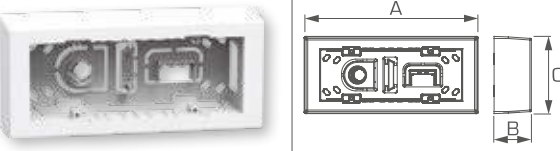

Scatole porta apparecchi 4-3 moduli
Socket boxes 4-3 modules italian standard

Articolo Item	Colori Colour	A mm	B mm	C mm
SPL504	.3	175	55	110

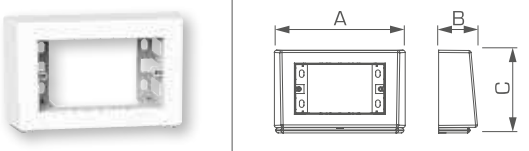

Scatola 2 moduli standard tedesco
Box 2 modules German standard

Articolo Item	Colori Colour	A mm	B mm	C mm
SPL502	.3	175	55	110

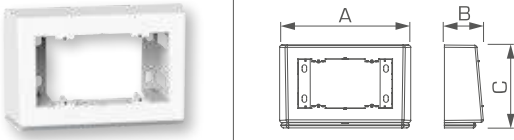

Scatole porta apparecchi 7 moduli
Socket boxes 7 modules italian standard

Articolo Item	Colori Colour	A mm	B mm	C mm
SPL506	.3	235	55	110

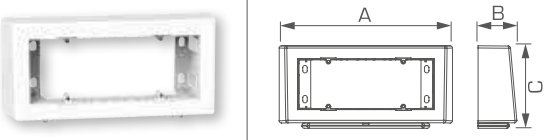

Placca cieca per scatole 3 moduli
Closed frame for boxes 3 modules italian standard

Articolo Item	Colori Colour	A mm	B mm	C mm
503C	.3.8	120	7	80

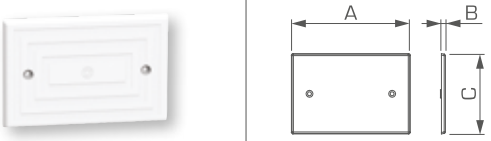

Placca cieca per scatole 4 moduli
Closed frame for boxes 4 modules italian standard

Articolo Item	Colori Colour	A mm	B mm	C mm
504C	.3.8	140	7	80

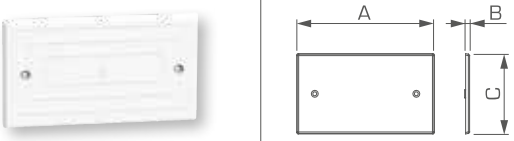

Placca cieca per scatole 7 moduli
Closed frame for boxes 7 modules italian standard

Articolo Item	Colori Colour	A mm	B mm	C mm
506C	.3.8	210	7	87



Cornice di rialzo per scatole incassate 3 moduli
Increase frame for embedded boxes 3 modules

Articolo Item	Colori Colour	B mm	C mm
L503	.3	12	82

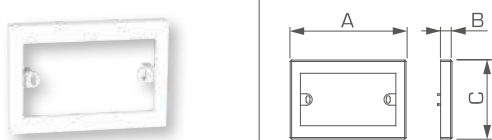

Adattatore per scatole
Adapter for boxes

Articolo Item	Colori disponibili Available colours	Per minicanali For minitrunkings
L22	.3	21x10 mm/30x10 mm



Scatola 1 modulo standard tedesco
Socket box 1 module german standard

Articolo Item	Colori Colour	A mm	B mm	C mm
SP60	.3	91	50	91

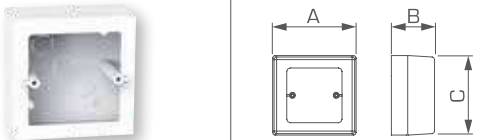

Scatola autoportante 2 moduli Gewiss System
Self-supporting box 2 modules Gewiss System

Articolo Item	Colori Colour	A mm	B mm	C mm
SP502G	.3	67	48	67

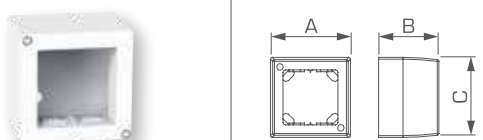

Scatola autoportante 4 moduli Gewiss System
Self-supporting box 4 modules Gewiss System

Articolo Item	Colori Colour	A mm	B mm	C mm
SP504G	.3	119	48	67

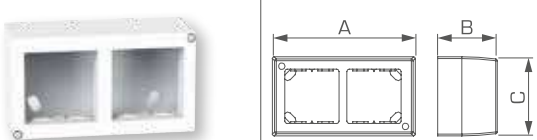

Scatola di derivazione per minicanali max H18 mm
Derivation box for mini trunking max H18 mm

Articolo Item	Colori Colour	A mm	B mm	C mm
SD553	.3 .5 .52 .53	65	30	65

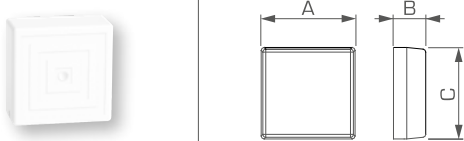

Scatola di derivazione per minicanali max H18 mm
Derivation box for mini trunking max H18 mm

Articolo Item	Colori Colour	A mm	B mm	C mm
SD554	.3 .5 .52 .53	90	35	90

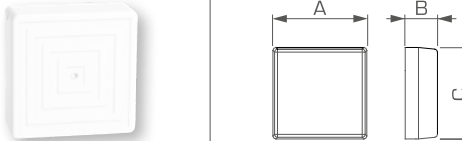

Scatola di derivazione per minicanali max H25 mm
Derivation box for mini trunking max H25 mm

Articolo Item	Colori Colour	A mm	B mm	C mm
SD503	.3	134	51	95

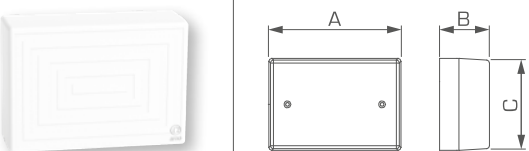

Derivazione tra minicanali e guaina spiralata
Derivation for minitrunkings and spiraled sheath

Articolo Item	Colori Colour	Per guaine For sheaths	A mm	B mm	C mm
L510	.3	Ø 12-16 mm	42	37	40

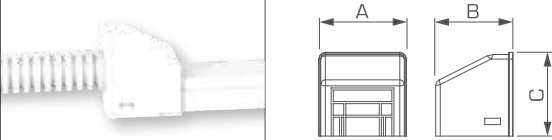

Compatibilità fra scatole e minicanali
Compatibility between boxes and minitrunkings

Minicanali Minitrunkings	Scatole porta apparecchi Socket boxes						Scatole di derivazione Derivation boxes		
	SP503	SP504	SPM503 SPM504 SPM506	SPL504 SPL506 SPL502	SP60	SP502G SP504G	SD553	SD554	SD503
10 x 10 mm			•						
21 x 10 mm	•	•	•	•	+	+	+	+	•
30 x 10 mm	•	•	•	•	+	+	+	+	•
15 x 15 mm	•		•				•		
18 x 18 mm	•	•	•	•	•	•	•	•	•
25 x 18 mm	•	•	•	•	•	•	•	•	•
30 x 18 mm	•	•	•	•	•	•	•	•	•
40 x 18 mm	•	•	•	•	•	•	•	•	•
50 x 18 mm	•	•	•	•	•	•	•	•	•
30 x 25 mm	•	•		•					•
30 x 30 mm	•				•	•			•
40 x 25 mm	•	•		•	•	•			•
40 x 40 mm		•		•	•				

+ Utilizzare l'adattatore articolo L22 - Use adapter item L22

Cesoia professionale per minicanali Professional cutting tool for minitrunkings

	Articolo Item	Per minicanali MAX For minitrunkings MAX
	KTC	50x18 mm
	KTCL	Lama di ricambio Replacement blade

Cesoia professionale per scatole Professional shearing tool for boxes

	Articolo Item	Descrizione Description
	910	Per il taglio di scatole e mostrine For boxes and frames

Dati tecnici Technical data

Coperchio standard Standard cover	Coperchio avvolgente Wrapping cover	Dimensioni esterne External dimensions	Sezioni scomparti mm ² Compartments mm ²				Ø Max inscrivibile Ø Max insertable mm			N. conduttori N07V-K N. cables N07V-K mm ²				
			1	2	3	TOT	1	2	3	1,5	2,5	4	6	
K1010		10 x 10 mm	89			89	8,9				6	3	3	1
K1022	KDU1022	21 x 10 mm	115			115	7				5	4	3	2
	KDU1030	30 x 10 mm	175			175	7				8	6	5	3
K1031		30 x 10 mm	75	75		150	7	7			6	5	3	2
K1515		15 x 15 mm	150			150	11				7	5	4	3
K1818	KDU1818	18 x 18 mm	215			215	13				11	7	5	4
K1825		25 x 18 mm	290			290	15				12	10	7	6
K1830	KDU1830	30 x 18 mm	385			385	16				20	13	11	8
K1831	KDU1831	30 x 18 mm	180	180		360	12	12			17	12	8	7
K1841		40 x 18 mm	245	245		490	15	15			24	16	12	8
	KDU1851	50 x 18 mm	315	315		630	15	15			33	20	15	12
K1852		50 x 18 mm	190	200	190	580	13	13	13		29	19	14	12
K2530		30 x 25 mm	545			545	22				29	20	15	12
K2540		40 x 25 mm	765			765	22				41	29	22	18
K2541		40 x 25 mm	345	345		690	17	17			34	23	18	14
K3030		30 x 30 mm	735			735	27				38	27	20	16
K4040		40 x 40 mm	1.255			1.255	35				64	44	35	27

Schema di foratura delle basi dei minicanali Punching drawings of minitrunkings bases

K1010 - K1022 - K1515 - K1818 - K1825 KDU1022 - KDU1030 - KDU1818		K1830 - K2530 - K2540 - K3030 - K4040 KDU1830			K1031 - K1831 - K1841 - K2541 KDU1831 - KDU1851	
A	Ø	A	B	C	A	Ø
125 mm	4 mm	125 mm	8 mm	4 mm	125 mm	4 mm

MINIKAPPA *Tape*

Sistema di minicanali
con pellicola adesiva e coperchio cernierato,
per applicazioni a parete e soffitto

Minitrunking system
with adhesive tape and hinged cover,
for wall and ceiling applications





Caratteristiche Tecniche

- Canale in PVC ed accessori in ABS
- Canale lunghezza standard 2 metri
- Apertura coperchio con attrezzo
- Resistenza all'urto IK 07 (2J)
- Grado di protezione IP40
- Tensione nominale 750V
- Temperatura di utilizzo -15°C +60°C

Technical Features

- PVC Trunkings and ABS accessories
- Trunking standard length 2 meters
- Cover disassembling with tool
- Mechanical protection IK 07 (2J)
- Protection degree IP40
- Rated voltage 750V
- Working temperature -15°C +60°C

Riferimenti a Norme

- Conforme alla norma CEI EN 50085-2-1
- Conforme alla Direttiva RoHS 2015/863/EU
- Conforme alla Direttiva B.T. 2009/95/CE

Norms Reference

- Complies with standard CEI EN 50085-2-1
- Compliant with RoHS Directive 2015/863/EU
- Compliant with the Low Voltage Directive 2009/95/EC

Marchi e Certificazioni

- Marcatura CE

Marks and Certifications

- CE marking

Colori disponibili

- Bianco RAL9010, Marrone RAL8014
Decorato faggio, Decorato ciliegio
Finitura faggio, Finitura ciliegio

Available colours

- White RAL9010, Brown RAL8014,
Decorated beech, Decorated cherry
Beech finish, Cherry finish

Minicanali porta cavi con pellicola adesiva e coperchio cernierato Minitrunkings with adhesive tape and hinged cover

							
Profilo Profile	Dimensioni B x H Dimensions B x H	Bianco White	Marrone Brown	Finitura Ciliegio Cherry finish	Finitura Faggio Beech finish	Decorato Ciliegio Cherry deco	Decorato Faggio Beech deco
	10x5 mm	LCD51.3					
	12x7 mm	LCD71.3	LCD71.5	LCD0712.52	LCD0712.53		
	10x10 mm	LCD86.3					
	15x10 mm	LCD94.3	LCD1015.5	LCD1015.52	LCD1015.53	LCD1015.CL	LCD1015.FG
	13x13 mm	LCD96.3	LCD96.5				
	21x10 mm	LCD98.3					
	17x17 mm	LCD101.3					

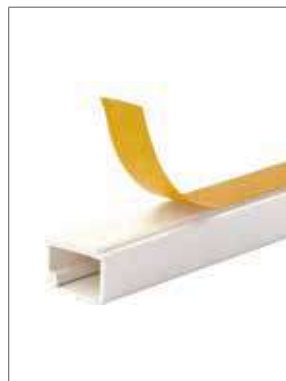

I minicanali hanno un potente adesivo sul fondo che aderisce perfettamente a superfici piatte.

The minitrunkings have a high quality adhesive tape that adheres perfectly to flat surfaces.



I minicanali hanno il coperchio cernierato con un coestruso di gomma, questo garantisce una chiusura sempre perfetta ed evita rotture accidentali durante l'apertura dello stesso.

The minitrunkings have the cover hinged with a coextruded rubber, that guarantees a perfect closing and it avoids the breaking during opening.

Accessori per minicanale 15x10 mm Accessories for minitrunking 15x10 mm

Profilo Profile	Dimensioni Dimensions	Angolo interno Internal angle	Angolo esterno External angle	Curva piana Flat angle	Deviazione a T T-Joint	Coprigiunzione Cover joint	Terminale End piece
	15x10 mm	KI1015.3 KI1015.CL KI1015.FG	KA1015.3 KA1015.CL KA1015.FG	KW1015.3 KW1015.CL KW1015.FG	KT1015.3 KT1015.CL KT1015.FG	KV1015.3 KV1015.CL KV1015.FG	KE1015.3 KE1015.CL KE1015.FG

Minicanali a "U" con pellicola adesiva, inserimento cavi a pressione "U" Minitrunkings with adhesive tape, press insertion of cables

Profilo Profile	Dimensioni Dimensions	Lunghezza Length	Canale Trunking	Diametro minimo/massimo cavo inseribile Diameter minimum/maximum insertable cable	
	8x6 mm	1,5 m	KC45	Ø 4 mm	Ø 5,5 mm
	10x7 mm	1,5 m	KC57	Ø 5 mm	Ø 7,5 mm
	11x9 mm	1,5 m	KC81	Ø 7 mm	Ø 9,5 mm
	12x10 mm	1,5 m	KC91	Ø 9 mm	Ø 11 mm



Dati tecnici Technical data

Minicanale Minitrunking	Dimensioni esterne External dimensions	Sezioni scomparti Compartments cross section mm ²				Ø Max inscrivibile Ø Max insertable mm			N. conduttori tipo N07V-K N. of insertable cables N07V-K mm ²			
		1	2	3	TOT	1	2	3	1,5	2,5	4	6
LCD51	10 x 5 mm	20			20	2,5			2	-	-	-
LCD71	12 x 7 mm	45			45	4,5			3	2	2	1
LCD0712	12 x 7 mm	45			45	4,5			3	2	2	1
LCD86	10 x 10 mm	60			60	6,5			5	3	2	2
LCD94	15 x 10 mm	95			95	8,0			7	5	5	3
LCD1015	15 x 10 mm	95			95	8,0			7	5	5	3
LCD96	13 x 13 mm	115			115	10			11	8	6	4
LCD98	21 x 10 mm	140			140	7,5			11	9	7	4
LCD101	17 x 17 mm	200			200	14			20	15	10	8

KAPPA

Sistema di canali di distribuzione
per applicazioni a parete e soffitto

Distribution trunking system
for wall and ceiling applications





Caratteristiche Tecniche

- Canale in PVC ed accessori in ABS
- Canale lunghezza standard 2 metri
- Apertura coperchio con attrezzo
- Resistenza all'urto IK08 (5J)
- Grado di protezione IP40
- Tensione nominale 750V
- Temperatura di utilizzo -15°C +60°C

Technical Features

- PVC Trunkings and ABS accessories
- Trunking standard length 2 meters
- Cover disassembling with tool
- Mechanical protection IK 08 (5J)
- Protection degree IP40
- Rated voltage 750V
- Working temperature -15°C +60°C

Riferimenti a Norme

- Conforme alla norma CEI EN 50085-2-1
- Conforme alla Direttiva RoHS 2015/863/EU
- Conforme alla Direttiva B.T. 2009/95/CE

Norms Reference

- Complies with standard CEI EN 50085-2-1
- Compliant with RoHS Directive 2015/863/EU
- Compliant with the Low Voltage Directive 2009/95/EC

Marchi e Certificazioni

- Marchio IMQ riferimento n° CA02.00112
- Marchio IMQ riferimento n° CA02.00113
- Marcatura CE

Marks and Certifications

- IMQ mark reference n° CA02.00112
- IMQ mark reference n° CA02.00113
- CE marking

Colori disponibili

- Grigio RAL7030, Bianco RAL9010

Available colours

- Grey RAL7030, White RAL9010



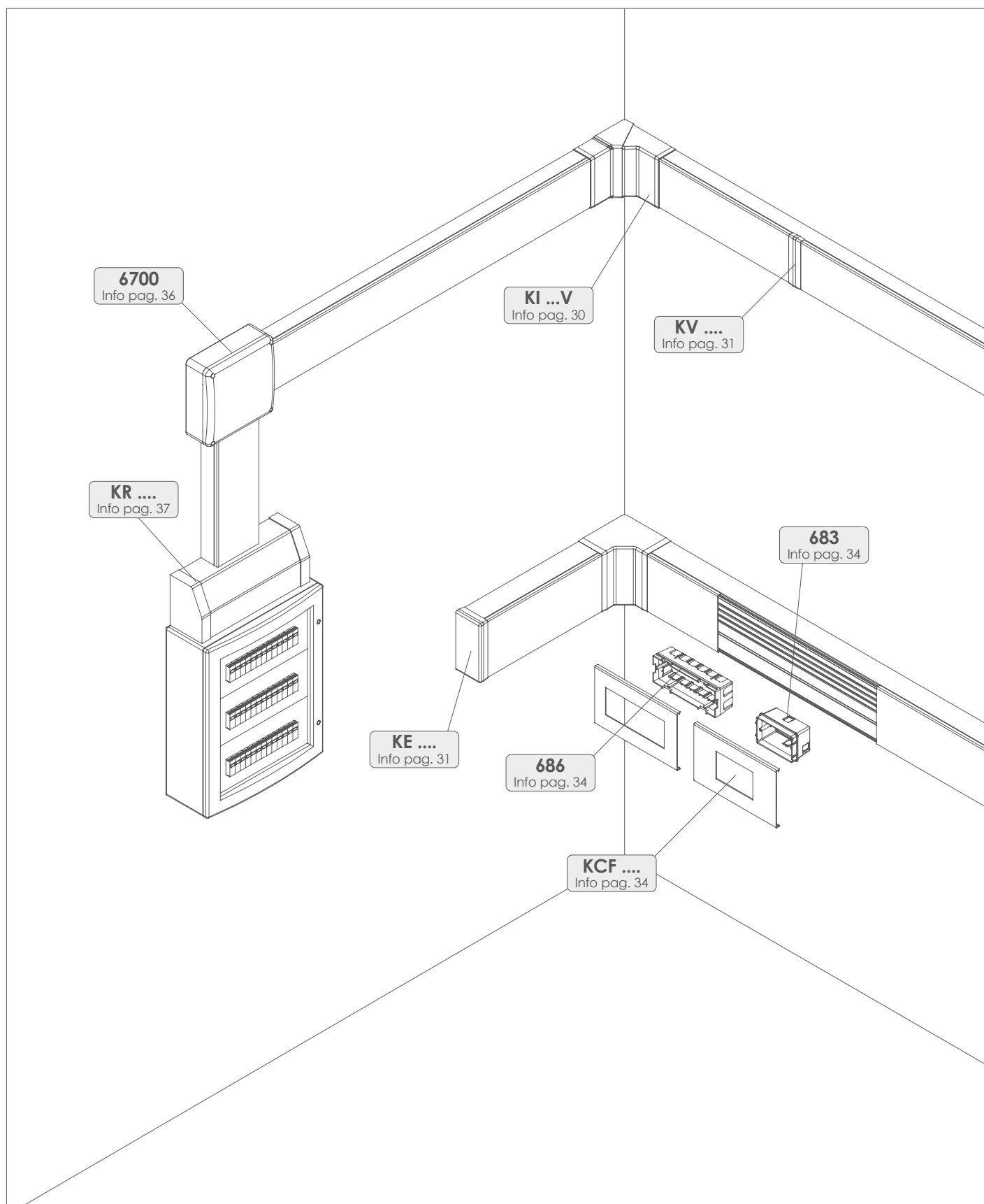



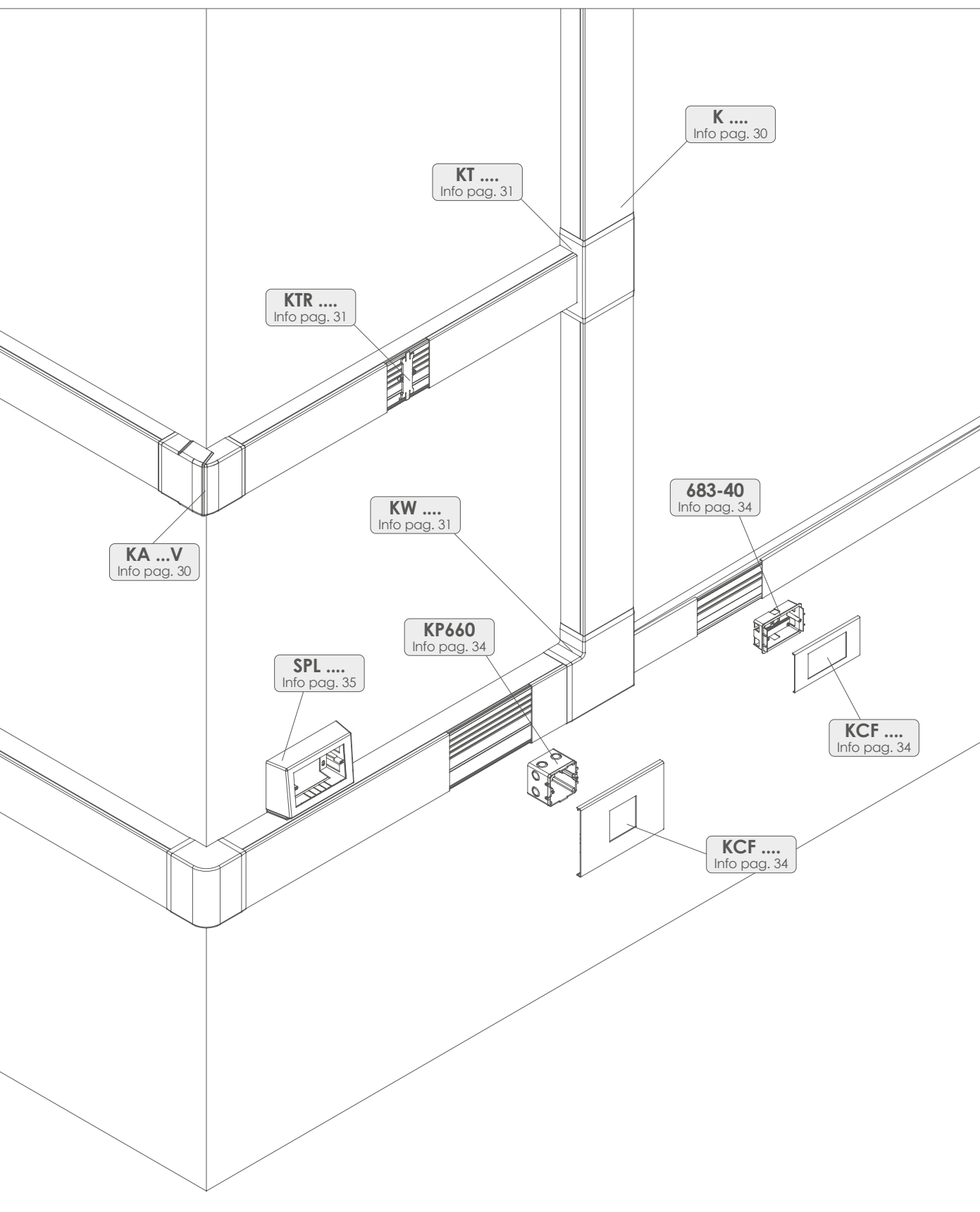









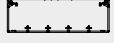

Esempio applicativo accessori Example of accessories application



Colori disponibili: (.1) Grigio RAL7030, (.3) Bianco RAL9010
Available colours: (.1) Grey RAL7030, (.3) White RAL9010









Canali porta cavi e porta apparecchi Cable trunking system

						
Profilo Profile	Dimensioni B x H Dimensions B x H	Scomparti Section	Canale e coperchio Trunking and cover	Separatore lunghezza 1 m Separator length 1 m	Angolo interno variabile Variable internal angle	Angolo esterno variabile Variable external angle
	60x40 mm	2	K4060.3 K4060.1	GTR40-1	KI4060V.3	KA4060V.3
	80x40 mm	3	K4080.3 K4080.1	GTR40-1	KI4080V.3	KA4080V.3
	100x40 mm	3	K40100.3 K40100.1	GTR40-1	KI40100V.3	KA40100V.3
	120x40 mm	5	K40120.3	GTR40-1	KI40120V.3	KA40120V.3
	60x60 mm	2	K6060.3 K6060.1	GTR60-1	KI6060V.3	KA6060V.3
	80x60 mm	3	K6080.3 K6080.1	GTR60-1	KI6080V.3	KA6080V.3
	100x60 mm	3	K60100.3 K60100.1	GTR60-1	KI60100V.3	KA60100V.3
	120x60 mm	5	K60120.3 K60120.1	GTR60-1	KI60120V.3	KA60120V.3
	150x60 mm	5	K60150.3 K60150.1	GTR60-1	KI60150V.3	KA60150V.3
	200x60 mm	7	K60200.3 K60200.1	GTR60-1	KI60200V.3 KI60200V.1	KA60200V.3 KA60200V.1
	250x60 mm	8	K60250.3 K60250.1	GTR60-1	KI60250V.3 KI60250V.1	KA60250V.3 KA60250V.1
	100x80 mm	3	K80100.3	GTR80-1	KI80100V.3	KA80100V.3
	120x80 mm	5	K80120.3	GTR80-1	KI80120V.3	KA80120V.3
	150x80 mm	5	K80150.3 K80150.1	GTR80-1	KI80150V.3 KI80150V.1	KA80150V.3 KA80150V.1
	200x80 mm	7	K80200.3 K80200.1	GTR80-1	KI80200V.3 KI80200V.1	KA80200V.3 KA80200V.1









Colori disponibili: (.1) Grigio RAL7030, (.3) Bianco RAL9010

Available colours: (.1) Grey RAL7030, (.3) White RAL9010

* Accessori preformati da canale vedi pagina 36 - Trunking preformed accessories see page 36

						
Angolo interno Internal angle	Angolo esterno External angle	Curva piana Flat angle	Deviazione a T T-Joint	Coprigiunzione Cover joint	Terminale End piece	Traversa reggicavo Cable clamp
KI4060.3 KI4060.1	KA4060.3 KA4060.1	KW4060.3 KW4060.1	KT4060R.3 KT4060R.1	KV60.3 KV60.1	KE4060.3 KE60.1	KTR60
KI4080.3 KI4080.1	KA4080.3 KA4080.1	KW4080.3 KW4080.1	KT4080R.3 KT4080R.1	KV80.3 KV80.1	KE80.3 KE80.1	KTR80
KI40100.3 KI40100.1	KA40100.3 KA40100.1	KW40100.3 KW40100.1	KT40100R.3 KT40100R.1	KV100.3 KV100.1	KE100.3 KE100.1	KTR100
KI40120.3	KA40120.3	KW40120.3	KT40120.3 *	KV120.3	KE120.3	KTR120
KI6060.3 KI6060.1	KA6060.3 KA6060.1	KW6060.3 KW6060.1	KT6060R.3 KT6060R.1	KV60.3 KV60.1	KE60.3 KE60.1	KTR60
KI6080.3 KI6080.1	KA6080.3 KA6080.1	KW6080.3 KW6080.1	KT6080R.3 KT6080R.1	KV80.3 KV80.1	KE80.3 KE80.1	KTR80
KI60100.3 KI60100.1	KA60100.3 KA60100.1	KW60100.3 KW60100.1	KT60100R.3 KT60100R.1	KV100.3 KV100.1	KE100.3 KE100.1	KTR100
KI60120.3 KI60120.1	KA60120.3 KA60120.1	KW60120.3 KW60120.1	KT60120.3 * KT60120.1 *	KV120.3 KV120.1	KE120.3 KE120.1	KTR120
KI60150.3 KI60150.1	KA60150.3 KA60150.1	KW60150.3 KW60150.1	KT60150.3 * KT60150.1 *	KV150.3 KV150.1	KE150.3 KE150.1	KTR150
		KW60200.3 KW60200.1	KT60200.3 * KT60200.1 *	KV200.3 KV200.1	KE200.3 KE200.1	KTR200
		KW60250.3 KW60250.1	KT60250.3 * KT60250.1 *	KV250.3 KV250.1	KE60250.3 KE60250.1	KTR250
		KW80100.3	KT80100.3 * KT80100.1 *	KV100.3 KV100.1	KE80100.3	KTR100
		KW80120.3	KT80120.3 * KT80120.1 *	KV120.3 KV120.1	KE80120.3	KTR120
		KW80150.3 KW80150.1	KT80150.3 * KT80150.1 *	KV150.3 KV150.1	KE150.3 KE150.1	KTR150
		KW80200.3 KW80200.1	KT80200.3 * KT80200.1 *	KV200.3 KV200.1	KE200.3 KE200.1	KTR200

Canali porta cavi con passanti sul fondo Cable trunking system with loops on the bottom

						
Profilo Profile	Dimensioni B x H Dimensions B x H	Scomparti Section	Canale e coperchio Trunking and cover	Angolo interno variabile Variable internal angle	Angolo esterno variabile Variable external angle	Curva piana Flat angle
	60x40 mm	1	K04060.3	KI4060V.3	KA4060V.3	KW4060.3
	80x40 mm	1	K04080.3	KI4080V.3	KA4080V.3	KW4080.3
	60x60 mm	1	K06060.3	KI6060V.3	KA6060V.3	KW6060.3
	80x60 mm	1	K06080.3	KI6080V.3	KA6080V.3	KW6080.3
	100x60 mm	1	K060100.3	KI60100V.3	KA60100V.3	KW60100.3



Colori disponibili: (.3) Bianco RAL9010

Available colours: (.3) White RAL9010

					
Angolo interno Internal angle	Angolo esterno External angle	Deviazione a T T-Joint	Coprigiunzione Cover joint	Terminale End piece	Traversa reggicavo Cable clamp
KI4060.3	KA4060.3	KT4060R.3	KV60.3	KE4060.3	KTR60
KI4080.3	KA4080.3	KT4080R.3	KV80.3	KE80.3	KTR80
KI6060.3	KA6060.3	KT6060R.3	KV60.3	KE60.3	KTR60
KI6080.3	KA6080.3	KT6080R.3	KV80.3	KE80.3	KTR80
KI60100.3	KA60100.3	KT60100R.3	KV100.3	KE100.3	KTR100



Scatola 3 moduli per canali H40 mm
Socket box 3 modules for trunkings H40 mm

Articolo Item	A mm	B mm	C mm	D mm
683-40	103	36	68	83,5

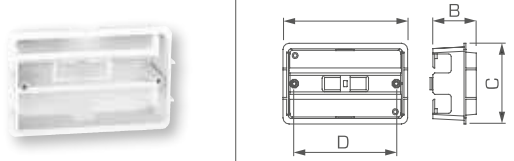

Scatola 3 moduli per canali H60 mm
Socket box 3 modules for trunkings H60 mm

Articolo Item	A mm	B mm	C mm	D mm
683	103	50	68	83,5

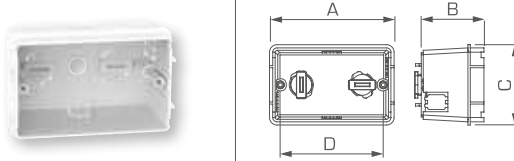

Scatola 3-4-7 moduli per canali H60 mm
Socket box 3-4-7 modules for trunkings H60 mm

Articolo Item	A mm	B mm	C mm	D mm	E mm	F mm
686	175	50	68	83,5	108,5	100

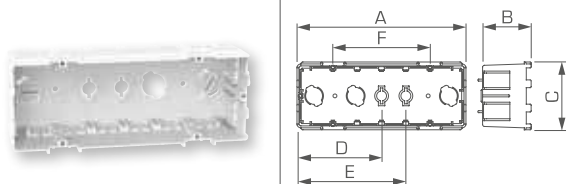

Kit per montaggio scatola 686 su canali H80 mm
Kit for mounting box 686 on trunkings H80 mm

Articolo Item
K686H80



Scatola 2 moduli per canali H60 mm
Socket box 2 modules for trunkings H60 mm

Articolo Item	Colori Colour	A mm	B mm	C mm	D mm
KP660	.3	70	70	60	60

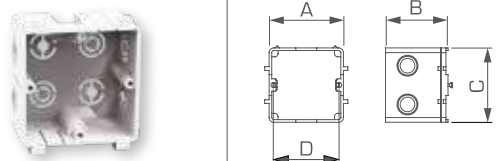

Mostrine per scatole porta apparecchi
Frames for socket boxes

Articolo Item	A mm	B mm	Per scatole For boxes
KCF80-53R.3	133	80	683-40 - 683 - 686 - 680
KCF100-53.3	212	100	683-40 - 683 - 686 - 680
KCF120-53.3	212	120	683-40 - 683 - 686 - 680
KCF150-53.3	212	150	683-40 - 683 - 686 - 680
KCF200-53.3	212	200	683-40 - 683 - 686 - 680

Mostrine per scatola SP660
Frames for socket box SP660

Articolo Item	A mm	B mm	Per scatole For boxes
KCF100-D1.3	120	100	SP660
KCF150-D1.3	120	150	SP660

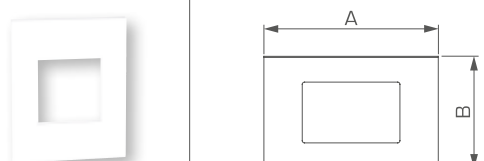

Le mostrine hanno un'apertura per 3 moduli e la pretranciatura per 4-5 e 7 moduli
The frames have a hole for 3 modules and a precutting for 4-5 and 7 modules

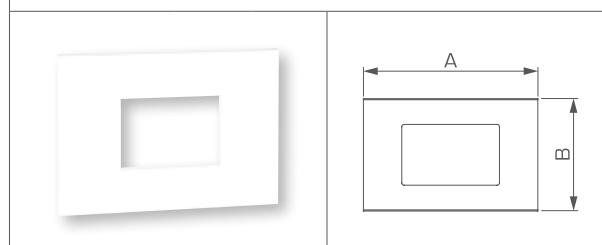

Scatola porta apparecchi 4-3 moduli Socket box 4-3 modules italian standard

Articolo Item	Interasse D Centres D	A mm	B mm	C mm
SPL504.3	108,5 (83,5)	175	55	110

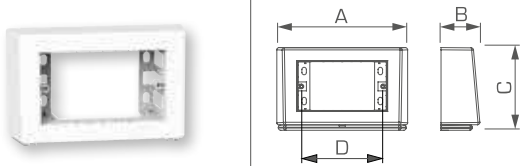

Scatola porta apparecchi 2 mod standard tedesco Socket box 2 modules german standard

Articolo Item	D1xD2 mm	A mm	B mm	C mm
SPL502.3	71x60	175	55	110

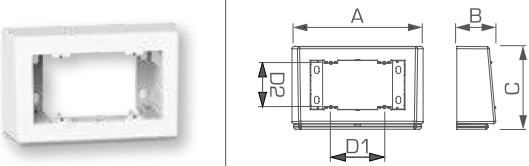

Scatola porta apparecchi 7 moduli Socket box 7 modules italian standard

Articolo Item	D1xD2 mm	A mm	B mm	C mm
SPL506.3	100x60	235	55	110

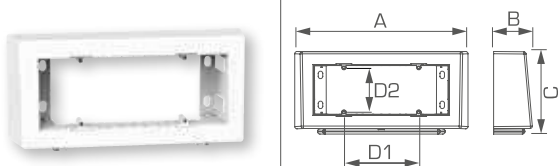

Supporto per apparecchi modulari Support for modular switches

Articolo Item	Descrizione Description
605	Supporto da 1 a 8 moduli da 17,5 mm Support from 1 to 8 modules of 17,5 mm
KCF120-05	Mostrina per canale larghezza 120 mm Frame for trunking width 120 mm
KCF150-05	Mostrina per canale larghezza 150 mm Frame for trunking width 150 mm



Dima di foratura canale per giunti Drilling template for trunkings joints

Articolo Item
905



Giunti lineari a scatto Click linear joints

Articolo Item	A mm	B mm	C mm	D mm
445GL	100	50	7	9
645GL	100	50	7	9
845GL	100	50	7	9

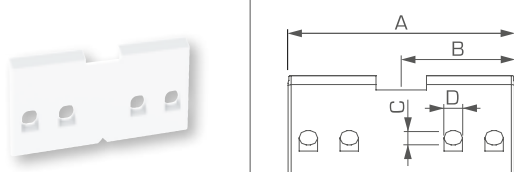

Per una tenuta migliore usare le viti in nylon M610
For a better installation use the nylon screws item M610

Vite con dado cieco in Nylon, per giunti Nylon screw with blind nut, for joints

Articolo Item	Colori Colour	A mm	B mm	C mm	D mm
M610	.1 .3	12,5	14	10	6

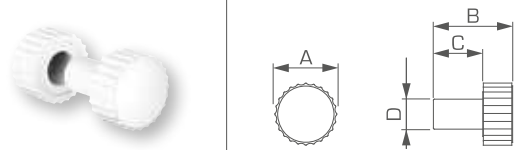

Scatola di derivazione con separatore
Derivation box with separator

Articolo Item	Colori Colour	A mm	B mm	C mm
6700S	.1 .3	115	53	115
6701S	.1 .3	155	100	155
6702S	.1 .3	200	100	200
6703S	.1 .3	280	100	280

Scatola di derivazione senza separatore
Derivation box without separator

Articolo Item	Colori Colour	A mm	B mm	C mm
6700	.3	115	53	115
6701	.3	155	100	155
6702	.3	200	100	200
6703	.3	280	100	280

Scatola di derivazione con barre equipotenziali
Derivation box with equipotential bars

Articolo Item	Fori/dimensione barre Holes/bar dimension	A mm	B mm	C mm
6700BT12.3	12 x M5 - 12x2 mm	115	53	115
6701BT20.3	20 x M5 - 12x2 mm	155	80	155
6702BT34.3	34 x M5 - 12x2 mm	200	80	200

Deviazione a T prefornata
Preformed T-joint

Articolo Item	Colori Colour	A mm	B mm	C mm
KT40120	.1 .3	370	245	125
KT60120	.1 .3	370	245	125
KT60150	.1 .3	430	290	140
KT60200	.1 .3	480	340	140
KT60250	.1 .3	520	385	135
KT80100	.1 .3	360	230	130
KT80120	.1 .3	370	245	125
KT80150	.1 .3	430	290	140
KT80200	.1 .3	480	340	140

Scatola di derivazione con morsetti
Derivation box with equipotential terminal

Articolo Item	N. e dimensione fori N. Holes and dimension	A mm	B mm	C mm
6700TE14.3	4 x 16 mm ² - 10 x 10 mm ²	115	53	115
6701TE28.3	4 x 16 mm ² - 26 x 10 mm ²	155	80	155
6702TE56.3	8 x 16 mm ² - 52 x 10 mm ²	200	80	200

Il numero delle morsettiere può essere aumentato vedi pag 245
The number of terminals can be increased see pag 245

Supporto di tenuta per traverse reggicavo
Stiffening rest for cable clamps

Articolo Item	Per canali For trunkings
KRT40	H 40
KRT60	H 60
KRT80	H 80

Distanziatore da pavimento a larghezza variabile Floor spacer with variable width

Articolo Item	Larghezza variabile Variable width	A mm
KDP60250	Per canali da 60 a 250 mm For trunkings from 60 to 250 mm	10

Staffa in plastica Wall plastic bracket

Articolo Item	Colori Colour	A mm	B mm	C mm	D mm
633-2	.3	150	130	157	168
633-3	.1 .3	230	200	157	249

Allineatore per canali Aligner for trunkings

Articolo Item	Descrizione Description			
KAL	Allineatore per tratti rettilinei, angoli interni e angoli esterni Aligner for straight sections, internal and external angles			

Derivazione per quadri elettrici Panel derivation

Articolo Item	A mm	B mm	C mm	D mm	
KR150550.3	150	550	75	110	
KR150800.3	150	800	75	110	

Schema di foratura delle basi dei canali K0 Punching drawings of K0 trunkings bases

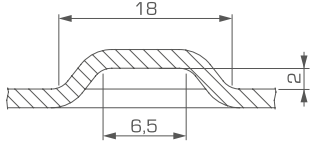
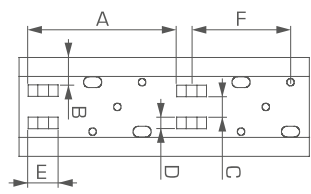
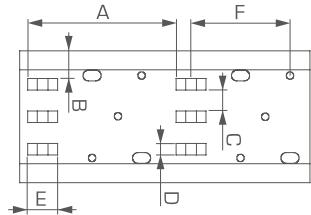
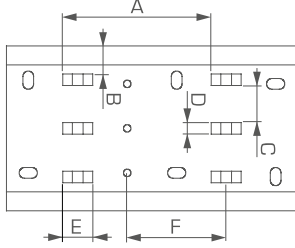
Articolo Item	A mm	B mm	C mm	D mm	E mm	F mm	Dimensioni passanti mm Loops dimensions mm
K04060	90	16,8	12,4	7	18	60	
K04080	90	16,8	12,7	7	18	60	
K06060	90	16,8	12,4	7	18	60	
K06080	90	16,8	12,7	7	18	60	
K060100	90	17	22,5	7	18	60	
Larghezza 60 mm Width 60 mm			Larghezza 80 mm Width 80 mm			Larghezza 100 mm Width 100 mm	
							

Compatibilità fra scatole porta apparecchi e canali Compatibility between socket boxes and trunkings

Articolo Item	683-40	683	686	680	SPL504	SPL506	KP660
K4060					x	x	
K4080	x				x	x	
K40100	x				x	x	
K40120	x				x	x	
K6060					x	x	
K6080					x	x	x
K60100		x	x	x	x	x	x
K60120		x	x	x	x	x	x
K60150		x	x	x	x	x	x
K60200		x	x	x	x	x	x
K60250		x	x	x	x	x	x
K80100				x	x	x	
K80120				x	x	x	
K80150				x	x	x	
K80200				x	x	x	

Dati tecnici dei canali Kappa Kappa trunkings data table

Articolo Item	Scomparti Separations	Sezioni scomparti mm ² Compartments cross section mm ²									Sezione totale Total section
		1	2	3	4	5	6	7	8	TOT	
K4060	2	940	940							1.880	1.960 mm ²
K4080	3	865	780	865						2.510	2.675 mm ²
K40100	3	1230	780	1.230						3.240	3.400 mm ²
K40120	5	720	780	780	780	720				3.780	4.100 mm ²
K6060	2	1.465	1.465							2.930	3.060 mm ²
K6080	3	1.355	1.200	1.355						3.910	4.170 mm ²
K60100	3	1.895	1.195	1.895						4.985	5.250 mm ²
K60120	5	1.115	1.195	1.195	1.195	1.115				5.815	6.340 mm ²
K60150	5	1.925	1.190	1.190	1.190	1.925				7.420	7.945 mm ²
K60200	7	1.965	1.185	1.185	1.185	1.185	1.185	1.965		9.855	10.645 mm ²
K60250	8	2.010	1.185	1.850	1.185	1.185	1.850	1.185	2.010	12.460	13.360 mm ²
K80100	2	4.327	2.887							7.135	7.215 mm ²
K80120	3	2.965	2.775	2.965						8.550	8.710 mm ²
K80150	5	2.620	1.615	1.615	1.615	2.620				10.085	10.825 mm ²
K80200	7	2.675	1.610	1.610	1.610	1.610	1.610	2.675		13.400	14.505 mm ²

Dati tecnici dei canali K0 K0 trunkings data table

Articolo canali Trunkings item	Numero file passanti Loops lines Number	Dimensioni Dimensions	Sezioni scomparti mm ² Compartments cross section mm ²				Sezione totale senza separatori Total section without separators
			1	2	3	TOT	
K04060	2	60 x 40 mm	940	940		1.880	1.960 mm ²
K04080	3	80 x 40 mm	865	780	865	2.510	2.675 mm ²
K06060	2	60 x 60 mm	1.465	1.465		2.930	3.060 mm ²
K06080	3	80 x 60 mm	1.355	1.200	1.355	3.910	4.170 mm ²
K060100	3	100 x 60 mm	1.895	1.195	1.895	4.985	5.250 mm ²

Canali derivabili dalle derivazioni a T Derivable trunkings from T-derivations

Articolo Item	Canali derivabili Derivable trunkings							
	40x25 mm	40x40 mm	60x40 mm	80x40 mm	100x40 mm	60x60 mm	80x60 mm	100x60 mm
KT4060R	•	•	•					
KT4080R	•	•	•	•				
KT40100R	•	•	•	•	•			
KT6060R	•	•	•			•		
KT6080R	•	•	•	•		•	•	
KT60100R	•	•	•	•	•	•	•	•

Compatibilità fra scatole di derivazione e canali Compatibility between derivation boxes and trunkings

Articolo canali Trunkings item	6700 6700S	6700TE14 6700BT12	6701S	6701 6701TE28 6701BT20	6702S	6702 6702TE56 6702BT34	6703S	6703
K4060	•	•	•	•	•	•	•	•
K4080	•	•	•	•	•	•	•	•
K40100	•	•	•	•	•	•	•	•
K40120			•	•	•	•	•	•
K6060			•	•	•	•	•	•
K6080			•	•	•	•	•	•
K60100			•	•	•	•	•	•
K60120					•	•	•	•
K60150					•	•	•	•
K60200							•	•
K60250							•	•
K80100			•		•		•	
K80120					•		•	
K80150					•		•	
K80200							•	

Schema di foratura delle basi dei canali KAPPA Punching drawings of KAPPA trunkings bases

Articolo Item	A mm	B mm	C mm	D mm	E mm	Ø F mm	G mm	H mm	I mm	
K4060	60	30	30	6,5	11,00	4,5				
K4080	60	30	15	6,5	11,00	4,5	25	25		
K40100	90	30	30	6,5	11,00	4,5	27	27	3,25	
K40120	60	30	48	6,5	11,00	4,5				
K6060	60	30	30	6,5	11,00	4,5				
K6080	60	30	15	6,5	11,00	4,5	25	25		
K60100	90	30	30	6,5	11,00	4,5	27	27	3,25	
K60120	60	30	48	6,5	11,00	4,5				
K60150	90	30	30	6,5	11,00	4,5	104			
K60200	90	30	30	6,5	11,00	4,5	152			
K60250	90	30	30	6,5	11,00	4,5	59	84	59	
K80100	90	30	30	6,5	11,00	4,5	27	27	3,25	
K80120	60	30	48	6,5	11,00	4,5				
K80150	90	30	30	6,5	11,00	4,5	104			
K80200	90	30	30	6,5	11,00	4,5	152			
Larghezza 60 mm Width 60 mm			Larghezza 80-110 mm Width 80-100 mm				Larghezza 120 mm Width 120 mm			
Larghezza 150-200 mm Width 150-200 mm					Larghezza 250 mm Width 250 mm					

SPACE

Sistema di canali di distribuzione
per applicazioni a parete o soffitto

Parapet trunking system
for wall or ceiling installations





Caratteristiche Tecniche

- Canale in PVC ed accessori in ABS
- Canale lunghezza standard 2 metri
- Apertura coperchio con attrezzo
- Resistenza all'urto IK08 (5J)
- Grado di protezione IP40
- Tensione nominale 750V
- Temperatura di utilizzo -15°C +60°C

Technical Features

- PVC Trunkings and ABS accessories
- Trunking standard length 2 meters
- Cover disassembling with tool
- Mechanical protection IK 08 (5J)
- Protection degree IP40
- Rated voltage 750V
- Working temperature -15°C +60°C

Riferimenti a Norme

- Conforme alla norma CEI EN 50085-2-1
- Conforme alla Direttiva RoHS 2015/863/EU
- Conforme alla Direttiva B.T. 2009/95/CE

Norms Reference

- Complies with standard CEI EN 50085-2-1
- Compliant with RoHS Directive 2015/863/EU
- Compliant with the Low Voltage Directive 2009/95/EC

Marchi e Certificazioni

- Marchio IMQ riferimento n° EE897
- Marcatura CE

Marks and Certifications

- Mark IMQ reference n° EE897
- CE marking

Colori disponibili

- Bianco RAL9010

Available colours

- White RAL9010



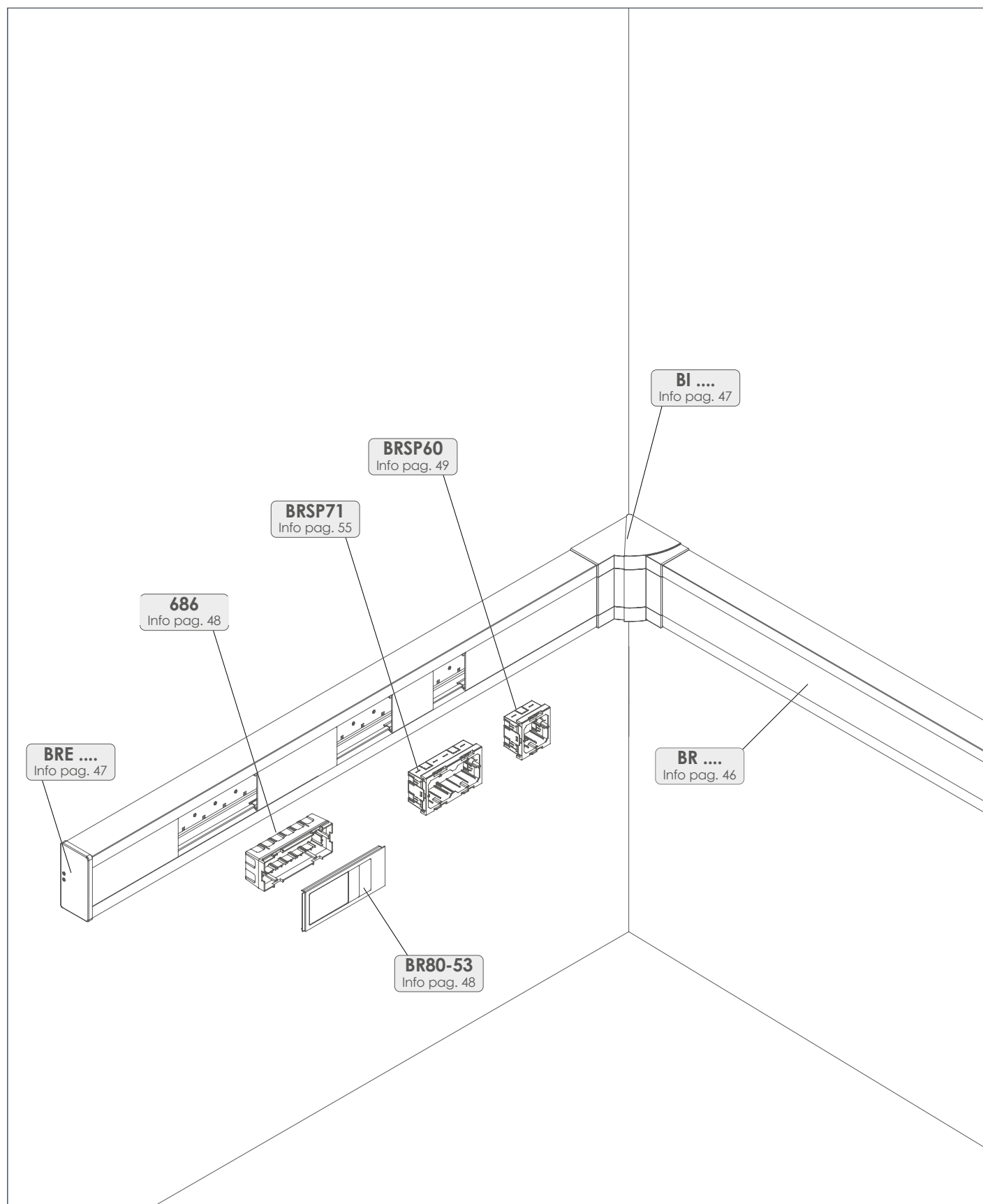

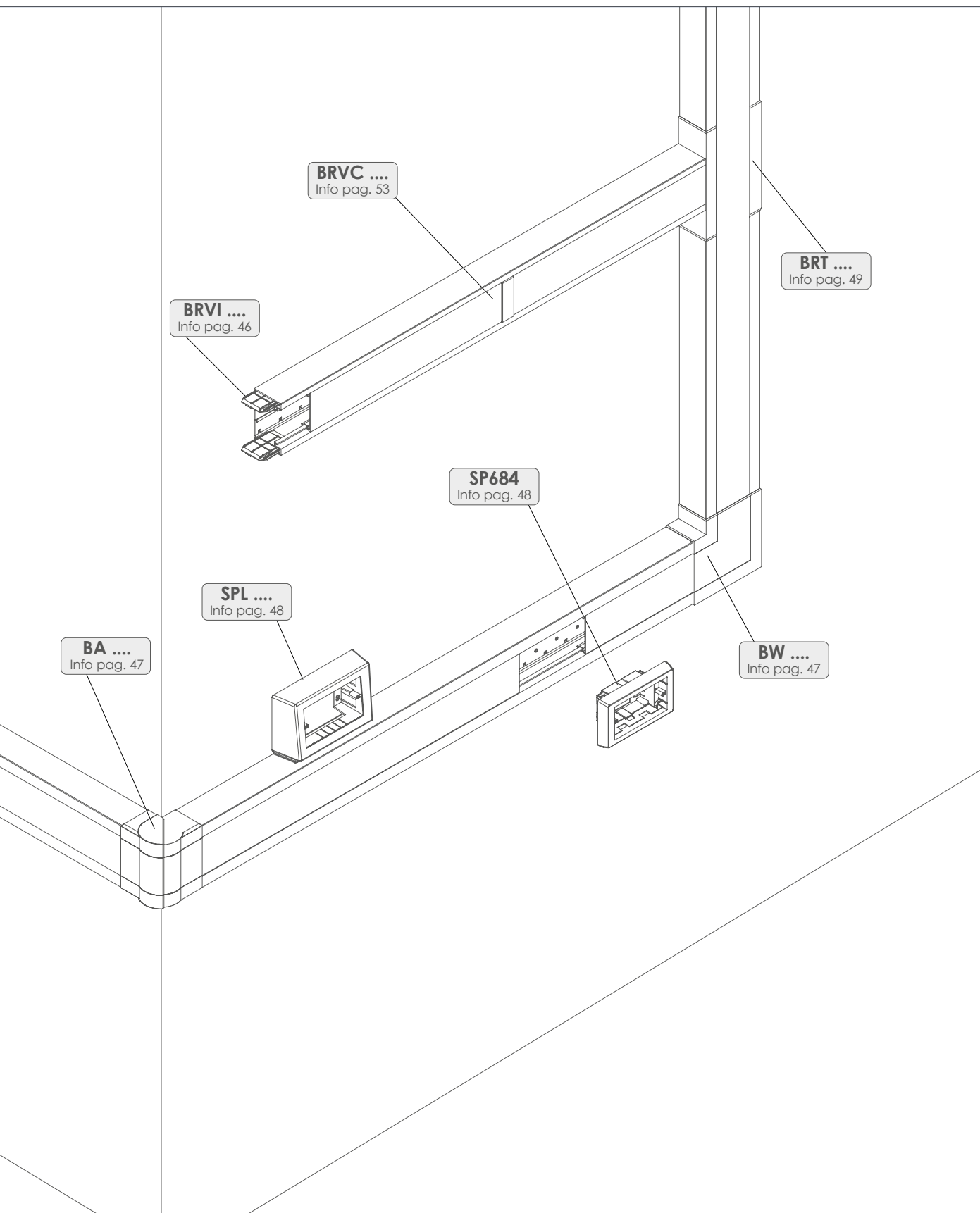

Esempio applicativo accessori Example of accessories application



Colori disponibili: (.3) Bianco RAL9010
Available colours: (.3) White RAL9010



Canali di distribuzione in pvc Parapet trunking system of pvc

					
Profilo Profile	Dimensioni B x H Dimensions B x H	Scomparti Section	Canale e coperchio Trunking and cover	Separatore Separator	Giunto lineare interno Internal linear joint
	100x65 mm	3	BR65100.3	KSTR60	BRVI65
	130x65 mm	3	BR65130.3	KSTR60	BRVI65
	170x65 mm	3	BR65170.3	KSTR60	BRVI65
	210x65 mm	6	BR65210-2.3	KSTR60	BRVI65



Colori disponibili: (.3) Bianco RAL9010
Available colours: (.3) White RAL9010

Angolo interno variabile Variable internal angle	Angolo esterno variabile Variable external angle	Curva piana Flat angle	Derivazione preformata Preformed derivation	Coprigiunzione Cover joint	Terminale End piece
BI65100V.3	BA65100V.3	BW65100.3	BRT65100.3	BSVO80.3	BRE65100.3
BI65130V.3	BA65130V.3	BW65130.3	BRT65130.3	BSVO80.3	BRE65130.3
BI65170V.3	BA65170V.3	BW65170.3	BRT65170.3	BSVO80.3	BRE65170.3
BI65210V.3	BA65210V.3	BW65210.3	BRT65210.3	BSVO80.3	BRE65210.3



Scatola 3 moduli per canali H60 mm
Socket box 3 modules for trunkings H60 mm

Articolo Item	A mm	B mm	C mm	D mm
683	103	50	68	83,5

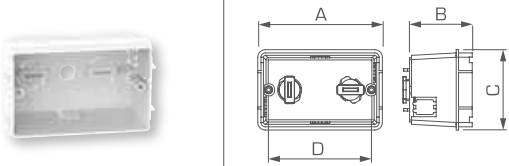

Scatola 3-4-7 moduli per canali H60 mm
Socket box 3-4-7 modules for trunkings H60 mm

Articolo Item	A mm	B mm	C mm	D mm	E mm	F mm
686	175	50	68	83,5	108,5	100

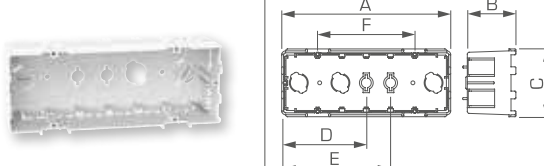

Mostrina per scatole 683 e 686
Plastic frame for boxes 683 and 686

Articolo Item	A mm	B mm	C mm	D mm
BR80-53	210	80	83,5 - 108,5 - 100	64

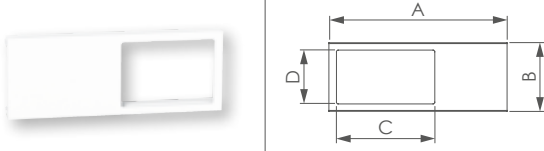

Scatola porta apparecchi 4-3 moduli
Socket box 4-3 modules italian standard

Articolo Item	Interasse D Centres D	A mm	B mm	C mm
SPL504.3	108,5 (83,5)	175	55	110

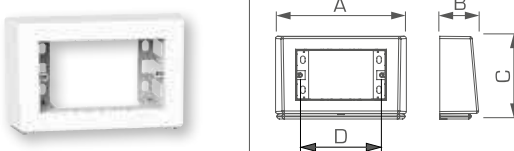

Scatola porta apparecchi 7 moduli
Socket box 7 modules italian standard

Articolo Item	D1xD2 mm	A mm	B mm	C mm
SPL506.3	100x60	235	55	110

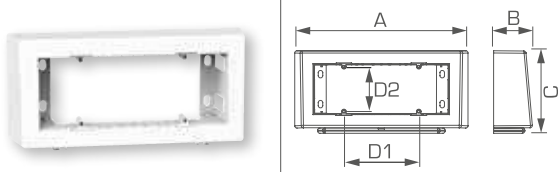

Scatola porta apparecchi 2 mod standard tedesco
Socket box 2 modules german standard

Articolo Item	D1xD2 mm	A mm	B mm	C mm
SPL502.3	71x60	175	55	110

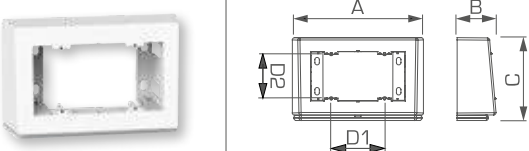

Scatola 4 moduli semi-incassata
Semi-embedded socket box 4 modules

Articolo Item	Moduli Modules	A mm	B mm	C mm	D mm
SP684.3	4	122	54	83	108,5

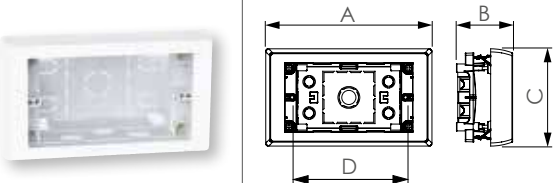

Mostrina autoportante per SPL504 e SP684
Self-supporting frame for SPL504 and SP684

Articolo Item	Tipo moduli Modules type	A mm	B mm	C mm
SF504L.3	4 mod Living-Light	122	54	83
SF502-45.3	2 mod 45x45	122	54	83

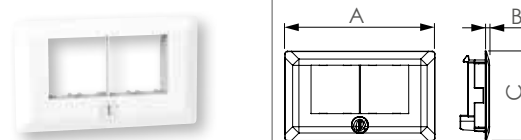

Scatola di derivazione con morsettiere Derivation box with equipotential terminal

Articolo Item	N. e dimensione fori N. Holes and dimension	A mm	B mm	C mm
6700TE14.3	4 x 16 mm ² - 10 x 10 mm ²	115	53	115
6701TE28.3	4 x 16 mm ² - 26 x 10 mm ²	155	80	155
6702TE56.3	8 x 16 mm ² - 52 x 10 mm ²	200	80	200

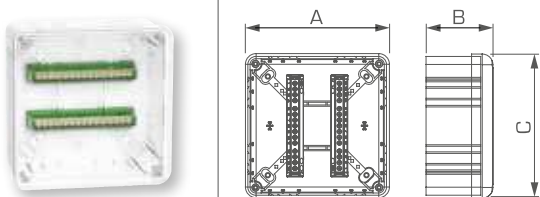

Il numero delle morsettiere può essere aumentato vedi pag 245
The number of terminals can be increased see pag 245

Scatola di derivazione con separatore Derivation box with separator

Articolo Item	A mm	B mm	C mm
6700S.3	115	53	115
6701S.3	155	100	155
6702S.3	200	100	200
6703S.3	280	100	280

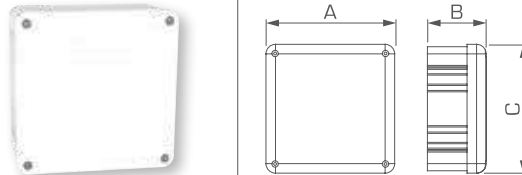

Scatola 1 modulo standard tedesco Socket box 1 module german standard

Articolo Item	A mm	B mm	C mm	D mm
BRSP60	71	47	80	60

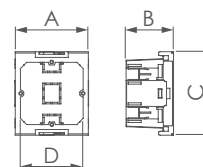

Scatola 2 moduli standard tedesco Socket box 2 modules german standard

Articolo Item	A mm	B mm	C mm	D mm	E mm
BRSP71	142	47	80	60	71

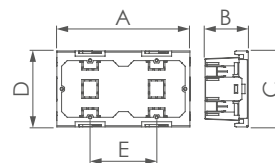

Deviazione a T preformata Preformed T-Joint

Articolo Item	A mm	C mm	D mm	E mm	F mm
BRT65100.3	245	65	100	80	28
BRT65130.3	245	65	130	80	28
BRT65170.3	245	65	170	135	40
BRT65210.3	245	65	210	135	40

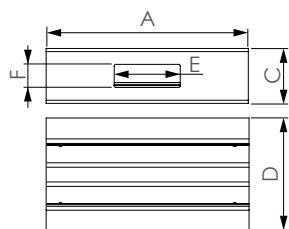

Dati tecnici dei canali Trunking data table

Articolo Item	Scomparti Separations	Sezioni scomparti mm ² Compartments cross section mm ²							Sezione totale Total section
		1	2	3	4	5	6	TOT	
BR65100	3	1.887	1.220	1.876				4.983	5.446 mm ²
BR65130	3	2.784	1.220	2.772				6.776	7.239 mm ²
BR65170	3	3.984	1.220	3.972				9.176	9.639 mm ²
BR65210-2	6	2.007	1.220	2.225	2.267	1.220	1.996	10.965	11.890 mm ²

ALUSPACE

Sistema di canali di distribuzione in ALLUMINIO
per applicazioni a parete e soffitto

Aluminium parapet trunking system
for wall and ceiling installation





Caratteristiche Tecniche

- Canale in Alluminio
- Accessori in Alluminio o ABS verniciato alluminio
- Canale lunghezza standard 2 metri
- Apertura coperchio con attrezzo
- Resistenza all'urto IK08 (5J)
- Grado di protezione IP40
- Tensione nominale 750V

Technical Features

- Aluminium trunking
- Accessories of aluminium or of ABS aluminium painted
- Trunking standard length 2 meters
- Cover disassembling with tool
- Mechanical protection IK08 (5J)
- Protection degree IP40
- Rated voltage 750V

Riferimenti a Norme

- Conforme alla norma CEI EN 50085-2-1
- Conforme alla Direttiva RoHS 2015/863/EU
- Conforme alla Direttiva B.T. 2009/95/CE

Norms Reference

- Complies with standard CEI EN 50085-2-1
- Compliant with RoHS Directive 2015/863/EU
- Compliant with the Low Voltage Directive 2009/95/EC

Marchi e Certificazioni

- Marchio IMQ riferimento n° EE899
- Marcatura CE

Marks and Certifications

- IMQ mark reference n° EE899
- CE marking

Colori disponibili

- Alluminio anodizzato, Alluminio nero, Alluminio bianco

Available colours

- Anodized aluminium, Black aluminium, White aluminium

Esempio applicativo accessori Example of accessories application

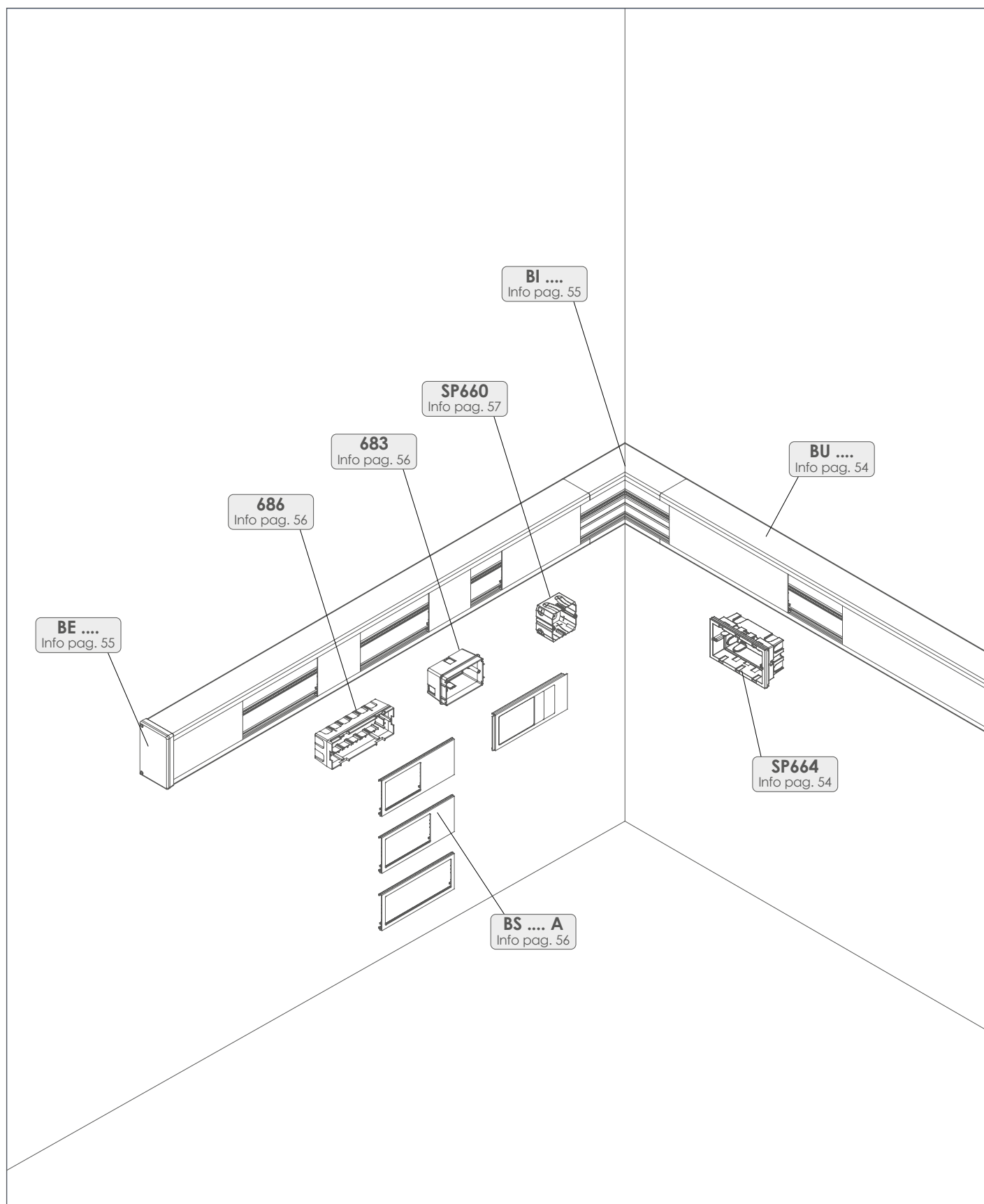

Colori disponibili: (A) Alluminio anodizzato, (VN) Alluminio nero, (A3) Alluminio bianco
Available colours: (A) Anodized aluminium, (VN) Black aluminium, (A3) White aluminium

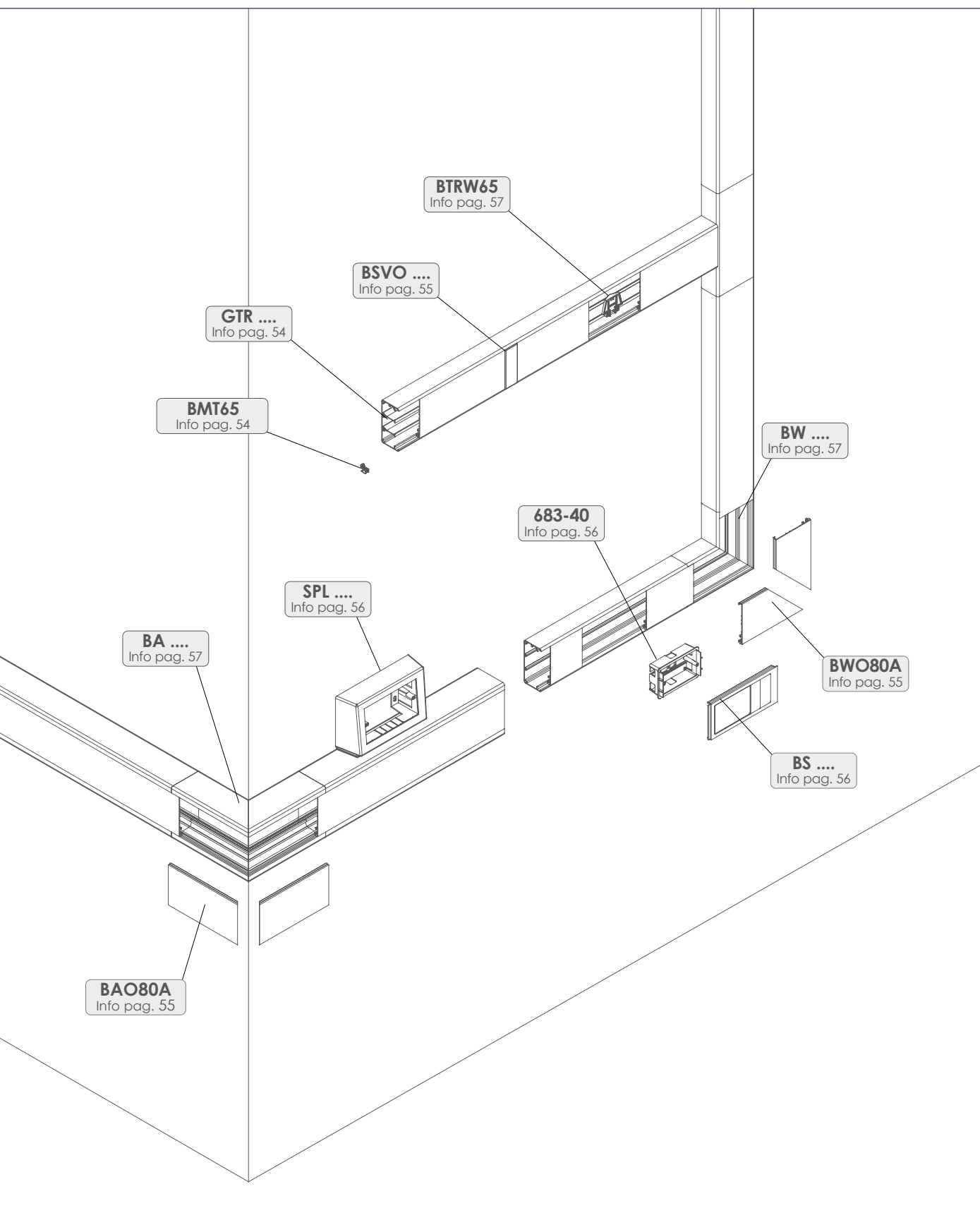

Canali di distribuzione in ALLUMINIO Aluminium parapet trunking system

						
Profilo Profile	Dimensioni B x H Dimensions B x H	Scomparti Section	Canale Trunking	Coperchio in ALLUMINIO Aluminium cover	Coperchio in Pvc Pvc cover	Separatore in Pvc Pvc separator
	90x40 mm	3	BU40908A BU40908VN BU40908A3	BO80A BO80VN BO80A3	BO80.2 BO80.3	GTR40-1
	105x65 mm	3	BU651058A BU651058VN BU651058A3	BO80A BO80VN BO80A3	BO80.2 BO80.3	GTR60-1
	130x65 mm	3	BU651308A	BO80A BO80VN BO80A3	BO80.2 BO80.3	GTR60-1
	180x65 mm	6	BU651808-2A	BO80A BO80VN BO80A3	BO80.2 BO80.3	GTR60-1

Dati tecnici dei canali Trunking data table

Articolo Item	Scomparti Sections	Dimensioni Dimensions	Sezioni scomparti mm ² Compartments cross section mm ²							Sezione totale senza divisori Total section without separator
			1	2	3	4	5	6	TOT	
BU40908	3	90 x 40 mm	1.000	780	1.000				2.780	2.955 mm ²
BU651058	3	105 x 65 mm	2.265	1.260	2.265				5.790	6.035 mm ²
BU651308	3	130 x 65 mm	3.050	1.260	3.050				7.360	7.680 mm ²
BU651808-2	6 (3X2)	180 x 65 mm	1.845	1.240	1.845	1.845	1.240	1.845	9.860	10.160 mm ²

Articolo Item	Descrizione Description	
BMT65	Morsetto di terra Ground clamp	

Articolo Item	Descrizione Description	
BSZ65	Spine di allineamento per canale Trunking alignment pins	

Colori disponibili: (A) Alluminio anodizzato, (VN) Alluminio nero, (A3) Alluminio bianco
Available colours: (A) Anodized aluminium, (VN) Black aluminium, (A3) White aluminium

						
Angolo interno Internal angle	Angolo esterno External angle	Coperchio angolo esterno Cover external angle	Curva piana Flat angle	Coperchio curva piana Cover flat angle	Coprigiunzione Cover joint	Terminale End piece
BI908A BI908VN BI908A3	BA908A BA908VN BA908A3	BAO80A BAO80VN BAO80A3	BW908A BW908VN BW908A3	BWO80A BWO80VN BWO80A3	BSVO80.AL BSVO80.2 BSVO80.3	BE908.AL BE908.2 BE908.3
BI1058A BI1058VN BI1058A3	BA1058A BA1058VN BA1058A3	BAO80A BAO80VN BAO80A3	BW1058A BW1058VN BW1058A3	BWO80A BWO80VN BWO80A3	BSVO80.AL BSVO80.2 BSVO80.3	BE1058.AL BE1058.2 BE1058.3
BI1308A	BA1308A	BAO80A	BW1308A	BWO80A	BSVO80.AL BSVO80.2 BSVO80.3	BE1308.AL BE1308.2 BE1308.3
BI1808A	BA1808A	BAO80A	BW1808A	BWO80A	BSVO80.AL BSVO80.2 BSVO80.3	BE1808.AL BE1808.2 BE1808.3



Supporto per apparecchi modulari
Support for modular switches

Articolo Item	A mm	B mm	C mm
605-4	50	7,5	35

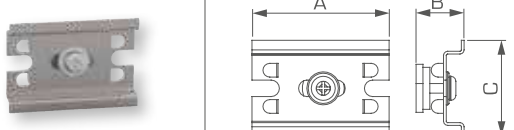

Traversa reggicavo
Cable retainer

Articolo Item	Descrizione Description	
BTRW65	Aggancio su separatore Fixing on separator	

Scatola porta apparecchi 3 moduli
Socket box 3 modules

Articolo Item	Per canali For trunkings	A mm	B mm	C mm	D mm
683-40	H 40 mm	103	36	68	83,5
683	H 65 mm	103	50	68	83,5

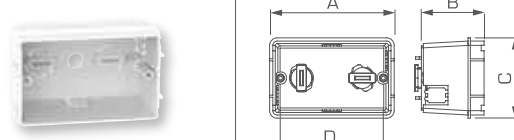

Mostrina in PLASTICA per scatole 683 e 686
Plastic frame for boxes 683 and 686

Articolo Item	A mm	B mm	C mm	D mm
BS80-53.AL	210	80	83,5 - 108,5 - 100	64
BS80-53.2	210	80	83,5 - 108,5 - 100	64
BS80-53.3	210	80	83,5 - 108,5 - 100	64

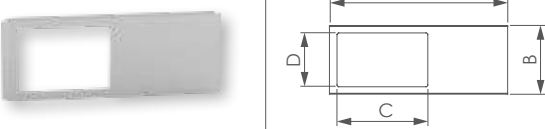

Scatola porta apparecchi 4-3 moduli
Socket box 4-3 modules italian standard

Articolo Item	Interasse D Centres D	A mm	B mm	C mm
SPL504.AL	108,5 (83,5)	175	55	110

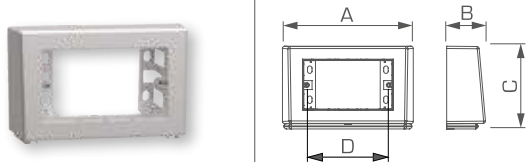

Mostrina per apparecchi modulari in alluminio
Frame for modular switches in aluminium

Articolo Item	A mm	B mm	C mm	D mm
BS80-04A	210	80	45	35
BS80-04.2	210	80	45	35
BS80-04.3	210	80	45	35

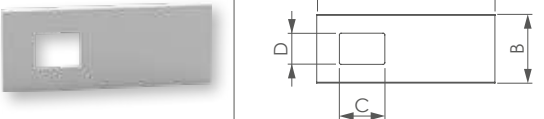

Scatola porta apparecchi 3-4-7 moduli
Socket box 3-4-7 modules

Articolo Item	A mm	B mm	C mm	D mm	E mm	F mm
686	175	50	68	83,5	108,5	100

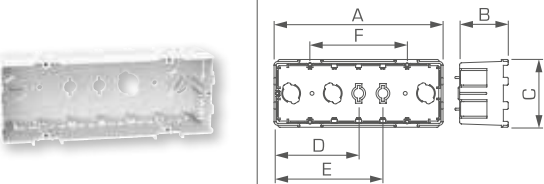

Mostrine in ALLUMINIO per scatole 683 e 686
Aluminium frames for boxes 683 and 686

Articolo Item	Moduli Module	A mm	B mm	C mm	D mm
BS80-53A	3	210	80	83,5	64
BS80-54A	4	210	80	108,5	64
BS80-56A	7	210	80	100	64

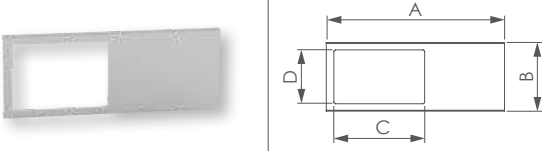

Scatola porta apparecchi 7 moduli
Socket box 7 modules italian standard

Articolo Item	Interasse Centres	A mm	B mm	C mm
SPL506.AL	100x60 mm	235	55	110

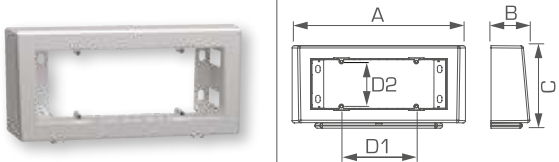

Scatola porta apparecchi per canali H65 mm Socket box for trunkings H65 mm

Articolo Item	Moduli e standard Modules and standard	A mm	B mm	C mm	D mm
SP660	2 italiani - italian 1 tedesco - german 1 inglese - english	70	55	80	60
SP664	4 italiani - italian	132	55	80	108,5
SP664E	2 inglesi - english	144	55	80	120,6
SP667	7 italiani - italian	184	55	80	100

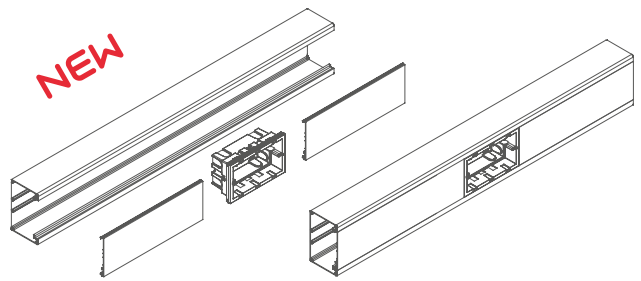

NUOVE scatole porta apparecchi con aggancio a scatto sul bordo del canale. Questo sistema permette di non usare le mostrine accostando il coperchio alla scatola.

VANTAGGI:

1. Un risultato estetico migliore senza interruzioni del coperchio
2. Una flessibilità maggiore nel posizionamento della scatola
3. Un risparmio economico in quanto non si usano le mostrine

NEW socket boxes with snap hook on the edge of the trunking. This system allows you not to use the frames holding the cover to the box.

ADVANTAGES:

1. A better aesthetic result without interruptions of the cover
2. Greater flexibility in the positioning of the box
3. An economic saving as the frames are not used

Curva piana preformata in alluminio Preformed flat angle of aluminium

Articolo Item	A mm	B mm	C mm	D mm
BW908A	163	163	40	90
BW1058A	210	210	65	105
BW1308A	225	225	65	130
BW1808A	250	250	65	180

Angolo interno preformato in alluminio Preformed internal angle of aluminium

Articolo Item	A mm	B mm	C mm	D mm
BI908A	110	110	40	90
BI1058A	185	185	65	105
BI1308A	185	185	65	130
BI1808A	185	185	65	180

Angolo esterno preformato in alluminio Preformed external angle of aluminium

Articolo Item	A mm	B mm	C mm	D mm
BA908A	69	69	40	90
BA1058A	119	119	65	105
BA1308A	119	119	65	130
BA1808A	119	119	65	180

Derivazione a T preformata in alluminio Preformed T-Joint of aluminium

Articolo Item	A mm	B mm	C mm	D mm	E mm
BT908A	195	40	90	80	12
BT1058A	245	65	105	80	28
BT1308A	245	65	130	80	28
BT1808A	245	65	180	135	40

WING *Design*

Sistema di canali a battiscopa e cornice

Skirting and wall trunking system





Caratteristiche Tecniche

- Canale in PVC ed accessori in ABS
- Canale lunghezza standard 2 metri
- Apertura coperchio con attrezzo
- Resistenza all'urto IK08 (5J)
- Grado di protezione IP40
- Tensione nominale 750V
- Temperatura di utilizzo -15°C +60°C

Technical Features

- PVC Trunkings and ABS accessories
- Trunking standard length 2 meters
- Cover disassembling with tool
- Mechanical protection IK08 (5J)
- Protection degree IP40
- Rated voltage 750V
- Working temperature -15°C +60°C

Riferimenti a Norme

- Conforme alla norma CEI EN 50085-2-1
- Conforme alla Direttiva RoHS 2015/863/EU
- Conforme alla Direttiva B.T. 2009/95/CE

Norms Reference

- Complies with standard CEI EN 50085-2-1
- Compliant with RoHS Directive 2015/863/EU
- Compliant with the Low Voltage Directive 2009/95/CE

Marchi e Certificazioni

- Marchio IMQ riferimento n° EE889 (Battiscopa), n° EE890 (Cornice)
- Marcatura CE

Marks and Certifications

- IMQ mark reference n° EE889 (Skirting) n° EE890 (Wall)
- CE marking

Colori disponibili

- Bianco RAL9010, Nero RAL7021

Available colours

- White RAL9010, Black RAL7021

Decorazioni disponibili

- Decorato Alluminio, Decorato Wengè, Decorato Frassino, Decorato Ciliegio

Available Decoration

- Aluminium trimming, Wengè trimming, Ash trimming, Cherry trimming

Decorazioni Decorations

Design



Arnocanali ha sempre tratto grande soddisfazione dall'esaudire le esigenze dei propri clienti, ma ha scoperto col tempo che la vera forza per affrontare il futuro e gli stimoli giusti per innovarsi derivano dal superare le loro aspettative, facendo di questo il difficile ma costante obiettivo di tutta l'organizzazione.

Arnocanali propone innovative finiture per la linea Wing, che viene proposta in 4 differenti decorazioni.

Il film acrilico che viene applicato sui profili viene prodotto con una goffatura visibile e percettibile al tatto e con un sistema fotografico per riprodurre fedelmente le venature al fine di rendere il prodotto molto simile al legno. Il film ha uno spessore di 200 micron è resistente agli urti, agli agenti atmosferici ed ai raggi ultravioletti.

Wing Design è un prodotto innovativo e creativo che si differenzia dai tradizionali battiscopa presenti sul mercato. Apprezzato da molti professionisti per la qualità e gli abbinamenti integrabili con i migliori materiali da costruzione e rifinitura, sia nel settore domestico che terziario.

Arnocanali has always drawn great satisfaction from fulfilling the needs of its customers, but has discovered over time that the real strength to face the future and the right incentives to innovate, derive from exceeding their expectations, making this the difficult but constant goal of the whole organization.

Arnocanali offers innovative finishes for the Wing line, which is offered in 4 different decorations.

The acrylic film that is applied on the profiles is produced with a visible and perceptible embossing to the touch and with a photographic system to faithfully reproduce the grain in order to make the product very similar to wood. The film has a thickness of 200 microns and is resistant to shocks, atmospheric agents and ultraviolet rays.

Wing Design is an innovative and creative product, which differs from traditional skirting boards on the market. Appreciated by many professionals for the quality and combinations that can be integrated with the best construction and finishing materials both in the domestic and tertiary sector.

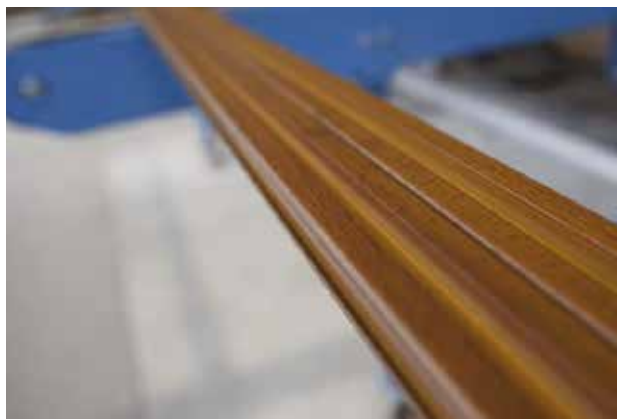

.AL Alluminio
.AL Aluminium



.FR Frassino
.FR Ash



.CL Ciliegio
.CL Cherry



.WG Wengè
.WG Wengè

Esempio applicativo accessori Example of accessories application

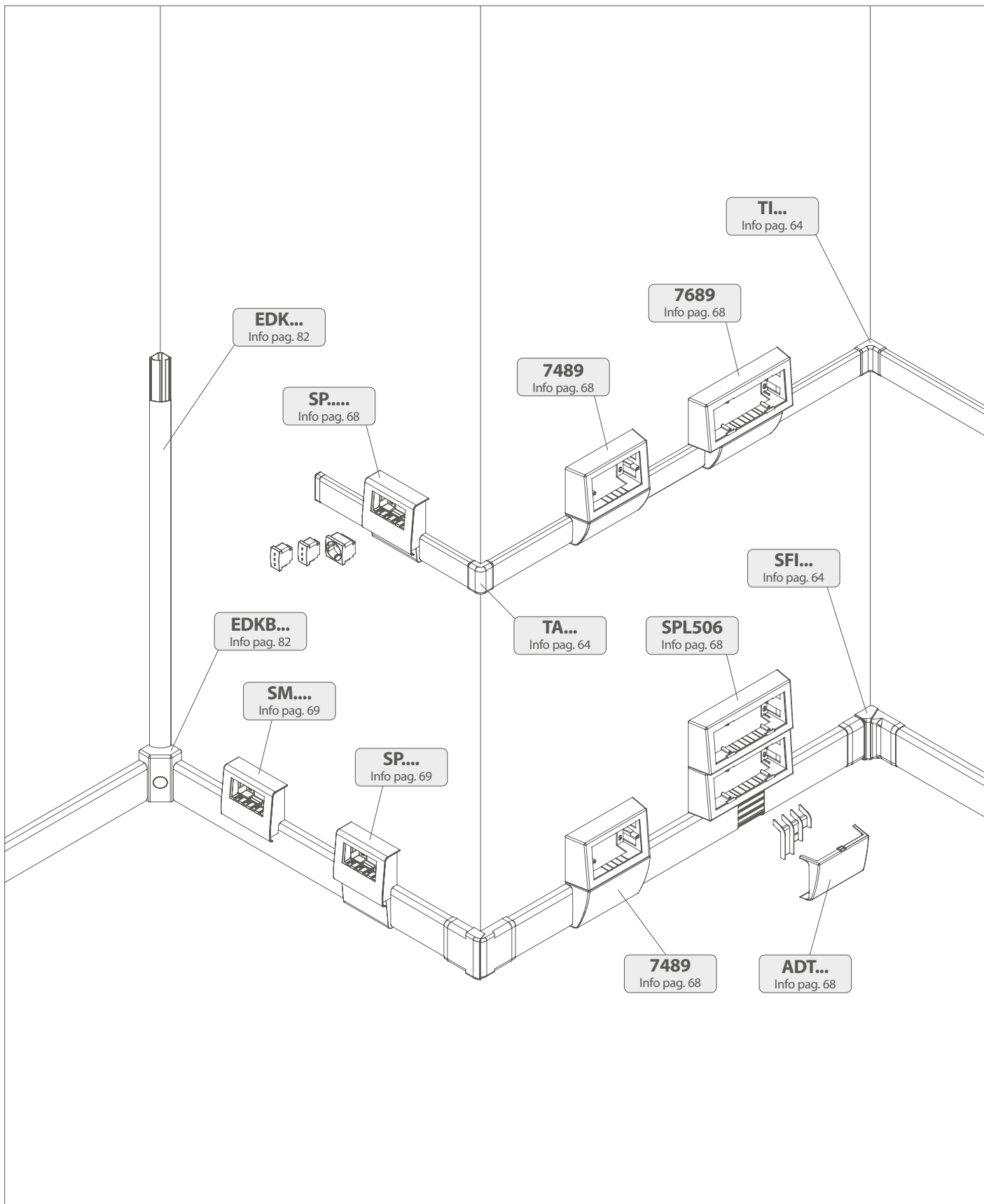

Colori disponibili: (.3) Bianco RAL9010, (.2) Nero RAL7021







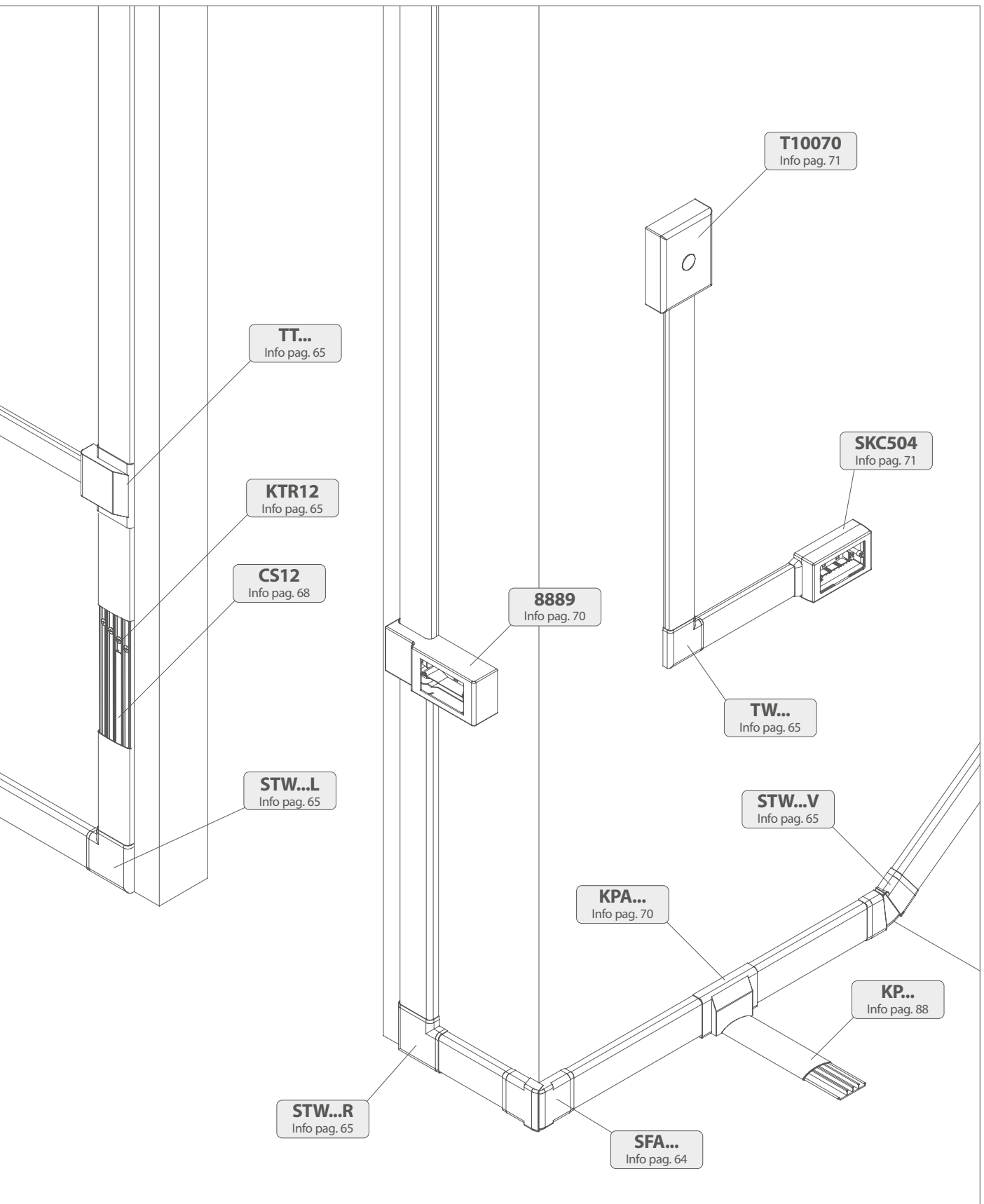

Decorazioni disponibili: (.AL) Alluminio, (.WG) Wengè, (.FR) Frassino, (.CL) Ciliegio

Available colours: (.3) White RAL9010, (.2) Black RAL7021

Available decoration: (.AL) Aluminium, (.WG) Wengè, (.FR) Ash, (.CL) Cherry

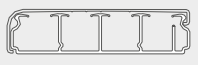

Canali BATTISCOPA SKIRTING trunkings

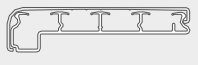







							
Profilo Profile	Dimensioni Dimensions	Scomparti Section	Base canale Trunking base	Coperchio canale Trunking cover	Angolo interno variabile 65°/135° Internal variable angle 65°/135°	Angolo esterno variabile 70°/140° External variable angle 70°/140°	Copri giunzione Cover joint
	70x20 mm	3	K72	B72.3 B72.2	SFI70V.3 SFI70V.2	SFA70V.3 SFA70V.2	TK70.3 TK70.2
	100x25 mm	4	K103	B103.3 B103.2	SFI100V.3 SFI100V.2	SFA100V.3 SFA100V.2	TK100.3 TK100.2
	100x25 mm	5	K104				
	100x25 mm	4	KL103				





Canali CORNICE WALL trunkings

							
Profilo Profile	Dimensioni Dimensions	Scomparti Section	Base canale Trunking base	Coperchio canale Trunking cover	Angolo interno variabile 65°/135° Internal variable angle 65°/135°	Angolo esterno variabile 70°/140° External variable angle 70°/140°	Copri giunzione Cover joint
	70x20 mm	3	K72	C72.3 C72.2	TI70V.3 TI70V.2	TA70V.3 TA70V.2	TK70.3 TK70.2
	100x25 mm	4	K103	C103.3 C103.2	TI100V.3 TI100V.2	TA100V.3 TA100V.2	TK100.3 TK100.2
	100x25 mm	5	K104				

Colori disponibili: (.3) Bianco RAL9010, (.2) Nero RAL7021

Available colours: (.3) White RAL9010, (.2) Black RAL7021

							
Terminale sinistro End piece left	Terminale destro End piece right	Curva piana variabile sx Variable flat angle left	Curva piana variabile dx Variable flat angle right	Curva piana sinistra Flat angle left	Curva piana destra Flat angle right	Derivazione Derivation	Traversine e giunti Cable clamps and joints
SFE70L.3 SFE70L.2	SFE70R.3 SFE70R.2	STW70VL.3 STW70VL.2	STW70VR.3 STW70VR.2	STW70L.3 STW70L.2	STW70R.3 STW70R.2	TT70.3 TT70.2	KTR12
SFE100L.3 SFE100L.2	SFE100R.3 SFE100R.2	STW100VL.3 STW100VL.2	STW100VR.3 STW100VR.2	-	-	TT100.3 TT100.2	

				
Terminale Terminal	Curva piana variabile Variable flat angle	Curva piana Flat angle	Derivazione Derivation	Traversine e giunti Cable clamps and joints
TE70L.3 TE70L.2	TW70V.3 TW70V.2	TW70.3 TW70.2	TT70.3 TT70.2	KTR12
TE100L.3 TE100L.2	TW100V.3 TW100V.2	TW100.3 TW100.2	TT100.3 TT100.2	

Canali BATTISCOPA decorati
Decorated SKIRTING trunkings

Design



							
Profilo Profile	Dimensioni Dimensions	Scomparti Section	Base canale Trunking base	Coperchio canale Trunking cover	Angolo interno variabile Internal variable angle	Angolo esterno variabile External variable angle	Copri giunzione Cover joint
	70x20 mm	3	K72	B72.AL B72.WG B72.FR B72.CL	SF170V.AL SF170V.WG SF170V.FR SF170V.CL	SFA70V.AL SFA70V.WG SFA70V.FR SFA70V.CL	TK70.AL TK70.WG TK70.FR TK70.CL
	100x25 mm	4	K103	B103.AL B103.WG B103.FR B103.CL	SF1100V.AL SF1100V.WG SF1100V.FR SF1100V.CL	SFA100V.AL SFA100V.WG SFA100V.FR SFA100V.CL	TK100.AL TK100.WG TK100.FR TK100.CL
	100x25 mm	5	K104				
	100x25 mm	4	KL103				

Canali CORNICE decorati
Decorated WALL trunkings

Design

							
Profilo Profile	Dimensioni Dimensions	Scomparti Section	Base canale Trunking base	Coperchio canale Trunking cover	Angolo interno variabile Internal variable angle	Angolo esterno variabile External variable angle	Copri giunzione Cover joint
	70x20 mm	3	K72	C72.AL	TI70V.AL	TA70V.AL	TK70.AL
	100x25 mm	4	K103	C103.AL	TI100V.AL	TA100V.AL	TK100.AL
	100x25 mm	5	K104				

Decorazioni disponibili: (.AL) Alluminio, (.WG) Wengè, (.FR) Frassino, (.CL) Ciliegio
Available decoration: (.AL) Aluminium, (.WG) Wengè, (.FR) Ash, (.CL) Cherry

						
Terminale sinistro End piece left	Terminale destro End piece right	Curva piana Flat angle	Derivazione Derivation	Derivazione canale KP KP trunking derivation	Scatola di derivazione Derivation box	Traversine e giunti Cable clamps and joints
SFE70L.AL SFE70L.WG SFE70L.FR SFE70L.CL	SFE70R.AL SFE70R.WG SFE70R.FR SFE70R.CL	TW70.AL TW70.WG TW70.FR TW70.CL	TT70.AL SFT70.WG SFT70.FR SFT70.CL	KPA70.AL KPA70.WG KPA70.FR KPA70.CL	S10070.AL S10070.WG S10070.FR S10070.CL	KTR12
SFE100L.AL SFE100L.WG SFE100L.FR SFE100L.CL	SFE100R.AL SFE100R.WG SFE100R.FR SFE100R.CL	TW100.AL TW100.WG TW100.FR TW100.CL	SFT100.AL SFT100.WG SFT100.FR SFT100.CL	KPA100.AL KPA100.WG KPA100.FR KPA100.CL		

					
Terminale End piece	Curva piana Flat angle	Derivazione Derivation	Derivazione canale KP KP trunking derivation	Scatola di derivazione Derivation box	Traversine e giunti Cable clamps and joints
TE70L.AL	TW70.AL	TT70.AL	KPA70.AL	T10070.AL	KTR12
TE100L.AL	TW100.AL		KPA100.AL		

Tribox

Scatola 4-3 moduli standard italiano
Socket box 4-3 modules italian standard

Articolo Item	Per canali For trunkings	Colori Colour	A mm	B mm	C mm
7489	H 70 mm	.2, .3,	175	55	182
10489	H 100 mm	.AL, .WG, .FR, .CL	175	55	212

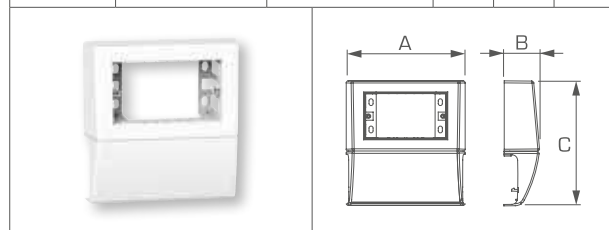

Scatola 7 moduli standard italiano
Socket box 7 modules italian standard

Articolo Item	Per canali For trunkings	Colori Colour	A mm	B mm	C mm
7689	H 70 mm	.2, .3,	235	55	182
10689	H 100 mm	.AL, .WG, .FR, .CL	235	55	212

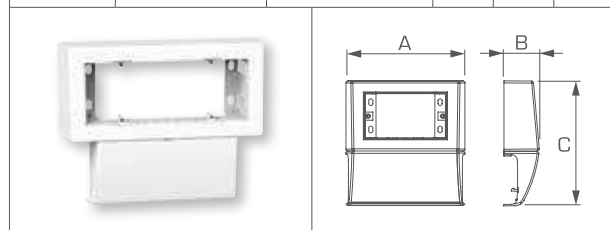

Scatola 4-3 moduli standard italiano
Socket box 4-3 modules italian standard

Articolo Item	Colori Colour	A mm	B mm	C mm
SPL504	.2, .3, .AL, .WG, .FR, .CL	175	55	110

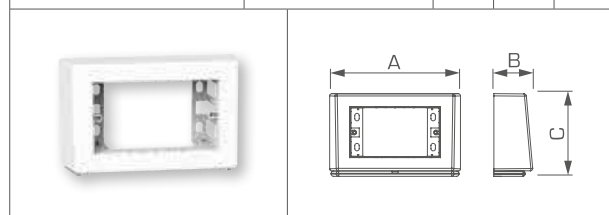

Scatola 7 moduli standard italiano
Socket box 7 modules italian standard

Articolo Item	Colori Colour	A mm	B mm	C mm
SPL506	.2, .3, .AL, .WG, .FR, .CL	235	55	110

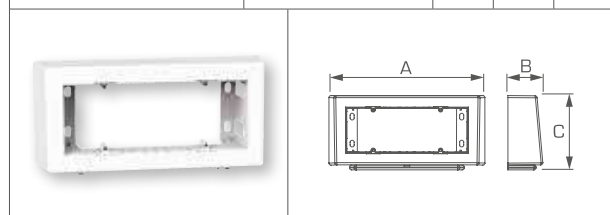

Scatola 2 moduli standard Tedesco
Socket box 2 modules German standard

Articolo Item	Colori Colour	A mm	B mm	C mm
SPL502	.3	175	55	110

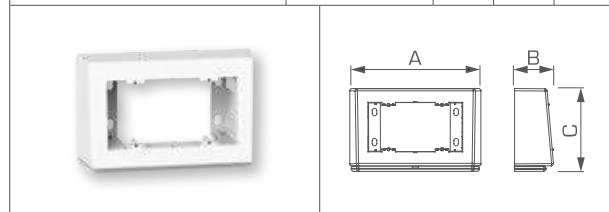

Copriscomparto per K72, K103, K104, KL103
Compartment cover for K72, K103, K104, KL103

Articolo Item	Descrizione Description	A mm	B mm	C mm
CS12	Fornito in barre da 1 metro Supplied in 1 meter bars	175	55	111

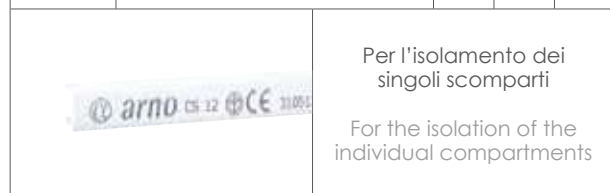

Raccordo tra scatole SPL e canali H70 mm
Fitting piece between SPL and trunkings H70 mm

Articolo Item	Per canali For trunkings	Colori Colour	A mm	B mm	C mm
ADT72	H 70 mm	.2, .3	175	55	80

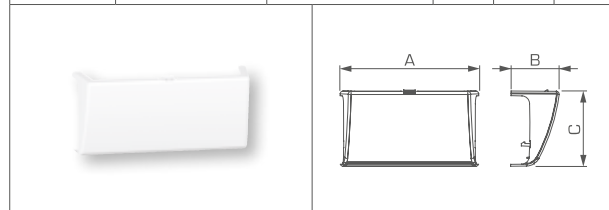

Raccordo tra scatole SPL e canali H100 mm
Fitting piece between SPL and trunkings H100 mm

Articolo Item	Per canali For trunkings	Colori Colour	A mm	B mm	C mm
ADT103	H 100 mm	.2, .3	175	55	111

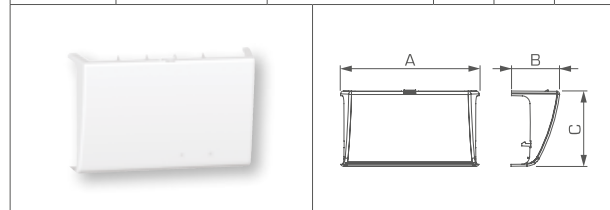

Mirror

Scatola porta apparecchi con montaggio moduli a scatto
Socket box for skirting and wall trunkings with modules click mounting

Articolo Item	Per canali For trunkings	Numero moduli e serie Modules number and serie	Colori Colours	A mm	B mm	C mm
SP074L	H 70 mm	Per 4 moduli BTicino Living Light versione SENZA specchi laterali For 4 modules BTicino Living Light version without side mirrors	.2, .3, .AL	130	50	185
SP104L	H 100 mm		.2, .3, .AL			
SM074L	H 70 mm	Per 4 moduli BTicino Living Light versione CON specchi laterali For 4 modules BTicino Living Light version with side mirrors	.2, .3, .AL, .WG, .FR, .CL			
SM104L	H 100 mm		.2, .3, .AL, .WG, .FR, .CL			
SP072-45	H 70 mm	Per 2 moduli 45x45 mm Standard Francese versione SENZA specchi laterali For 2 modules 45x45 mm French Standard version without side mirrors	.2, .3, .AL			
SP102-45	H 100 mm		.2, .3, .AL			
SM072-45	H 70 mm	Per 2 moduli 45x45 mm Standard Francese versione CON specchi laterali For 2 modules 45x45 mm French Standard version with side mirrors	.2, .3, .AL, .WG, .FR, .CL			
SM102-45	H 100 mm		.2, .3, .AL, .WG, .FR, .CL			



Le scatole porta apparecchi Mirror per canali battiscopa e cornice sono dotate di due specchietti laterali i quali creano un piacevole effetto visivo. Guardando le scatole di lato sembra che siano sospese sopra al canale, un sistema apprezzato da molti architetti per rompere la monotonia dei tradizionali impianti a parete. Adatte ad ambienti con elevata gradevolezza estetica.

The Mirror socket boxes for skirting and wall trunking of the Wing line are equipped with two side mirrors which create a pleasant visual effect. Looking at the boxes from the side it seems that they are suspended above the trunking, a system appreciated by many architects for breaking the monotony of traditional wall systems. Suitable for environments with high aesthetic appeal.



Giunzione tra 2 scatole Mirror Joint piece between 2 boxes

Articolo Item	Per canali For trunkings	Colori Colours	Quantità Quantity
SG70	H 70 mm	.3	1pz
SG100	H 100 mm		
			<p>Le scatole MIRROR possono essere unite, utilizzando il giunto SG</p> <p>The socket boxes MIRROR can be connected, using the joint piece SG</p>

Scatola 3 moduli orizzontale per canali verticali
3-module box for vertical trunkings

Articolo Item	Per canali For trunkings	Colori Colour	A mm	B mm	C mm
8889	H 70 mm	.2, .3, .AL	85	52	205
10889	H 100 mm		93	51	267

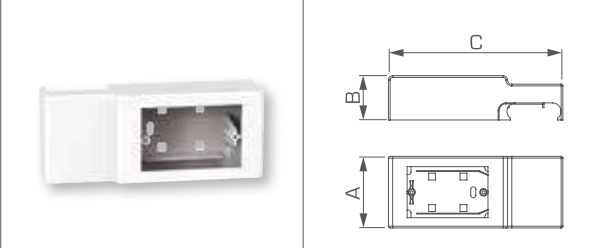

Scatola di derivazione con separatore
Derivation box with separator

Articolo Item	Colori Colour	A mm	B mm	C mm
6700S	.3	115	53	115
6701S		155	100	155

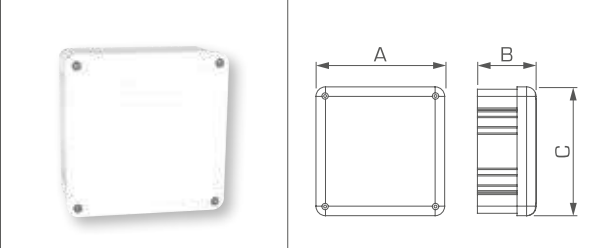

Scatola di derivazione con barre equipotenziali
Derivation box with equipotential bars

Articolo Item	Fori/dimensione barre Holes/bar dimension	A mm	B mm	C mm
6700BT12.3	12 x M5 12x2 mm	115	53	115
6701BT20.3	20 x M5 12x2 mm	155	80	155

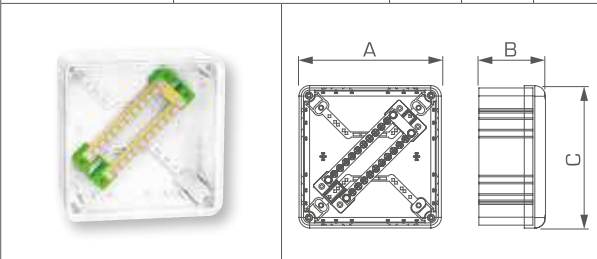

Per info tecniche vedi pag 245
For technical features see pag 245

Scatola di derivazione con morsettiera
Derivation box with equipotential terminal

Articolo Item	N. e dimensione fori N. Holes and dimension	A mm	B mm	C mm
6700TE14.3	4 x 16 mm ² 10 x 10 mm ²	115	53	115
6701TE28.3	4 x 16 mm ² 26 x 10 mm ²	155	80	155

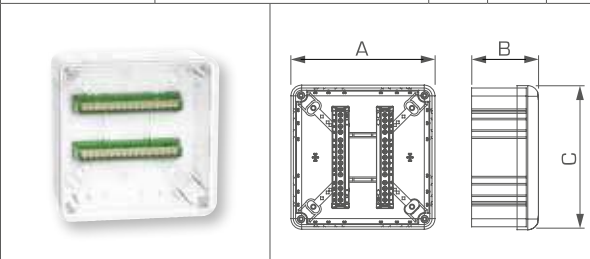

Le morsettiere possono essere aumentate vedi pag 245
The number of terminals can be increased see pag 245

Derivazione fra battiscopa e soprapavimento KP
Derivation between skirting and floor trunkings KP

Articolo Item	Colori Colour	A mm	B mm	C mm
KPA70	.2, .3, .AL, .WG, .FR, .CL,	120	30	72
KPA100		160	38	103

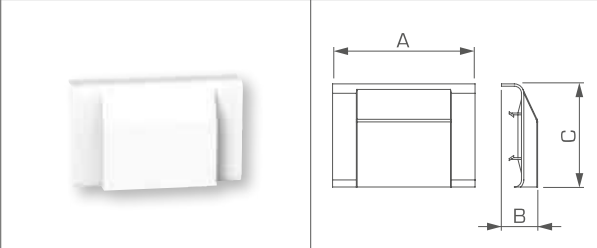

Derivazione fra canali battiscopa KB ed EDK
Derivation between skirting trunkings KB and EDK

Articolo Item	Per canali For channel	Colori Colour	A mm	B mm	C mm
EDKB70	H 70 mm	.3	90	82	58
EDKB100	H 100 mm		120	94	65

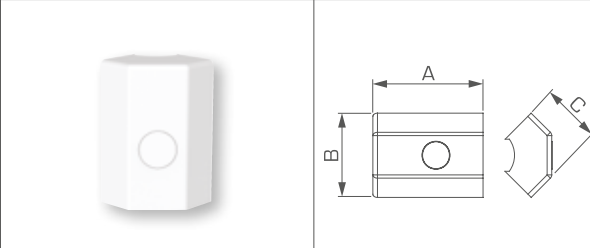

Scatola di derivazione per canali batticopa/cornice Derivation box for skirting and wall trunkings

Articolo Item	Per canali For trunkings	Colori Colour	A mm	B mm	C mm
S10070	KB - KC	.2, .3, .AL, .WG, .FR, .CL,	121	43	155
T10070	KC		121	43	160

Scatola porta apparecchi per canale cornice 70 mm Socket box for wall trunking 70 mm

Articolo Item	Moduli Modules	Colori Colour	A mm	B mm	C mm
SKC503	3	.2, .3, .AL	134	51	95
SKC504	4		159	51	95

Articolo Item	Dimensioni di foratura delle basi Punching dimensions of the bases						Sezione utile scomparti mm ² Compartments cross section mm ²		
	A	B	C	D	E	Ø F			
K72	A	126 mm					1	315 mm ²	
	B	20,5 mm					2	280 mm ²	
	C	20,5 mm					3	215 mm ²	
	D	4,5 mm							
	E	7,0 mm							
	Ø F	4,5 mm					TOT	810 mm ²	
K103	A	126 mm					1	445 mm ²	
	B	46,0 mm					2	405 mm ²	
	C	23,0 mm					3	405 mm ²	
	D	4,5 mm					4	320 mm ²	
	E	7,0 mm							
							TOT	1.575 mm ²	
K104	A	126 mm					1	355 mm ²	
	B	20,5 mm					2	333 mm ²	
	C	20,5 mm					3	325 mm ²	
	D	4,5 mm					4	333 mm ²	
	E	7,0 mm					5	225 mm ²	
	Ø F	4,5 mm					TOT	1.571 mm ²	
KL103	A	126 mm					1	345 mm ²	
	B	42,0 mm					2	200 mm ²	
	C	23,0 mm					3	200 mm ²	
	D	4,5 mm					4	155 mm ²	
	E	7,0 mm							
							TOT	900 mm ²	

Area per cavi
Area for cables

Traverse reggicavo
Cable clamps

Area da mantenere vuota
Area to maintain empty

DOUBLE

Sistema di canali
per applicazioni a parete e sopra-battiscopa

Trunking system
for wall and over-skirting installation





Caratteristiche Tecniche

- Canale in PVC ed accessori in ABS
- Canale lunghezza standard 2 metri
- Apertura coperchio con attrezzo
- Resistenza all'urto IK 08 (5J)
- Grado di protezione IP40
- Tensione nominale 750V
- Temperatura di utilizzo -15°C +60°C

Technical Features

- Trunking of PVC and accessories of ABS
- Trunking standard length 2 meters
- Cover disassembling with tool
- Mechanical protection IK 08 (5J)
- Protection degree IP40
- Rated voltage 750V
- Working temperature -15°C +60°C

Riferimenti a Norme

- La linea è conforme alla norma CEI EN 50085-2-1
- La linea è conforme alla Direttiva Rohs 2 2015/863/EU
- La linea è conforme alla Direttiva B.T. 2009/95/CE

Norms Reference

- The system complied to CEI EN 50085-2-1
- The system complied to Rohs 2 2015/863/EU
- The system complied to L.V.D. 2009/95/CE

Marchi e Certificazioni

- Marchio IMQ riferimento n° EE892
- Marcatura CE

Marks and Certifications

- IMQ Mark reference n° EE892
- CE Marking

Colori disponibili

- Bianco RAL9010

Available colours

- White RAL9010

Esempio applicativo accessori Example of accessories application

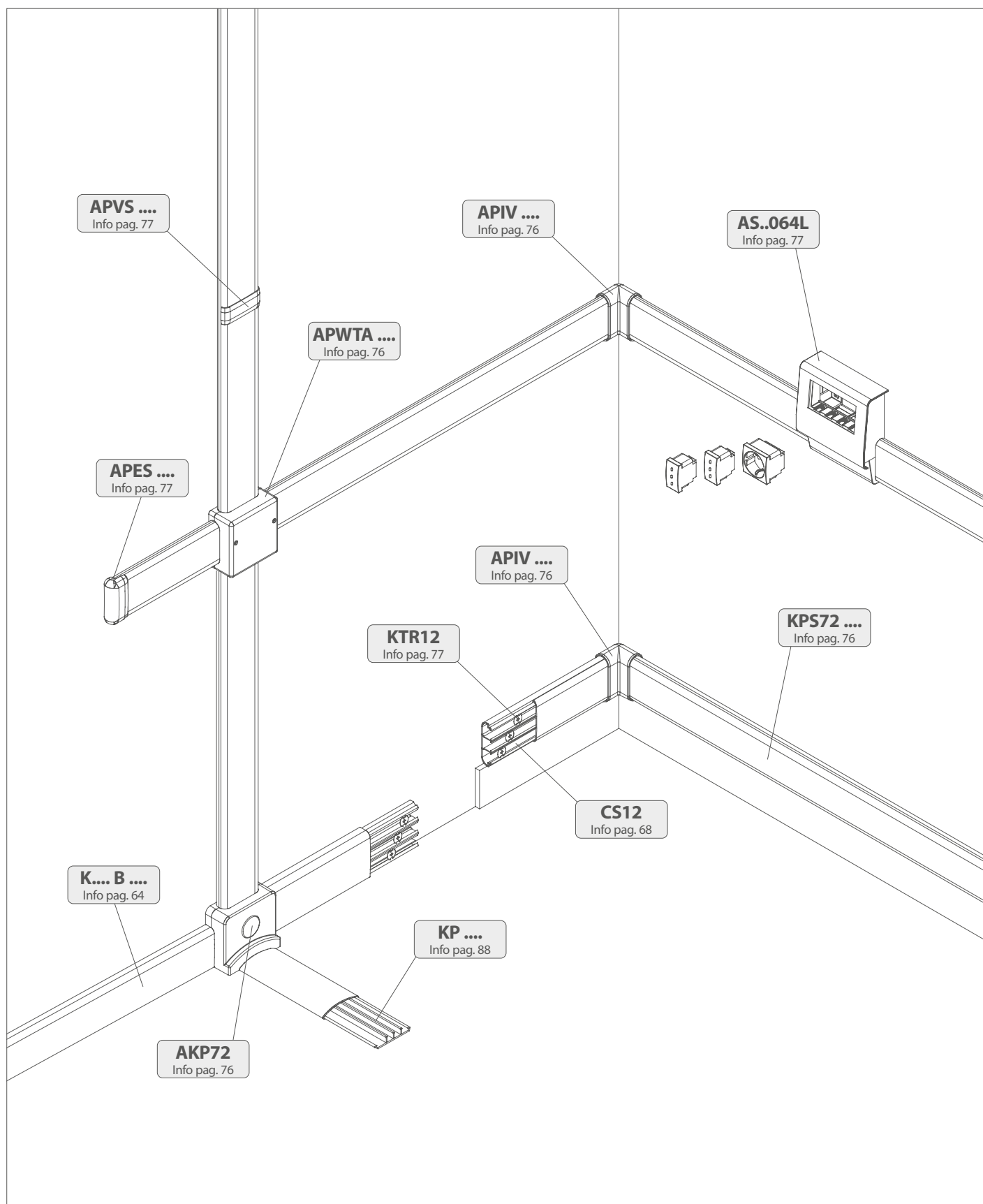

Colori disponibili: (.3) Bianco RAL9010
Available colours: (.3) White RAL9010

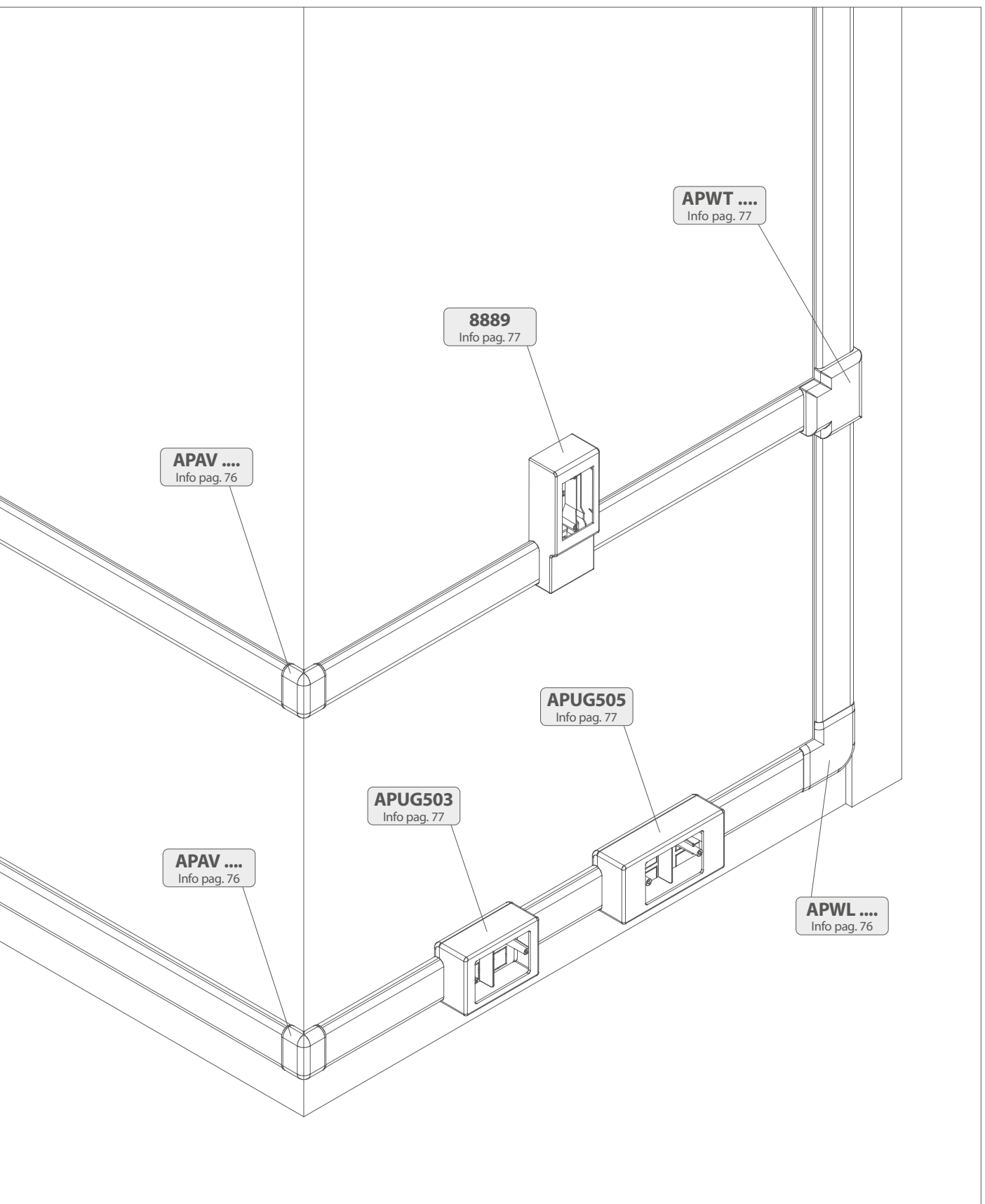

DOUBLE canali per uso a parete e soffitto
DOUBLE trunkings for wall and ceiling installations

						
Profilo Profile	Dimensioni Dimensions	Scomparti Section	Canale Trunking	Angolo interno variabile Internal variable angle	Angolo esterno variabile External variable angle	Curva piana Flat angle
	65x20 mm	3	KPS72.3	APIV.3	APAV.3	APWL.3

Dati tecnici dei canali Trunking data table	Articolo Item	Scomparti Sections	Dimensioni Dimensions	Sezioni scomparti mm ² Compartments cross section mm ²			
				1	2	3	TOT
				KPS72	3	65 x 20 mm	275

Scatola di derivazione
Derivation box

Articolo Item	Colori Colour	A mm	B mm	C mm
APWTA	.3	84	40	84



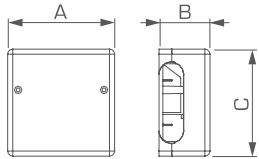

Derivazione con canali pavimento KP
Derivation with floor trunkings KP

Articolo Item	Colori Colour	A mm	B mm	C mm
AKP72	.3	91	41	79



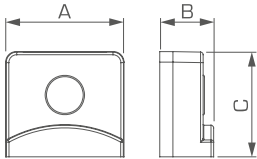

Derivazione con canali angolari EDK
Derivation with corner trunkings EDK

Articolo Item	Colori Colour	A mm	B mm	C mm
EDKD50	.3	115	42	60



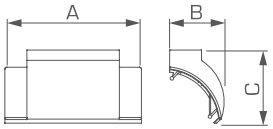

Scatola di derivazione con separatore
Derivation box with separator

Articolo Item	Colori Colour	A mm	B mm	C mm
6700S	.3	115	53	115



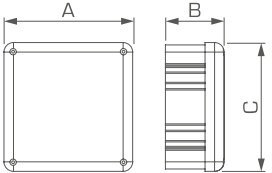

Colori disponibili: (.3) Bianco RAL9010

Available colours: (.3) White RAL9010

Derivazione Derivation	Curva sinistra fra KPS e battiscopa Left curve between KPS and skirting board	Curva destra fra KPS e battiscopa Right curve between KPS and skirting board	Coprigiunzione Cover joint	Terminale End piece	Traversine e giunti Cable clamps and joints
APWT.3	ASFWL.3	ASFWR.3	APVS.3	APES.3	KTR12

Scatola porta apparecchi 3 moduli Socket box 3 modules italian standard

Articolo Item	Colori Colour	A mm	B mm	C mm
APUG503	.3	159	51	93

Scatola porta apparecchi 4 (5) moduli Socket box 4 (5) modules italian standard

Articolo Item	Colori Colour	A mm	B mm	C mm
APUG505	.3	170	55	85

Scatola porta apparecchi 3 moduli Socket box 3 modules italian standard

Articolo Item	Colori Colour	A mm	B mm	C mm
8889	.3	85	52	205

Scatola autoportante 4 moduli BTicino Living Light Self-supporting box 4 BTicino Living Light modules

Articolo Item	Colori Colour	A mm	B mm	C mm
ASP064L	.3	235	55	110

CORNER

Sistema di canali
per applicazioni angolari

Trunking system
for corner installation





Caratteristiche Tecniche

- Canale in PVC ed accessori in ABS
- Canale lunghezza standard 2 metri
- Apertura coperchio con attrezzo
- Resistenza all'urto IK 08 (5J)
- Grado di protezione IP40
- Tensione nominale 750V
- Temperatura di utilizzo -15°C +60°C

Technical Features

- Trunking of PVC and accessories of ABS
- Trunking standard length 2 meters
- Cover disassembling with tool
- Mechanical protection IK 08 (5J)
- Protection degree IP40
- Rated voltage 750V
- Working temperature -15°C +60°C

Riferimenti a Norme

- La linea è conforme alla norma CEI EN 50085-2-1
- La linea è conforme alla Direttiva Rohs 2 2011/65/EU
- La linea è conforme alla Direttiva B.T. 2009/95/CE

Norms Reference

- The system complied to CEI EN 50085-2-1
- The system complied to Rohs 2 2011/65/EU
- The system complied to L.V.D. 2009/95/CE

Marchi e Certificazioni

- Marchio IMQ riferimento n° EE891
- Marcatura CE

Marks and Certifications

- IMQ Mark reference n° EE891
- CE Marking

Colori disponibili

- Bianco RAL9010

Available colours

- White RAL9010

Esempio applicativo accessori Example of accessories application

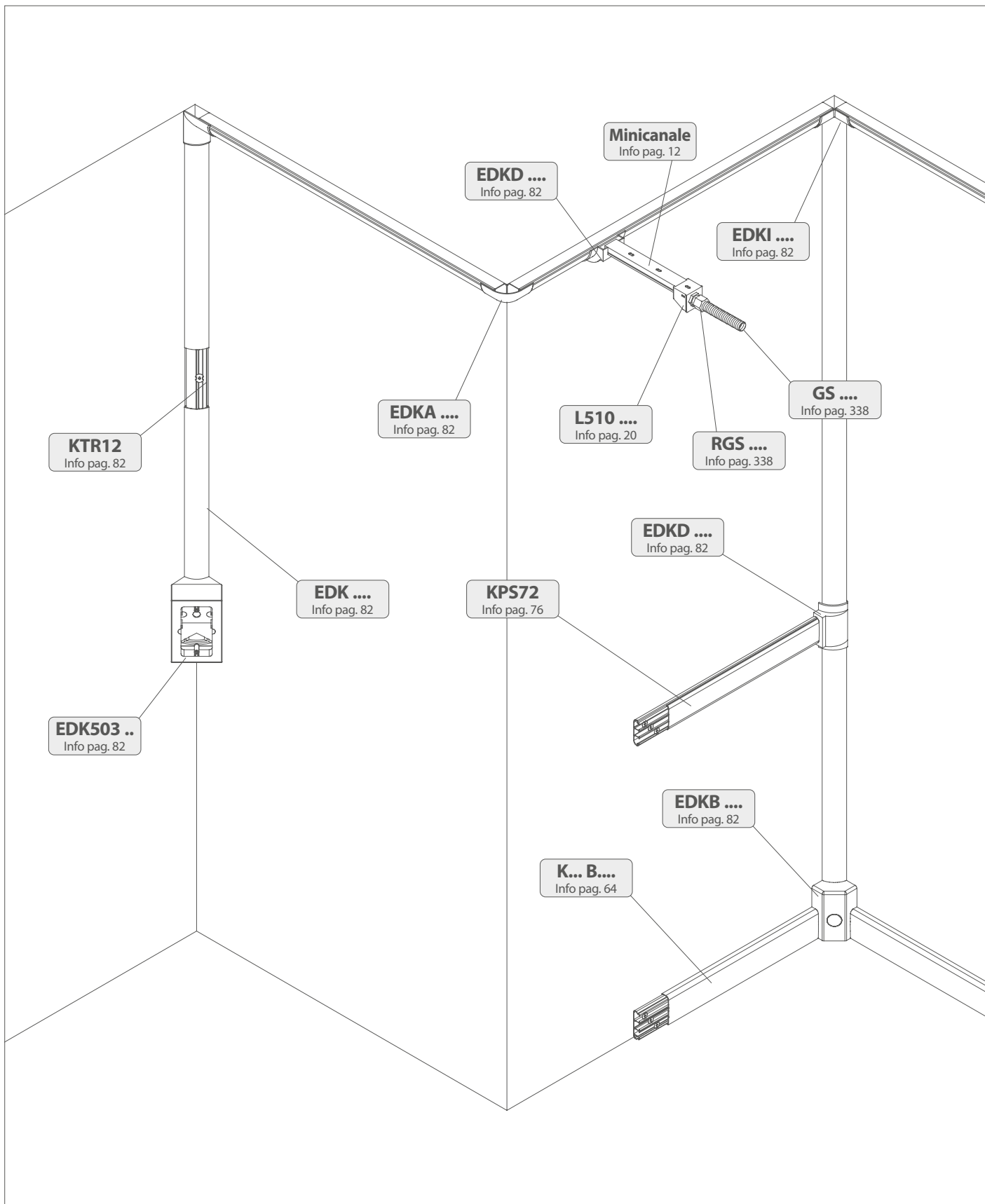

Colori disponibili: (.3) Bianco RAL9010

Available colours: (.3) White RAL9010

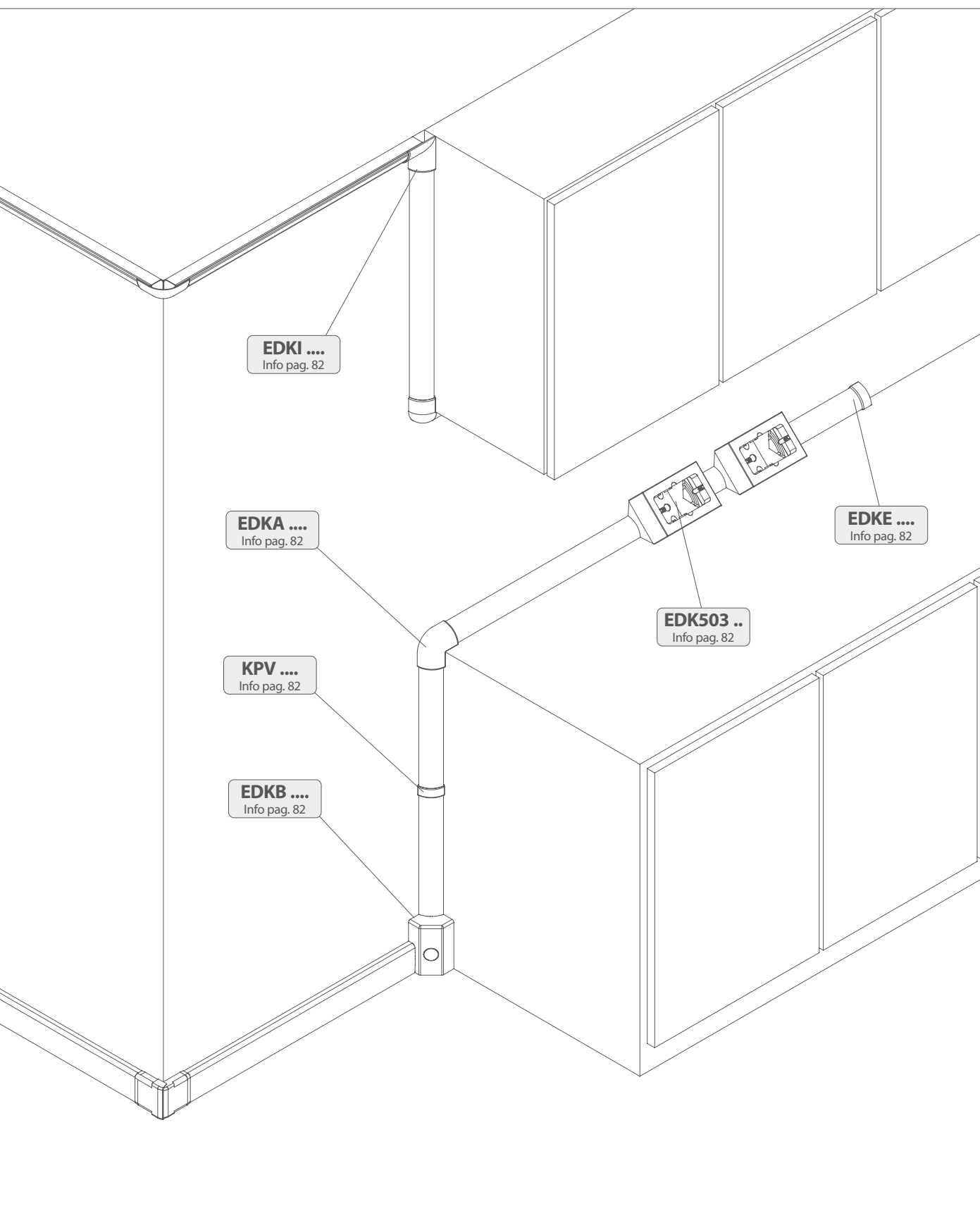

CORNER canali angolari CORNER corner trunkings

							
Profilo Profile	Dimensioni Dimensions	Scomparti Section	Canale Trunking	Angolo interno e derivazione Internal angle and derivation	Angolo esterno External angle	Copri giunzione Cover joint	Terminale e riduzione End piece and reducer
	30x30x35 mm	1	EDK3035.3	EDKI35.3	EDKA35.3	KPV35.3	EDKE35.3
	40x40x50 mm	1	EDK4050.3	EDKI50.3	EDKA50.3	KPV50.3	EDKE50.3

Derivazione con minicanali e canale KPS Derivation with minitrunkings and KPS trunking

Articolo Item	Derivazioni possibili Possible derivation	A mm	B mm	C mm
EDKD35.3	21x10, 18x18, 30x18	70	30	45
EDKD50.3	21x10, 18x18, 30x18 40x18, 50x18, KPS72	115	42	60

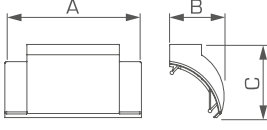
Derivazione fra canali battiscopa KB ed EDK Derivation between trunkings KB and EDK

Articolo Item	Moduli Modules	A mm	B mm	C mm
EDKB70.3	Altezza 70 mm	90	82	58
EDKB100.3	Altezza 100 mm	120	94	65

Scatola porta apparecchi angolare 3 moduli Socket box 3 modules italian standard

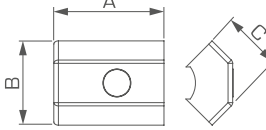
Articolo Item	Moduli Modules	A mm	B mm	C mm
EDK503.3	3	145	85	85

Traversine reggicavo Cable clamps

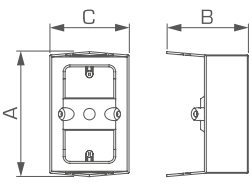
Articolo Item	
KTR12	Articolo composto da 64 traverse reggicavo Item includes 64 cable clamps



Dati tecnici dei canali Trunking data table

Articolo Item	Scomparti Sections	Dimensioni Dimensions	Sezioni scomparti mm ² Compartments section		A mm	ØB mm	Dimensione Dimension
			1	TOT			
EDK3035	1	30x30X35 mm	365 mm ²	140	204	4	
EDK4050	1	40x40X50 mm	845 mm ²	225	204	4	



CAMBER

Sistema di canali sopra-pavimento
per applicazioni a pavimento e parete

Over-floor trunking system
for floor and wall applications





Caratteristiche Tecniche

- Canale in PVC o alluminio ed accessori in ABS
- Apertura coperchio con attrezzo
- Resistenza all'urto IK 08 (5J)
- Grado di protezione IP40
- Tensione nominale 750V
- Temperatura di utilizzo -15°C +60°C

Technical Features

- Trunking of PVC or Aluminium and accessories of ABS
- Cover disassembling with tool
- Mechanical protection IK 08 (5J)
- Protection degree IP40
- Rated voltage 750V
- Working temperature -15°C +60°C

Riferimenti a Norme

- La linea è conforme alla norma CEI EN 50085-2-2 (Canale)
- La linea è conforme alla norma CEI EN 50085-2-4 (Torrette)
- La linea è conforme alla Direttiva Rohs 2 2015/863/EU
- La linea è conforme alla Direttiva B.T. 2009/95/CE

Norms Reference

- The system complied to CEI EN 50085-2-2 (Trunking)
- The system complied to CEI EN 50085-2-4 (Turrets)
- The system complied to Rohs 2 2015/863/EU
- The system complied to L.V.D. 2009/95/CE

Marchi e Certificazioni

- Marchio IMQ riferimento n° CA02.02902 (Canale)
- Marchio IMQ riferimento n° CA02.01017 (Torrette)
- Marcatura CE

Marks and Certifications

- Mark IMQ reference n° CA02.02902 (Trunking)
- Mark IMQ reference n° CA02.01017 (Turrets)
- CE Marking

Colori disponibili

- Grigio RAL7030, Bianco RAL9010, Nero RAL7021, Marrone RAL8014, verniciato Alluminio

Available colours

- Grey RAL7030, White RAL9010, Nero RAL7021, Brown RAL8014, Aluminium painted

Esempio applicativo accessori Example of accessories application

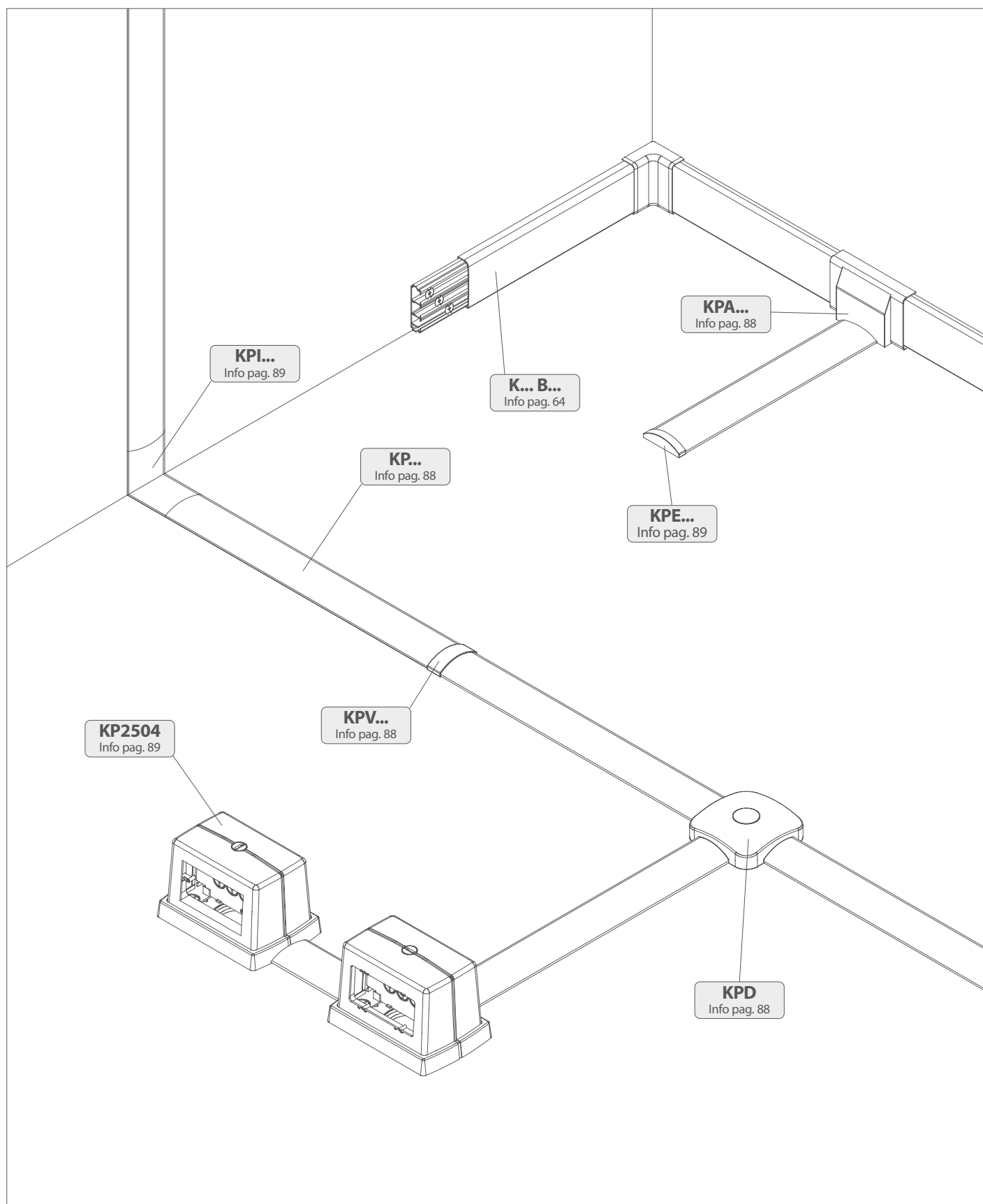

Colori disponibili: (.1) Grigio RAL7030, (.2) Nero RAL7021, (.3) Bianco RAL9010,
(.5) Marrone RAL8014, (.AL) Verniciato alluminio, (A) Alluminio anodizzato

Available colours: (.1) Grey RAL7030, (.2) Nero RAL7021, (.3) White RAL9010,
(.5) Brown RAL8014, (.AL) Aluminium painted, (A) Aluminium anodized

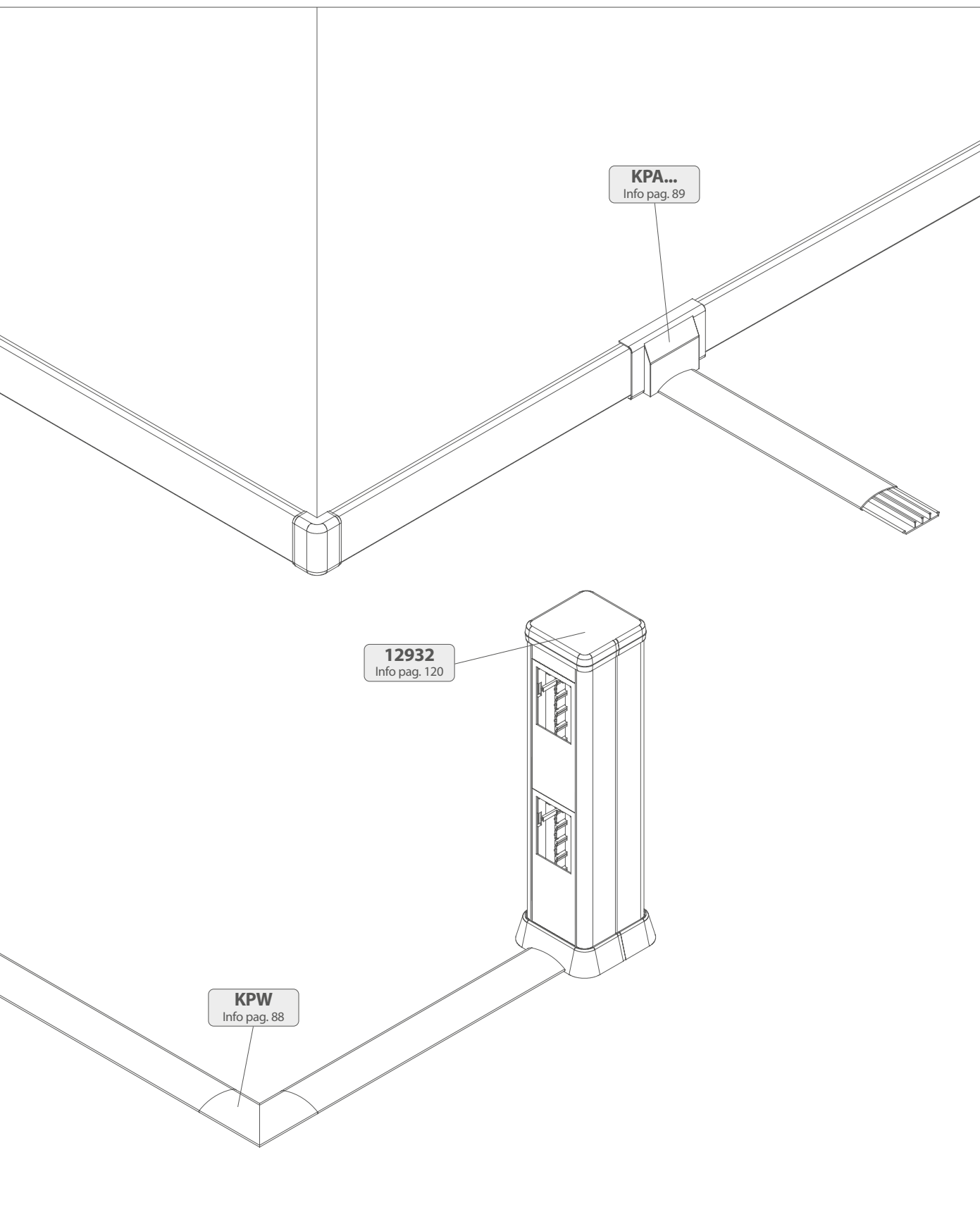

CAMBER canali porta cavi a pavimento e parete, in pvc e alluminio
CAMBER trunkings for floor and wall installation, pvc and aluminium

Profilo Profile	Dimensioni Dimensions	Scomparti Section	Canale Trunking	Curva piana Flat angle	Curva piana preformata Preformed flat angle	Coprigiunto Cover joint
	35x10 mm	2	KP1031.1 KP1031.3 KP1031.5		KPW1031.1 KPW1031.3	KPV35.1 KPV35.3
	50x12 mm	3	KP1252.1 KP1252.3 KP1252.5 KP1252A		KPW1252.1 KPW1252.3 KPW1252.5 KPW1252A	KPV50.1 KPV50.3 KPV50.AL
	75x18 mm	4	KP1873.1 KP1873.3 KP1873.5 KP1873.2 KP1873A	KPW1873.1 KPW1873.3 KPW1873.AL	KPW1873.2 KPW1873.5 KPW1873A	KPV75.1 KPV75.2 KPV75.3 KPV75.AL

Dati tecnici dei canali
Trunking data table

Articolo Item	Scomparti Sections	Dimensioni Dimensions	Sezioni scomparti mm ² Compartments cross section mm ²				
			1	2	3	4	TOT
KP1031	2	35 x 10 mm	70	70			140
KP1252	3	50 x 12 mm	65	95	65		225
KP1873	4	75 x 18 mm	120	165	165	120	570

Scatola di derivazione
Derivation box

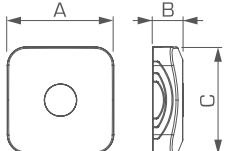
Articolo Item	A mm	B mm	C mm
KPD	100	30	100
			

Derivazione da battiscopa
Derivation from skirting trunkings

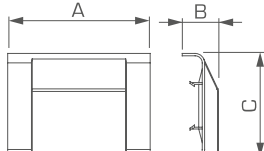
Articolo Item	A mm	B mm	C mm
KPA70	120	30	72
KPA100	160	38	103
			

Colori disponibili: (.1) Grigio RAL7030, (.2) Nero RAL7021, (.3) Bianco RAL9010, (.5) Marrone RAL8014, (.AL) Verniciato alluminio, (A) Alluminio anodizzato (KR) Verniciato Corten

Available colours: (.1) Grey RAL7030, (.2) Black RAL7021, (.3) White RAL9010, (.5) Brown RAL8014, (.AL) Aluminium painted, (A) Aluminium anodized, (KR) Korten painted

Angolo interno preformato Preformed internal angle	Angolo esterno preformato Preformed external angle	Terminale in alluminio Aluminium end piece	Scatola di derivazione Derivation box	Torretta 8 moduli 8 modules turrets	Torretta 8 moduli autoportanti 8 self-supporting module turret	Torretta 6 moduli 6 modules turrets
			KPD.1 KPD.2 KPD.3 KPD.5 KPD.AL	KP2504.1 KP2504.2 KP2504.3 KP2504.AL KP2504.KR	KP2504L.2 KP2504L.3 KP2504L.AL	KP503.1 KP503.2
KPI1873.3 KPI1873A	KPA1873.3 KPA1873A	KPE1873A				



Torretta porta apparecchi bifacciale 3+3 moduli Bifacial socket box 3+3 modules

Articolo Item	A mm	B mm	C mm	D mm
KP503	150	140	135	83,5

Torretta porta apparecchi bifacciale 4+4 moduli Bifacial socket box 4+4 modules

Articolo Item	A mm	B mm	C mm	D mm
KP2504	200	140	135	108,5

TORA

Torrette bifacciali

Bifacial turrets





Caratteristiche Tecniche

- Torretta in Abs
- Resistenza all'urto IK08 (5J)
- Grado di protezione IP40
- Espandibili in orizzontale
- Può collegarsi con canali sopra pavimento

Technical Features

- Abs Turret
- Impact resistance IK08 (5J)
- Protection degree IP40
- Expandable horizontally
- Can be connected with floor trunking

Riferimenti a Norme

- La linea è conforme alla norma CEI EN 50085-2-2
- La linea è conforme alla norma CEI EN 50085-2-4
- La linea è conforme alla Direttiva RoHS 2015/863/EU
- La linea è conforme alla Direttiva B.T. 2009/95/CE

Norms Reference

- The system complied to CEI EN 50085-2-2
- The system complied to CEI EN 50085-2-4
- The system complied to RoHS 2015/863/EU
- The system complied to L.V.D. 2009/95/CE

Marchi e Certificazioni

- Marchio IMQ riferimento n° CA02.01017
- Marcatura CE

Marks and Certifications

- Mark IMQ reference n° CA02.01017
- CE Marking

Colori disponibili

- Grigio RAL7030, Bianco RAL9010, Nero RAL7021, verniciato Alluminio, verniciato Corten

Available colours

- Grey RAL7030, White RAL9010, Black RAL7021, Aluminum painted, Korten painted

Torrette bifacciali max 8 moduli, in plastica
Bifacial turrets max 8 modules, of plastic



Articolo Item		Colore Color	Descrizione Description	A mm	B mm	C mm	D mm
	KP2504.1	Grigio Grey	<p>Per 2 supporti da 4 moduli per lato interasse 108,5 mm standard italiano</p> <p>For 2 supports of 4 modules each side centres 108.5 mm Italian standard</p>	200	140	135	108,5
	KP2504.2	Nero Black					
	KP2504.3	Bianco White					
	KP2504.AL	Verniciato Alluminio Aluminium painted					
	KP2504.KR	Verniciato Corten Korten painted					



Torrette bifacciali max 8 moduli, in plastica

Bifacial turrets max 8 modules, of plastic

Articolo Item		Colore Color	Descrizione Description	A mm	B mm	C mm	D mm
	KP2504L.2	Nero Black	<p>AUTOPORTANTE per 4 moduli per lato con attacchi BTicino LivingLight standard italiano</p> <p>SELF-SUPPORTING for 4 modules each side with coupling BTicino livingLight italian standard</p>	200	140	135	108,5
	KP2504L.3	Bianco White					
	KP2504L.AL	Alluminio Aluminium					

Torrette bifacciali max 6 moduli, in plastica

Bifacial turrets max 6 modules, of plastic

Articolo Item		Colore Color	Descrizione Description	A mm	B mm	C mm	D mm
	KP503.1	Grigio Grey	<p>Per 2 supporti da 3 moduli per lato interasse 83,5 mm standard italiano</p> <p>For 2 supports of 3 modules each side centres 83.5 mm Italian standard</p>	150	140	135	83,5
	KP503.2	Nero Black					
	KP503.3	Bianco White					



Twist

96

Torrette a scomparsa filo pavimento
Flush floor outlet socket boxes



Twin *Monofacciali*

108

Torrette e colonne in ALLUMINIO
Turrets and office-poles of ALUMINIUM



Twin *Bifacciali*

118

Torrette e colonne in ALLUMINIO
Turrets and office-poles of ALUMINIUM



Triwer-UP

132

Torrette multipresa in ALLUMINIO
Multisocket turrets of ALUMINIUM



Triwer

140

Moduli multipresa in ALLUMINIO
Multisocket modules of ALUMINIUM



Skyline

150

Torrette multipresa in ALLUMINIO
Multisocket turrets of ALUMINIUM



Evodesk

158

Torrette estraibili in ALLUMINIO
Pop-up turrets of ALUMINIUM



Evomod

166

Moduli elettrificabili in ALLUMINIO
Wiring modules of ALUMINIUM



E-Desk

174

Componenti per l'elettificazione
dei posti di lavoro
Components for workstation
electrification



Info TECH

182

Norme e certificazioni
Norms and certification

TWIST

Torrette a scomparsa filo pavimento

Flush floor outlet socket boxes

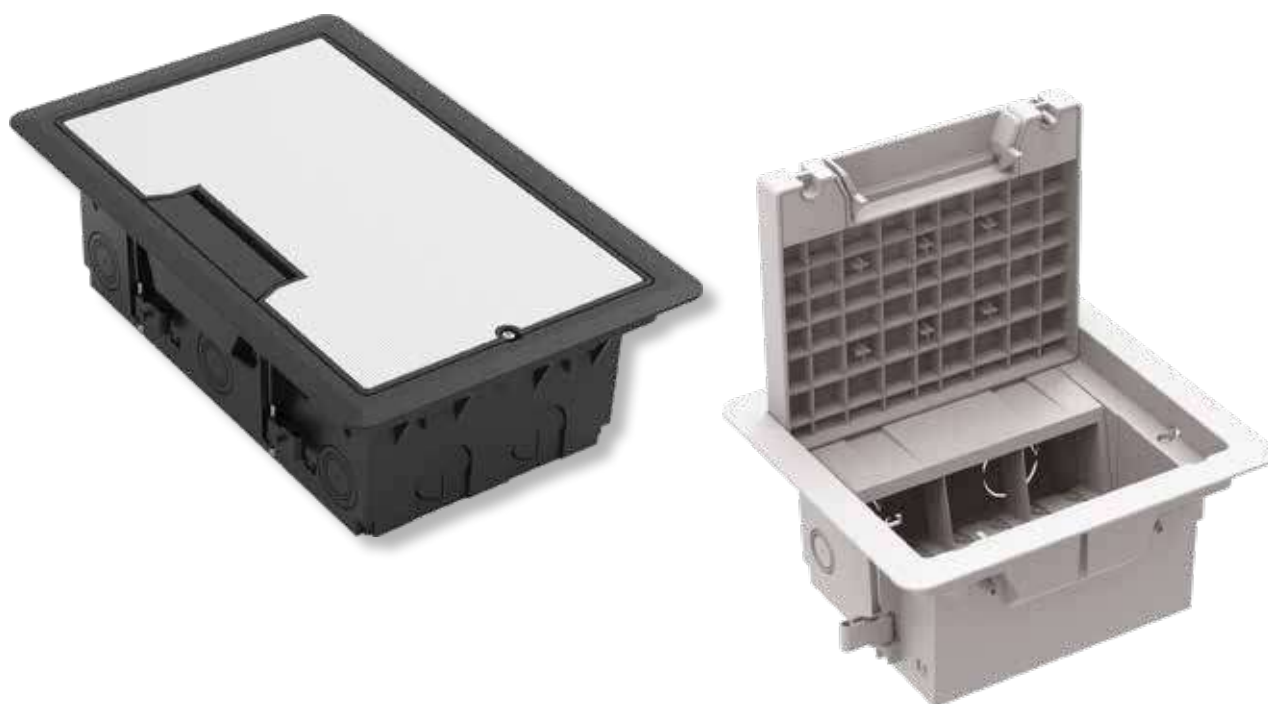



Caratteristiche Tecniche

- Scatola ed accessori in plastica PC+ABS rinforzato
- Apertura coperchio con attrezzo
- Resistenza al carico puntuale 1500 N (Circa 150 kg)
- Resistenza al carico distribuito 3000 N (Circa 300 kg)

Technical Features

- PC+ABS reinforced plastic box and accessories
- Cover disassembling with tool
- Ferrule load resistance 1500 N (About 150 Kg)
- Distributed load resistance 3000 N (About 300 Kg)

Grado di protezione

- IP52 tra cornice e pavimento
- IP40 per coperchio
- IP20 ingresso cavi

Protection Degree

- IP52 between frame and floor
- IP40 for cover
- IP20 Input cable point

Riferimenti a Norme

- La linea è conforme alla norma CEI EN 60670-23
- La linea è conforme alla norma CEI EN 50085-2-2
- La linea è conforme alla Direttiva RoHS 2015/863/EU
- La linea è conforme alla Direttiva B.T. 2009/95/CE

Norms Reference

- The system complied to CEI EN 60670-23
- The system complied to CEI EN 50085-2-2
- The system complied to RoHS 2015/863/EU
- The system complied to L.V.D. 2009/95/CE

Marchi e Certificazioni

- Marchio IMQ riferimento n° CA02.05791
- Marcatura CE

Marks and Certifications

- Mark IMQ reference n° CA02.05791
- Marking CE

Colori disponibili





- Grigio RAL7040, Nero RAL7021

Available colours

- Grey RAL7040, Black RAL7021

Torrette a scomparsa vuote per 1 supporto
Empty flush floor box for 1 support frame



Articolo Item	Colore Color	Coperchio Cover	A mm	B mm	C mm	D mm	E mm
 NEW SFP04	Grigio Grey	Standard reversibile Reversible standard	222	197	164	189	102
 NEW SFP04X	Grigio Grey	Inserto in acciaio inox Stainless steel insert					
 NEW SFP04.2	Nero Black	Standard reversibile Reversible standard					
 NEW SFP04X.2	Nero Black	Inserto in acciaio inox Stainless steel insert					

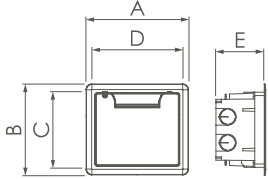

Torrette a scomparsa vuote per 2 supporti
Empty flush floor box for 2 support frames



Articolo Item	Colore Color	Coperchio Cover	A mm	B mm	C mm	D mm	E mm
 SFP08	Grigio Grey	Standard reversibile Reversible standard	339	222	188	305	102
 SFP08X	Grigio Grey	Inserto in acciaio inox Stainless steel insert					
 SFP08.2	Nero Black	Standard reversibile Reversible standard					
 SFP08X.2	Nero Black	Inserto in acciaio inox Stainless steel insert					



Torrette a scomparsa vuote per 4 supporti Empty flush floor box for 4 support frames



Articolo Item		Colore Color	Coperchio Cover	A mm	B mm	C mm	D mm	E mm
	SFP16	Grigio Grey	Standard reversibile Reversible standard	339	374	340	305	102
	SFP16X	Grigio Grey	Inserto in acciaio inox Stainless steel insert					
	SFP16.2	Nero Black	Standard reversibile Reversible standard					
	SFP16.2X	Nero Black	Inserto in acciaio inox Stainless steel insert					

Guarnizioni per bordo torrette Seal for underfloor box



Articolo Item		Per torrette For turrets	
	SGA04	NEW	SFP04
	SGA08		SFP08 / SFP12 / SFP06 / SFP09
	SGA16		SFP16 / SFP24 / SFP12-45 / SFP18-45

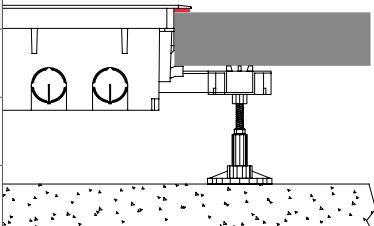

Pomello in alluminio per apertura manuale Aluminium knob for manual opening











Articolo Item	A mm	B mm	C mm	Dimensioni Dimensions
ST-BOX	26	15	3	



Supporti porta apparecchi
Support frame for devices



Articolo Item		Colore Color	Descrizione Description
	SMP43	Grigio Grey	Supporto universale per telai a 4 moduli standard italiano con riduttore a 3 moduli di qualsiasi produttore (per placche con dimensione massima 142x86 mm) Universal support for 4-module frames Italian standard with reducing piece for 3 modules of any manufacturer (for plates with maximum dimension 142x86 mm)
	SMP43.2	Nero Black	
	SMP6V	Grigio Grey	Supporto autoportante con attacchi a scatto per massimo 6 moduli della serie Vimar Plana (le prese si applicano a scatto direttamente sul supporto) Self-supporting frame with coupling for maximum 6 modules Vimar Plana (the sockets snap directly onto the frame)
	SMP6V.2	Nero Black	
	SMP6L	Grigio Grey	Supporto autoportante con attacchi a scatto per massimo 6 moduli della serie BTicino Living Light (le prese si applicano a scatto direttamente sul supporto) Self-supporting frame with coupling for maximum 6 modules BTicino Living Light (the sockets snap directly onto the frame)
	SMP6L.2	Nero Black	
	SMP6M	Grigio Grey	Supporto autoportante con attacchi a scatto per massimo 6 moduli della serie BTicino Matix (le prese si applicano a scatto direttamente sul supporto) Self-supporting frame with coupling for maximum 6 modules BTicino Matix (the sockets snap directly onto the frame)
	SMP6M.2	Nero Black	
	SMP6A	Grigio Grey	Supporto autoportante con attacchi a scatto per massimo 6 moduli della serie AVE 44 (le prese si applicano a scatto direttamente sul supporto) Self-supporting frame with coupling for maximum 6 modules AVE 44 (the sockets snap directly onto the frame)
	SMP6A.2	Nero Black	
	SMP45	Grigio Grey	Supporto autoportante con attacchi a scatto per massimo 3 moduli 45x45 mm (le prese si applicano a scatto direttamente sul supporto) Self-supporting frame with coupling for maximum 3 modules 45x45 mm (the sockets snap directly onto the frame)
	SMP45.2	Nero Black	
	SMP11	Grigio Grey	Supporto per interruttori modulari massimo 2 moduli da 17,5 mm Support frame for modular switches maximum 2 modules of 17,5 mm
	SMP11.2	Nero Black	
	SMP14	Grigio Grey	Supporto per interruttori modulari massimo 4 moduli da 17,5 mm Support frame for modular switches maximum 4 modules of 17,5 mm
	SMP14.2	Nero Black	

Supporti porta apparecchi in orizzontale standard francese Supports frames for devices with French standard



Articolo Item	Colore Color	Descrizione Description
	SMF45-3 Grigio Grey	Supporto piano autoportante con attacchi a scatto per massimo 3 moduli 45x45 mm , installabile su scatola SFP04 o SFP08 (le prese si applicano a scatto direttamente sul supporto) Flat self-supporting frame with coupling for maximum 3 modules 45x45 mm , installable only on SFP16 box (the sockets snap directly onto the frame)
	SMF45-3.2 Nero Black	
	SMF45-6 Grigio Grey	Supporto piano autoportante con attacchi a scatto per massimo 6 moduli 45x45 mm , installabile solo su scatola SFP16 (le prese si applicano a scatto direttamente sul supporto) Flat self-supporting frame with coupling for maximum 6 modules 45x45 mm , installable only on SFP16 box (the sockets snap directly onto the frame)
	SMF45-6.2 Nero Black	

Cassaforma in lamiera con coperchio e adattatori Formwork of galvanized sheet iron with cover and adapters



Articolo Item	Per torrette For turrets	A mm	B mm	C mm	D mm	E mm	Dimensioni Dimension
	SFP04	214	236	165	78	103	
	SFP08 SFP12 SFP06 SFP09	236	310	191	78	103	
	SFP16 SFP24 SFP12-45 SFP18-45	388	310	343	78	103	

Cassaforma annegata nel calcestruzzo Formwork embedded in concrete

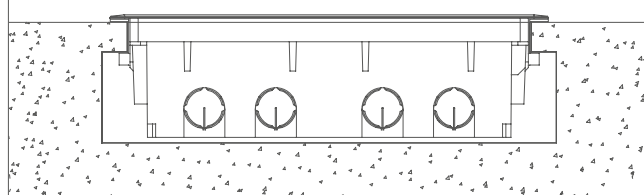

Gli adattatori hanno delle pretranciature, 2 per tubi $\varnothing 20$ o $\varnothing 25$ mm e 1 per canale 30x75 mm o 30x110 mm

The adapters have precuttings, 2 for pipes $\varnothing 20$ or $\varnothing 25$ mm and 1 for trunking 30x75 mm or 30x110 mm

Torrette complete di supporti porta apparecchi Turrets with supports frames



Articolo Item		Colore Color	Coperchio Cover	Descrizione Description
	SFP08-2M	Grigio Grey	Standard reversibile Reversible standard	Moduli totali 8 Torretta fornita con 2 supporti universali articolo SMP43 per 4 moduli standard ITALIANO (con riduttore a 3 moduli)
	SFP08-2M.2	Nero Black		
	SFP08-2MX	Grigio Grey	Inserto in acciaio inox Stainless steel insert	
	SFP08-2MX.2	Nero Black		
	SFP12V	Grigio Grey	Standard reversibile Reversible standard	Moduli totali 12 Torretta fornita con 2 supporti AUTOPORTANTI articolo SMP6V per 6 moduli VIMAR Plana
	SFP12VX	Grigio Grey	Inserto in acciaio inox Stainless steel insert	
	SFP12L	Grigio Grey	Standard reversibile Reversible standard	Moduli totali 12 Torretta fornita con 2 supporti AUTOPORTANTI articolo SMP6L per 6 moduli BTicino LivingLight
	SFP12LX	Grigio Grey	Inserto in acciaio inox Stainless steel insert	
	SFP12A	Grigio Grey	Standard reversibile Reversible standard	Moduli totali 12 Torretta fornita con 2 supporti AUTOPORTANTI articolo SMP6A per 6 moduli AVE44
	SFP12AX	Grigio Grey	Inserto in acciaio inox Stainless steel insert	

Torrette complete di supporti porta apparecchi Turrets with supports frames



Articolo Item		Colore Color	Coperchio Cover	Descrizione Description
	SFP16-4	Grigio Grey	Standard reversibile Reversible standard	<p>Moduli totali 16 Torretta fornita con 4 supporti universali articolo SMP43 per 4 moduli standard ITALIANO (con riduttore a 3 moduli)</p> <p>Total modules 16 Turret supplied with 4 universal supporting frames item SMP43 for 4 modules ITALIAN standard (with reducer for 3 modules)</p>
	SFP16-4.2	Nero Black		
	SFP16-4X	Grigio Grey	Inserto in acciaio inox Stainless steel insert	
	SFP16-4X.2	Nero Black		
	SFP24V	Grigio Grey	Standard reversibile Reversible standard	<p>Moduli totali 24 Torretta fornita con 4 supporti AUTOPORTANTI articolo SMP6V per 6 moduli VIMAR Plana</p> <p>Total modules 24 Turret supplied with 4 self-supporting frames item SMP6V for 6 modules VIMAR Plana</p>
	SFP24VX	Grigio Grey	Inserto in acciaio inox Stainless steel insert	
	SFP24L	Grigio Grey	Standard reversibile Reversible standard	<p>Moduli totali 24 Torretta fornita con 4 supporti AUTOPORTANTI articolo SMP6L per 6 moduli BTicino LivingLight</p> <p>Total modules 24 Turret supplied with 4 self-supporting frames item SMP6L for 6 modules BTicino LivingLight</p>
	SFP24LX	Grigio Grey	Inserto in acciaio inox Stainless steel insert	
	SFP24A	Grigio Grey	Standard reversibile Reversible standard	<p>Moduli totali 24 Torretta fornita con 4 supporti AUTOPORTANTI articolo SMP6A per 6 moduli AVE44</p> <p>Total modules 24 Turret supplied with 4 self-supporting frames item SMP6A for 6 modules AVE44</p>
	SFP24AX	Grigio Grey	Inserto in acciaio inox Stainless steel insert	

Torrette complete di supporti porta apparecchi Turrets with supports frames



Articolo Item		Colore Color	Coperchio Cover	Descrizione Description
	SFP06-45	Grigio Grey	Standard reversibile Reversible standard	Moduli totali 6 Torretta fornita con 2 supporti AUTOPORTANTI articolo SMP45 per 3 moduli 45x45 mm standard Francese
	SFP06-45.2	Nero Black		Total modules 6 Turret supplied with 2 self-supporting frames item SMP45 for 3 modules 45x45 mm French standard
	SFP12-45	Grigio Grey		Moduli totali 12 Torretta fornita con 4 supporti AUTOPORTANTI articolo SMP45 per 3 moduli 45x45 mm standard Francese
	SFP12-45.2	Nero Black		Total modules 12 Turret supplied with 4 self-supporting frames item SMP45 for 3 modules 45x45 mm French standard

Torrette complete di supporti porta apparecchi Turrets with supports frames



Articolo Item		Colore Color	Coperchio Cover	Descrizione Description
	SFP09-45F	Grigio Grey	Standard reversibile Reversible standard	Moduli totali 9 Torretta fornita con 3 supporti piatti AUTOPORTANTI articolo SMF45-3 per 3 moduli 45x45 mm standard Francese
	SFP09-45F.2	Nero Black		Total modules 9 Turret supplied with 3 flat self-supporting frames item SMF45-3 for 3 modules 45x45 mm French standard
	SFP18-45F	Grigio Grey		Moduli totali 18 Torretta fornita con 3 supporti piatti AUTOPORTANTI articolo SMF45-6 per 6 moduli 45x45 mm standard Francese
	SFP18-45F.2	Nero Black		Total modules 18 Turret supplied with 3 flat self-supporting frames item SMF45-6 for 6 modules 45x45 mm French standard

3 soluzioni diverse per i coperchi 3 different solutions for the covers

(1) Coperchio versione standard utilizzando il lato liscio. **(2)** Per applicare una mattonella, moquette o parquet utilizzare il bassofondo sul retro del coperchio standard.

(1) Standard version cover using the smooth side. **(2)** To apply a tile, carpet or parquet use the embedding on the back of the standard cover.

Spessore max 7 mm
Thickness max 7 mm

(3) Coperchio con inserto in acciaio inox antiscivolo.

(3) Cover with insert in non-slip stainless steel.

Articolo Item			Articolo Item		
4 moduli 4 modules	8 moduli 8 modules	16 moduli 16 modules	4 moduli 4 modules	8 moduli 8 modules	16 moduli 16 modules
SFP04 SFP04.2	SFP08 SFP08.2	SFP16 SFP16.2	SFP04X SFP04X.2	SFP08X SFP08X.2	SFP16X SFP16X.2

1

2

3

Spessore del pavimento Thickness of floor		Altezza dal pavimento Height from floor
A mm		B mm
MIN	MAX	MIN
20	60	100 mm

SFP04

SFP08

SFP16

Articolo Item	A mm	B mm
SFP04	167	194
SFP08	191	310
SFP16	343	310

Dimensione del foro sul pavimento
Size of the hole to be made on the floor

Vantaggi del sistema Advantages of the system



Chiusura di sicurezza

Un sistema esclusivo di chiusura del coperchio, mediante una vite speciale con filettatura metrica, che si impegna in una boccia in ottone assicurata alla base, evita sgradevoli manomissioni o modifiche non volute.

Safe closing

The boxes of the line Twist have an exclusive closing system for the cover through a special screw with metric thread which enters a brass bush fixed to the base. Such closing system avoids any unwanted alteration.



Uscita cavi

Per non danneggiare pericolosamente i cavi contenuti all'interno della scatola a filo pavimento, la forma interna ed esterna della zona di uscita cavi è smussata, in modo tale da facilitare la curvatura dei cavi al suo interno.

Cable exit

In order to not damage dangerously the cables contained in the box, both the internal and external shape of the cable exit zone is rounded off, so that it is easier to bend the cables.



Rimozione del coperchio

I coperchi sono facilmente estraibili dalla base della scatola a filo pavimento, in modo tale da evitare graffi e rotture del coperchio stesso e facilitando la lavorazione da parte dell'operatore all'interno della torretta. Inoltre è possibile applicare un rivestimento all'interno del bassofondo.

Removal of the Cover

The covers can be easily removed from the base of the box in order to avoid scratches and breaking of the cover itself, and to make it easier for the operator to work within the box. it is also possible apply a tile, carpet or parquet use the embedding on the back of the cover.



Tenuta cavi

Per facilitare la chiusura del coperchio è presente all'interno della scatola un ponticello che raggruppa i cavi in modo ordinato, evitando l'usura ed il danneggiamento involontario dei cavi contenuti al suo interno.

Cable keeping

In order to make it easier to close the cover, within the box there is a bond which gathers the cables tidily. Such system avoids any wear and tear and unintentional damages of the cables which are inside.

Vantaggi del sistema Advantages of the system



Tenuta coperchio

Il ponticello, oltre ad avere la funzione di raccolta cavi, viene utilizzato anche per tenere sollevato il coperchio durante l'inserimento dei cavi o per la manutenzione, evitandone la caduta accidentale sulle mani dell'operatore.

Cover keeping

Besides gathering the cables, the bond is also used in order to keep the cover open while inserting the cables and for the maintenance, avoiding so the falling over the hands of the user.



Facilità di applicazione

Si possono montare su pavimenti flottanti con mattonelle di spessore da 20 a 60 mm. Il sistema esclusivo di ritorno dei piedini di tenuta, mediante un elastico, permette un agevole montaggio e smontaggio della scatola.

Easy to install

They can be mounted on floating floors with tiles having a thickness from 20 to 60 mm. The feet are re-positioned by a rubber, and this allows an easy assembly and disassembly of the box.



Mostrine universali e autoportanti

All'interno delle torrette a scomparsa è possibile applicare 3 tipologie di mostrina: 1) Mostrina universale per il montaggio di telai e placche a 3/4 moduli con standard italiano di qualsiasi produttore, con dimensione massima della placca inseribile di 142x86 mm; 2) Mostrina autoportante in verticale per il montaggio a scatto di prese con standard italiano o standard francese; 3) Mostrina autoportante in piano per il montaggio di prese con standard francese 45x45 mm (standard adeguato per il solo mercato estero).

Universal and self-supporting frames

Inside the retractable turrets it is possible to apply 3 types of frames: 1) Universal frame for mounting frames and plates with 3/4 modules with Italian standard of any manufacturer, with a maximum size of the insertable plate of 142x86 mm; 2) Vertical self-supporting frame for snap-fit assembly of Italian or French standard sockets; 3) Self-supporting flat frame for mounting 45x45 mm French standard sockets (standard suitable for the foreign market only).

TWIN *Monofacciale*

PERSONALIZZABILE
CUSTOMIZABLE

Torrette e colonne monofacciali
in ALLUMINIO

Monofacial turrets and office poles
of ALUMINIUM





Caratteristiche Tecniche

- Profilo in Alluminio
- Coperchio in Alluminio o PVC
- Accessori in ABS
- Apertura con attrezzo
- Resistenza all'urto IK 08 (5J)
- Grado di protezione IP40

Technical Features

- Aluminium profile
- Aluminium or PVC cover
- ABS accessories
- Opening only with tool
- Mechanical protection IK 08 (5J)
- Protection degree IP40

Riferimenti a Norme

- Conforme alla norma CEI EN 50085-2-2
- Conforme alla norma CEI EN 50085-2-4
- Conforme alla Direttiva RoHS 2015/863/EU
- Conforme alla Direttiva B.T. 2009/95/CE

Norms Reference

- Complies with standard CEI EN 50085-2-2
- Complies with standard CEI EN 50085-2-4
- Compliant with RoHS Directive 2015/863/EU
- The system complied to L.V.D. 2009/95/CE

Marchi e Certificazioni

- Marchio IMQ riferimento n° CA02.01015 (Torrette)
- Marchio IMQ riferimento n° CA02.01019 (Colonne)
- Marcatura CE

Marks and Certifications

- Mark IMQ reference n° CA02.01015 (Turrets)
- Mark IMQ reference n° CA02.01019 (Columns)
- CE Marking

Colori disponibili

- Alluminio verniciato Bianco
- Alluminio verniciato Nero goffrato
- Alluminio spazzolato e anodizzato naturale



Available colours

- White painted Aluminium
- Black goffred painted Aluminium
- Brushed and natural anodized Aluminium

Torrette monofacciali in alluminio

Monofacial turrets in aluminium



Articolo Item		Colore Color	Dotazione Equipment	A mm	B mm	C mm
	CDP30A3	Alluminio bianco White Aluminium	1 torretta alluminio 30 cm, 1 terminale superiore, 1 base a pavimento, 1 scatola 3, 4, 7 moduli, 1 mostrina 3, 4, 7 moduli, 1 morsetto di terra Alimentazione da sottopavimento	300	115	65
	CDP30VN	Alluminio Nero Black Aluminium				
	CDP30AA	Alluminio anodizzato Anodized Aluminium	1 aluminium turret 30 cm, 1 upper terminal, 1 floor base, 1 box 3, 4, 7 modules, 1 frame 3, 4, 7 modules, 1 ground terminal			
	CDP30VA	Alluminio anodizzato accessori Neri Anodized Aluminium Black accessories	Underfloor power supply			
	CDP50A3	Alluminio bianco White Aluminium	1 torretta alluminio 50 cm, 1 terminale superiore, 1 base a pavimento, 2 scatole 3, 4, 7 moduli, 2 mostrine 3, 4, 7 moduli, 1 morsetto di terra Alimentazione da sottopavimento	500	115	65
	CDP50VN	Alluminio Nero Black Aluminium				
	CDP50AA	Alluminio anodizzato Anodized Aluminium	1 aluminium turret 50 cm, 1 upper terminal, 1 floor base, 2 boxes 3, 4, 7 modules, 2 frames 3, 4, 7 modules, 1 ground terminal			
	CDP50VA	Alluminio anodizzato accessori Neri Anodized Aluminium Black accessories	Underfloor power supply			
	CDP70A3	Alluminio bianco White Aluminium	1 torretta alluminio 70 cm, 1 terminale superiore, 1 base a pavimento, 2 scatole 3, 4, 7 moduli, 2 mostrine 3, 4, 7 moduli, 1 morsetto di terra Alimentazione da sottopavimento	700	115	65
	CDP70VN	Alluminio Nero Black Aluminium				
	CDP70AA	Alluminio anodizzato Anodized Aluminium	1 aluminium turret 70 cm, 1 upper terminal, 1 floor base, 2 boxes 3, 4, 7 modules, 2 frames 3, 4, 7 modules, 1 ground terminal			
	CDP70VA	Alluminio anodizzato accessori Neri Anodized Aluminium Black accessories	Underfloor power supply			

.2

Plastica nera
Black plastic

.3

Plastica bianca
White plastic

.AL

Plastica verniciata alluminio
Aluminium painted plastic

Componenti singoli per la personalizzazione Single components for the customization

Articolo Item	Descrizione Description	Colori Colours
A	BU65115 Profilo torretta Turret profile	A, A3, VN
B	BO80 Coperchio Cover	.2,.3, A,A3,VN
C	BASE-TWIN1 Base per torretta con viti Base for turret with screws	.2, .3, .AL
D	686 Scatola universale 3, 4, 7 moduli Universal box 3, 4, 7 modules	
E	BS80-53 Mostrina in plastica 3, 4, 7 moduli Plastic frame 3, 4, 7 modules	.2, .3, .AL
	BS80-53 Mostrina in alluminio 3 moduli Aluminium frame 3 modules	A, A3, VN
	BS80-54 Mostrina in alluminio 4 moduli Aluminium frame 4 modules	A, A3, VN
	BS80-56 Mostrina in alluminio 7 moduli Aluminium frame 7 modules	A, A3, VN
F	605-4 Supporto fino a 4 interruttori modulari Support til 4 modular switches	
G	BS80-04 Mostrina in plastica per 605-4 Plastic frame for 605-4	.2, .3, .AL
H	SP660 Scatola con aggancio a scatto per: 2 moduli standard italiano, o 1 modulo standard tedesco, o 1 modulo standard inglese Socket box with click mounting for: 2 modules italian standard or 1 module german standard or 1 module english standard	
	SP664 Scatola con aggancio a scatto per 4 moduli standard italiano Socket box with click mounting for 4 modules italian standard	
	SP664E Scatola con aggancio a scatto per 2 moduli standard inglese Socket box with click mounting for 2 modules english standard	
	SP667 Scatola con aggancio a scatto per 7 moduli standard italiano Socket box with click mounting for 7 modules italian standard	
I	BE115 Terminale superiore End piece	.2, .3, .AL
L	BMT65 Morsetto di terra Ground terminal	

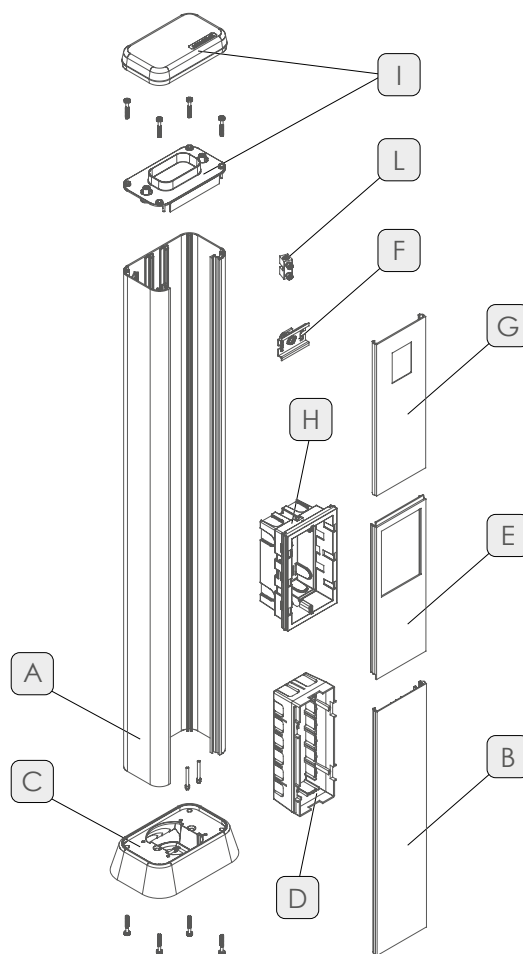

*Per ulteriori info tecniche vedi pagine 128/131

*For further technical info see pages 128/131

A Alluminio anodizzato
Anodized aluminium

A3 Alluminio verniciato bianco
White painted aluminium

VN Alluminio verniciato nero
Black painted aluminium





Colonne monofacciali telescopiche in alluminio

Telescopic monofacial office-poles in aluminium

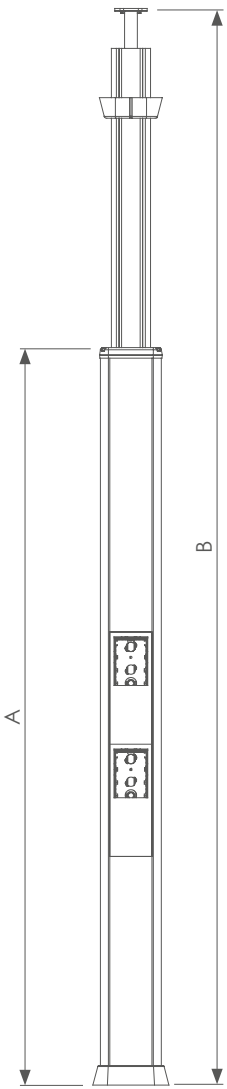
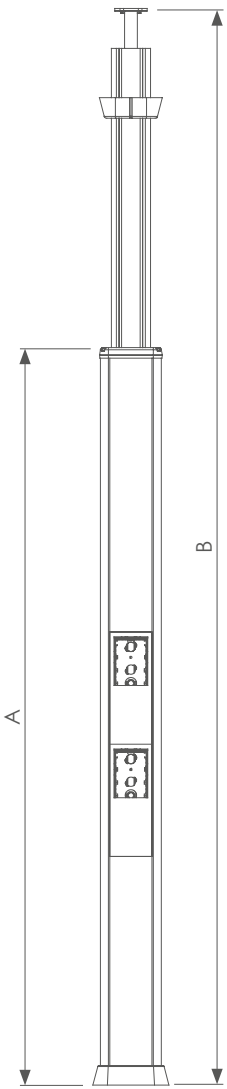

Articolo Item	Colore Color	Dotazione Equipment	A mm	B mm
	CB1333A3	Alluminio bianco White Aluminium	1500/2000	3300/3800
	CB1333VN	Alluminio Nero Black Aluminium		
	CB1333AA	Alluminio anodizzato Anodized Aluminium		
	CB1333VA	Alluminio anodizzato accessori Neri Anodized Aluminium Black accessories		
	CB1384A3	Alluminio bianco White Aluminium		
	CB1384VN	Alluminio Nero Black Aluminium		
	CB1384AA	Alluminio anodizzato Anodized Aluminium		
	CB1384VA	Alluminio anodizzato accessori Neri Anodized Aluminium Black accessories		
<p>Altezza da 270 a 330 cm</p> <p>1 colonna alluminio 1500 mm, 1 terminale superiore, 1 base a pavimento, 1 flangia di rifinitura, 2 scatole 3, 4, 7 moduli, 2 mostrine 3, 4, 7 moduli, 1 morsetto di terra</p> <p>Alimentazione da sottopavimento o controsoffitto</p> <p>Height from 270 to 330 cm</p> <p>1 aluminium column 1500 mm, 1 upper terminal, 1 floor base, 1 finishing flange, 2 boxes 3, 4, 7 modules, 2 frames 3, 4, 7 modules, 1 ground terminal</p> <p>Underfloor or countertop power supply</p>				
<p>Altezza da 270 a 380 cm</p> <p>1 colonna alluminio 2000 mm, 1 terminale superiore, 1 base a pavimento, 1 flangia di rifinitura, 2 scatole 3, 4, 7 moduli, 2 mostrine 3, 4, 7 moduli, 1 morsetto di terra</p> <p>Alimentazione da sottopavimento o controsoffitto</p> <p>Height from 270 to 380 cm</p> <p>1 aluminium column 2000 mm, 1 upper terminal, 1 floor base, 1 finishing flange, 2 boxes 3, 4, 7 modules, 2 frames 3, 4, 7 modules, 1 ground terminal</p> <p>Underfloor or countertop power supply</p>				

.2 Plastica nera
Black plastic

.3 Plastica bianca
White plastic

.AL Plastica verniciata alluminio
Aluminium painted plastic

Componenti singoli per la personalizzazione Single components for the customization

Articolo Item	Descrizione Description	Colori Colours	
A BU65115	Profilo colonna, barra fino 6 metri Office-pole profile, 6 meter bar	A, A3, VN	
B BO80	Coperchio, barra fino 4 m Cover, bar of 4 meters	.2,.3,A,A3,VN	
C BDS	Profilo telescopico in Alluminio Telescopic Aluminium profile	A, A3, VN	
D CS40	Coperchio per profilo telescopico Cover for telescopic profile	.2 .3 .AL	
E	BS80-53	Mostrina in plastica 3, 4, 7 moduli Plastic frame 3, 4, 7 modules	.2 .3 .AL
	BS80-53	Mostrina in alluminio 3 moduli Aluminium frame 3 modules	A, A3, VN
	BS80-54	Mostrina in alluminio 4 moduli Aluminium frame 4 modules	A, A3, VN
	BS80-56	Mostrina in alluminio 7 moduli Aluminium frame 7 modules	A, A3, VN
F MACCHINETTA	Regolazione telescopica Telescopic regulation		
G BASE-TWIN1	Base per colonna con viti Base for office-pole with screws	.2 .3 .AL	
H BE115F	Terminale superiore End piece	.2 .3 .AL	
I BF-BDS	Flangia di finitura per controsoffitto Finish frame for false ceiling	.2 .3 .AL	
L 686	Scatola 3-4-6-7 moduli Socket box 3-4-6-7 modules		
M GTR60-1	Separatore in plastica Separator of plastic		
N 605-4	Supporto fino a 4 interruttori modulari Support till 4 modular switches		
O BS80-04	Mostrina in plastica per 605-4 Plastic frame for 605-4	.2 .3 .AL	
P	SP660	Scatola con aggancio a scatto per: 2 moduli standard italiano, 1 modulo standard tedesco, 1 modulo standard inglese Socket box with click mounting for: 2 modules italian standard 1 module german standard 1 module english standard	
	SP664	Scatola con aggancio a scatto per 4 moduli standard italiano Socket box with click mounting for 4 modules italian standard	
	SP664E	Scatola con aggancio a scatto per 2 moduli standard inglese Socket box with click mounting for 2 modules english standard	
	SP667	Scatola con aggancio a scatto per 7 moduli standard italiano Socket box with click mounting for 7 modules italian standard	
Q BMT65	Morsetto di terra Ground terminal		

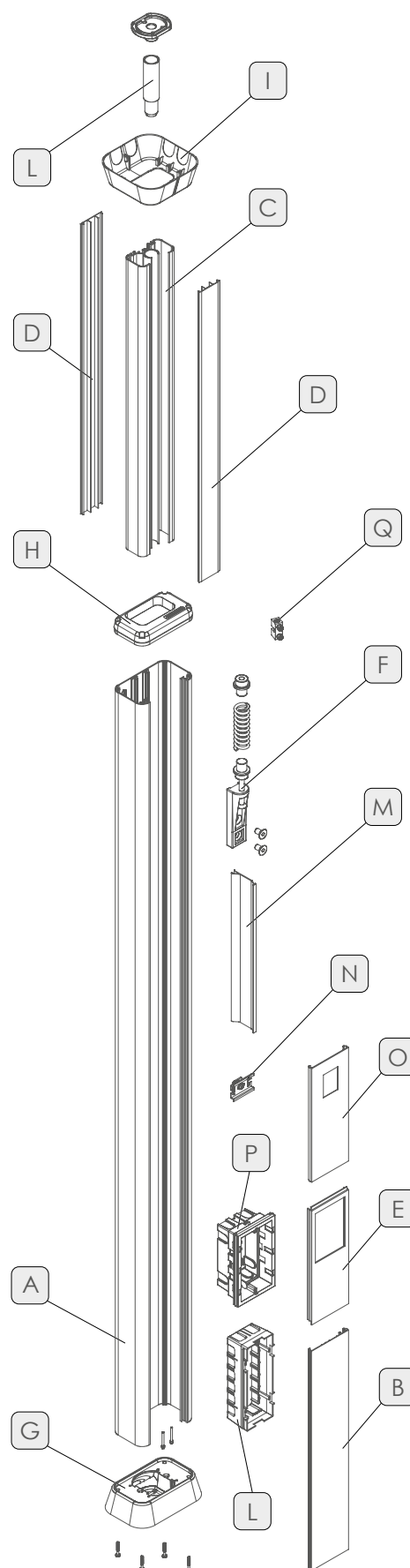

*Per ulteriori info tecniche vedi pagine 128/131

*For further technical info see pages 128/131

A Alluminio anodizzato
Anodized aluminium

A3 Alluminio verniciato bianco
White painted aluminium

VN Alluminio verniciato nero
Black painted aluminium

Colonne monofacciali mobili in alluminio
Movable monofacial office-poles in aluminium



Articolo Item		Colore Color	Dotazione Equipment	A mm	B mm	
	CBF200A3	Alluminio bianco White Aluminium	<p>Altezza da 270 a 400 cm</p> <p>1 colonna alluminio 2000 mm, 1 terminale superiore, 1 base a pavimento in acciaio verniciato nero 12 Kg, 1 guaina flessibile da Ø40 mm, 1 raccordo guaina/soffitto 2 scatole 3, 4, 7 moduli, 2 mostrine 3, 4, 7 moduli, 1 morsetto di terra</p> <p>Alimentazione da controsoffitto</p> <p>Height from 270 to 400 cm</p> <p>1 aluminium column 2000 mm, 1 upper terminal, 1 floor base in black painted steel 12 Kg, 1 flexible sheath of Ø40 mm, 1 sheath/ceiling connection 2 boxes 3, 4, 7 modules, 2 frames 3, 4, 7 modules, 1 ground terminal</p> <p>False ceiling power supply</p>	2000	2500	
	CBF200VN	Alluminio Nero Black Aluminium				
	CBF200AA	Alluminio anodizzato Anodized Aluminium				

.2 Plastica nera
Black plastic

.3 Plastica bianca
White plastic

.AL Plastica verniciata alluminio
Aluminium painted plastic

Componenti singoli per la personalizzazione Single components for the customization

Articolo Item	Descrizione Description	Colori Colours
A	BU65115 Profilo colonna, barre da 6 metri Office-pole profile, 6 meter bars	A, A3, VN
B	BO80 Coperchio, barra da 4 m Cover, bar of 4 meters	.2,.3,A,A3,VN
C	GS40 Guaina spiralata Ø40 mm Spiraled sheath Ø40 mm	Grigio Grey
	GS40N Guaina spiralata Ø40 mm Spiraled sheath Ø40 mm	Nero Black
D	RGS40M50 Raccordo M50 per guaina Ø40 mm Joint M50 for sheath Ø40 mm	Grigio Grey
	RGS40M50N Raccordo M50 per guaina Ø40 mm Joint M50 for sheath Ø40 mm	Nero Black
E	BS80-53 Mostrina in plastica 3, 4, 7 moduli Plastic frame 3, 4, 7 modules	.2, .3, .AL
	BS80-53 Mostrina in alluminio 3 moduli Aluminium frame 3 modules	A, A3, VN
	BS80-54 Mostrina in alluminio 4 moduli Aluminium frame 4 modules	A, A3, VN
	BS80-56 Mostrina in alluminio 7 moduli Aluminium frame 7 modules	A, A3, VN
F	BE115M Terminale superiore End piece	.2, .3, .AL
G	BASE-TWIN12 Base in acciaio verniciato peso 12 Kg Painted steel base weight 12 Kg	Nero Black
H	686 Scatola 3-4-6-7 moduli Socket box 3-4-6-7 modules	
I	GTR60-1 Separatore in plastica Separator of plastic	
L	605-4 Supporto fino a 4 interruttori modulari Support till 4 modular switches	
M	BS80-04 Mostrina in plastica per 605-4 Plastic frame for 605-4	.2, .3, .AL
N	SP660 Scatola con aggancio a scatto per: 2 moduli standard italiano, 1 modulo standard tedesco, 1 modulo standard inglese Socket box with click mounting for: 2 modules italian standard 1 module german standard 1 module english standard	
	SP664 Scatola con aggancio a scatto per 4 moduli standard italiano Socket box with click mounting for 4 modules italian standard	
	SP664E Scatola con aggancio a scatto per 2 moduli standard inglese Socket box with click mounting for 2 modules english standard	
	SP667 Scatola con aggancio a scatto per 7 moduli standard italiano Socket box with click mounting for 7 modules italian standard	
O	BMT65 Morsetto di terra Ground terminal	

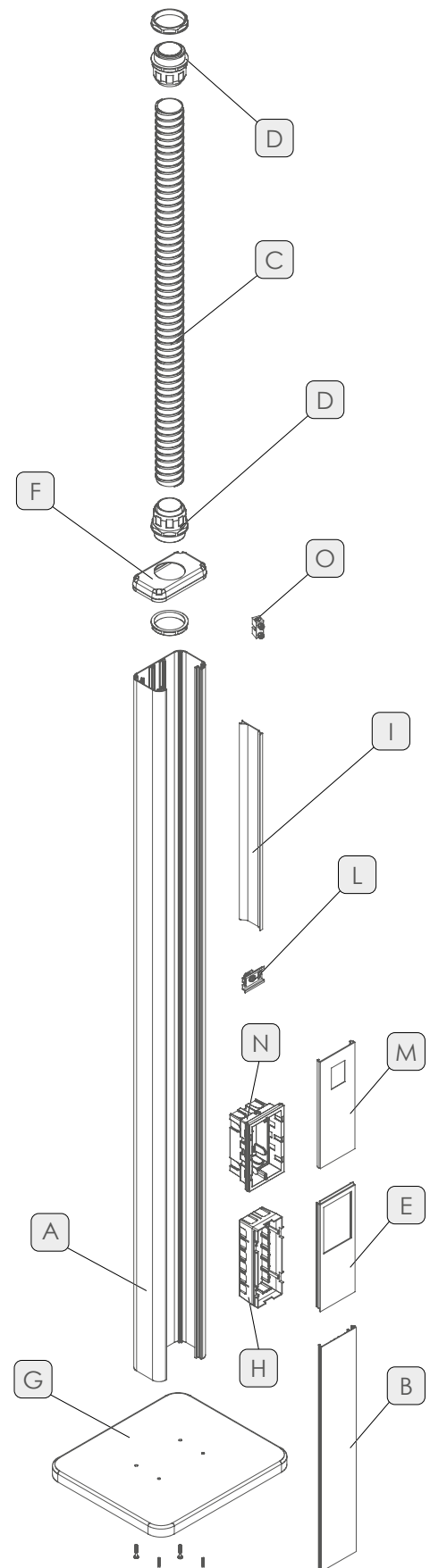

*Per ulteriori info tecniche vedi pagine 128/131

*For further technical info see pages 128/131

A Alluminio anodizzato
Anodized aluminium

A3 Alluminio verniciato bianco
White painted aluminium

VN Alluminio verniciato nero
Black painted aluminium

TWIN *Bifacciale*

PERSONALIZZABILE
CUSTOMIZABLE

Torrette e colonne bifacciali
in ALLUMINIO

Bifacial turrets and office poles
of ALUMINIUM





Caratteristiche Tecniche

- Profilo in Alluminio
- Coperchio in Alluminio o PVC
- Accessori in ABS
- Apertura con attrezzo
- Resistenza all'urto IK 08 (5J)
- Grado di protezione IP40

Technical Features

- Aluminium profile
- Aluminium or PVC cover
- ABS accessories
- Opening only with tool
- Mechanical protection IK 08 (5J)
- Protection degree IP40

Riferimenti a Norme

- Conforme alla norma CEI EN 50085-2-2
- Conforme alla norma CEI EN 50085-2-4
- Conforme alla Direttiva RoHS 2015/863/EU
- Conforme alla Direttiva B.T. 2009/95/CE

Norms Reference

- Complies with standard CEI EN 50085-2-2
- Complies with standard CEI EN 50085-2-4
- Compliant with RoHS Directive 2015/863/EU
- The system complied to L.V.D. 2009/95/CE

Marchi e Certificazioni

- Marchio IMQ riferimento n° CA02.01015 (Torrette)
- Marchio IMQ riferimento n° CA02.01019 (Colonne)
- Marcatura CE

Marks and Certifications

- Mark IMQ reference n° CA02.01015 (Turrets)
- Mark IMQ reference n° CA02.01019 (Columns)
- CE Marking

Colori disponibili



- Alluminio verniciato Bianco
- Alluminio verniciato Nero goffrato
- Alluminio spazzolato e anodizzato naturale

Available colours

- White painted Aluminium
- Black goffred painted Aluminium
- Brushed and natural anodized Aluminium

Torrette bifacciali in alluminio
Bifacial turrets in aluminium



Articolo Item		Colore Color	Dotazione Equipment	A mm	B mm	C mm
	12932A3	Alluminio bianco White Aluminium	1 torretta alluminio 30 cm, 1 terminale superiore, 1 base a pavimento, 2 scatole 3, 4, 7 moduli, 2 mostrine 3, 4, 7 moduli, 1 morsetto di terra Alimentazione da sottopavimento	300	115	118
	12932VN	Alluminio Nero Black Aluminium				
	12932AA	Alluminio anodizzato Anodized Aluminium	1 aluminium turret 30 cm, 1 upper terminal, 1 floor base, 2 boxes 3, 4, 7 modules, 2 frames 3, 4, 7 modules, 1 ground terminal			
	12932VA	Alluminio anodizzato accessori Neri Anodized Aluminium Black accessories	Underfloor power supply			
	12954A3	Alluminio bianco White Aluminium	1 torretta alluminio 50 cm, 1 terminale superiore, 1 base a pavimento, 4 scatole 3, 4, 7 moduli, 4 mostrine 3, 4, 7 moduli, 1 morsetto di terra Alimentazione da sottopavimento	500	115	118
	12954VN	Alluminio Nero Black Aluminium				
	12954AA	Alluminio anodizzato Anodized Aluminium	1 aluminium turret 50 cm, 1 upper terminal, 1 floor base, 4 boxes 3, 4, 7 modules, 4 frames 3, 4, 7 modules, 1 ground terminal			
	12954VA	Alluminio anodizzato accessori Neri Anodized Aluminium Black accessories	Underfloor power supply			
	12976A3	Alluminio bianco White Aluminium	1 torretta alluminio 70 cm, 1 terminale superiore, 1 base a pavimento, 4 scatole 3, 4, 7 moduli, 4 mostrine 3, 4, 7 moduli, 1 morsetto di terra Alimentazione da sottopavimento	700	115	118
	12976VN	Alluminio Nero Black Aluminium				
	12976AA	Alluminio anodizzato Anodized Aluminium	1 aluminium turret 70 cm, 1 upper terminal, 1 floor base, 4 boxes 3, 4, 7 modules, 4 frames 3, 4, 7 modules, 1 ground terminal			
	12976VA	Alluminio anodizzato accessori Neri Anodized Aluminium Black accessories	Underfloor power supply			

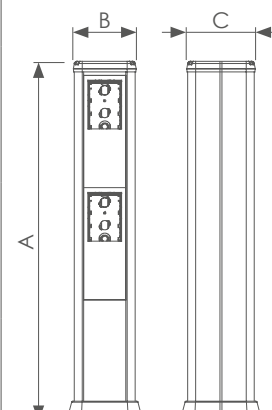
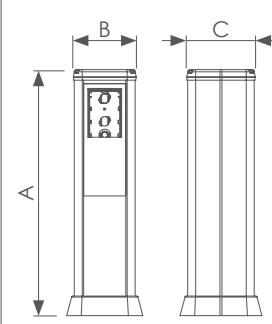
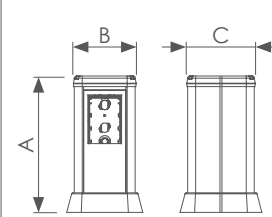

.2	Plastica nera Black plastic	.3	Plastica bianca White plastic	.AL	Plastica verniciata alluminio Aluminium painted plastic
----	--------------------------------	----	----------------------------------	-----	--

Componenti singoli per la personalizzazione Single components for the customization

Articolo Item	Descrizione Description	Colori Colours
A	BU120115 Profilo torretta Turret profile	A, A3, VN
B	BO80 Coperchio Cover	.2, .3, A, A3, VN
C	BASE-TWIN Base per torretta con viti Base for turret and screws	.2, .3, .AL
D	686 Scatola universale 3, 4, 7 moduli Universal box 3, 4, 7 modules	
E	BS80-53 Mostrina in plastica 3, 4, 7 moduli Plastic frame 3, 4, 7 modules	.2, .3, .AL
	BS80-53 Mostrina in alluminio 3 moduli Aluminium frame 3 modules	A, A3, VN
	BS80-54 Mostrina in alluminio 4 moduli Aluminium frame 4 modules	A, A3, VN
	BS80-56 Mostrina in alluminio 7 moduli Aluminium frame 7 modules	A, A3, VN
F	605-4 Supporto fino a 4 interruttori modulari Support til 4 modular switches	
G	BS80-04 Mostrina in plastica per 605-4 Plastic frame for 605-4	.2, .3, .AL
H	SP660 Scatola con aggancio a scatto per: 2 moduli standard italiano, 1 modulo standard tedesco, 1 modulo standard inglese Socket box with click mounting for: 2 modules italian standard 1 module german standard 1 module english standard	
	SP664 Scatola con aggancio a scatto per 4 moduli standard italiano Socket box with click mounting for 4 modules italian standard	
	SP664E Scatola con aggancio a scatto per 2 moduli standard inglese Socket box with click mounting for 2 modules english standard	
	SP667 Scatola con aggancio a scatto per 7 moduli standard italiano Socket box with click mounting for 7 modules italian standard	
I	BE120 Terminale superiore End piece	.2, .3, .AL
L	BMT65 Morsetto di terra Ground terminal	

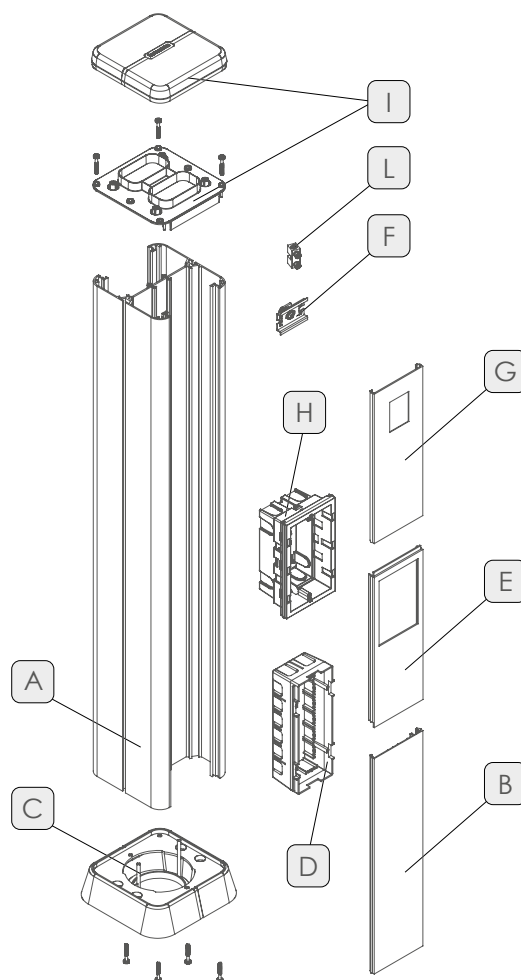

*Per ulteriori info tecniche vedi pagine 128/131

*For further technical info see pages 128/131

A Alluminio anodizzato
Anodized aluminium

A3 Alluminio verniciato bianco
White painted aluminium

VN Alluminio verniciato nero
Black painted aluminium





Colonne bifacciali telescopiche in alluminio

Telescopic bifacial office-poles in aluminium



Articolo Item	Colore Color	Dotazione Equipment	A mm	B mm
	129336A3	Alluminio bianco White Aluminium	1500/2000	3300/3800
	129336VN	Alluminio Nero Black Aluminium		
	129336AA	Alluminio anodizzato Anodized Aluminium	Altezza da 270 a 330 cm	
	129336VA	Alluminio anodizzato accessori Neri Anodized Aluminium Black accessories	n.1 colonna alluminio 1500 mm, n.1 terminale superiore, n.1 base a pavimento, n.1 flangia di rifinitura, n.4 scatole 3, 4, 7 moduli, n.4 mostrine 3, 4, 7 moduli, n.1 morsetto di terra Alimentazione sotto-pavimento o controsoffitto Height from 270 to 330 cm n.1 aluminium column 1500 mm, 1 upper terminal, 1 floor base, 1 finishing flange, n.4 boxes 3, 4, 7 modules, n.4 frames 3, 4, 7 modules, 1 ground terminal Underfloor or countertop power supply	
	129388A3	Alluminio bianco White Aluminium	Altezza da 270 a 380 cm	
	129388VN	Alluminio Nero Black Aluminium	n.1 colonna alluminio 2000 mm, n.1 terminale superiore, n.1 base a pavimento, n.1 flangia di rifinitura, n.4 scatole 3, 4, 7 moduli, n.4 mostrine 3, 4, 7 moduli, n.1 morsetto di terra Alimentazione sotto-pavimento o controsoffitto Height from 270 to 380 cm n.1 aluminium column 2000 mm, 1 upper terminal, 1 floor base, 1 finishing flange, n.4 boxes 3, 4, 7 modules, n.4 frames 3, 4, 7 modules, 1 ground terminal Underfloor or countertop power supply	
	129388AA	Alluminio anodizzato Anodized Aluminium	n.1 colonna alluminio 2000 mm, n.1 terminale superiore, n.1 base a pavimento, n.1 flangia di rifinitura, n.4 scatole 3, 4, 7 moduli, n.4 mostrine 3, 4, 7 moduli, n.1 morsetto di terra Alimentazione sotto-pavimento o controsoffitto Height from 270 to 380 cm n.1 aluminium column 2000 mm, 1 upper terminal, 1 floor base, 1 finishing flange, n.4 boxes 3, 4, 7 modules, n.4 frames 3, 4, 7 modules, 1 ground terminal Underfloor or countertop power supply	
	129388VA	Alluminio anodizzato accessori Neri Anodized Aluminium Black accessories	n.1 colonna alluminio 2000 mm, n.1 terminale superiore, n.1 base a pavimento, n.1 flangia di rifinitura, n.4 scatole 3, 4, 7 moduli, n.4 mostrine 3, 4, 7 moduli, n.1 morsetto di terra Alimentazione sotto-pavimento o controsoffitto Height from 270 to 380 cm n.1 aluminium column 2000 mm, 1 upper terminal, 1 floor base, 1 finishing flange, n.4 boxes 3, 4, 7 modules, n.4 frames 3, 4, 7 modules, 1 ground terminal Underfloor or countertop power supply	

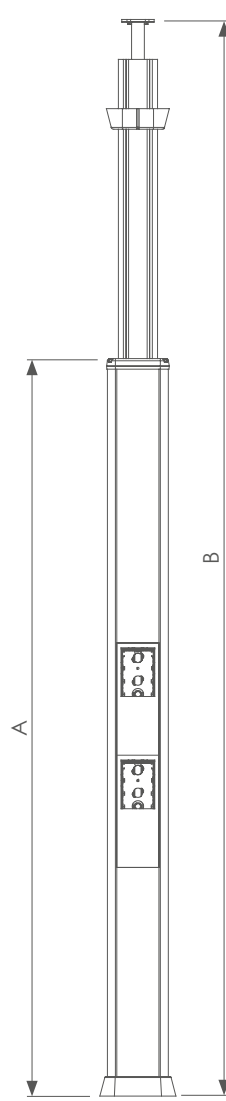

.2 Plastica nera
Black plastic

.3 Plastica bianca
White plastic

.AL Plastica verniciata alluminio
Aluminium painted plastic

Componenti singoli per la personalizzazione Single components for the customization

Articolo Item	Descrizione Description	Colori Colours
A	BU120115 Profilo colonna, barre da 6 metri Office-pole profile, 6 meter bars	A, A3, VN
B	BO80 Coperchio, barra fino 4 m Cover, bar of 4 meters	.2,.3,A,A3,VN
C	BDS Profilo telescopico in Alluminio Telescopic Aluminium profile	A, A3, VN
D	CS40 Coperchio per profilo telescopico Cover for telescopic profile	.2, .3, .AL
E	BS80-53 Mostrina in plastica 3, 4, 7 moduli Plastic frame 3, 4, 7 modules	.2, .3, .AL
	BS80-53 Mostrina in alluminio 3 moduli Aluminium frame 3 modules	A, A3, VN
	BS80-54 Mostrina in alluminio 4 moduli Aluminium frame 4 modules	A, A3, VN
	BS80-56 Mostrina in alluminio 7 moduli Aluminium frame 7 modules	A, A3, VN
F	MACCHINETTA Regolazione telescopica Telescopic regulation	
G	BASE-TWIN Base per colonna con viti Base for office-pole with screws	.2, .3, .AL
H	BE120F Terminale superiore End piece	.2, .3, .AL
I	BF-BDS Flangia di finitura per controsoffitto Finish frame for false ceiling	.2, .3, .AL
L	686 Scatola 3-4-6-7 moduli Socket box 3-4-6-7 modules	
M	GTR60-1 Separatore in PVC Separator of PVC	
N	605-4 Supporto fino a 4 interruttori modulari Support til 4 modular switches	
O	BS80-04 Mostrina in plastica per 605-4 Plastic frame for 605-4	.2, .3, .AL
P	SP660 Scatola con aggancio a scatto per: 2 moduli standard italiano, 1 modulo standard tedesco, 1 modulo standard inglese Socket box with click mounting for: 2 modules italian standard 1 module german standard 1 module english standard	
	SP664 Scatola con aggancio a scatto per 4 moduli standard italiano Socket box with click mounting for 4 modules italian standard	
	SP664E Scatola con aggancio a scatto per 2 moduli standard inglese Socket box with click mounting for 2 modules english standard	
	SP667 Scatola con aggancio a scatto per 7 moduli standard italiano Socket box with click mounting for 7 modules italian standard	
Q	BMT65 Morsetto di terra Ground terminal	

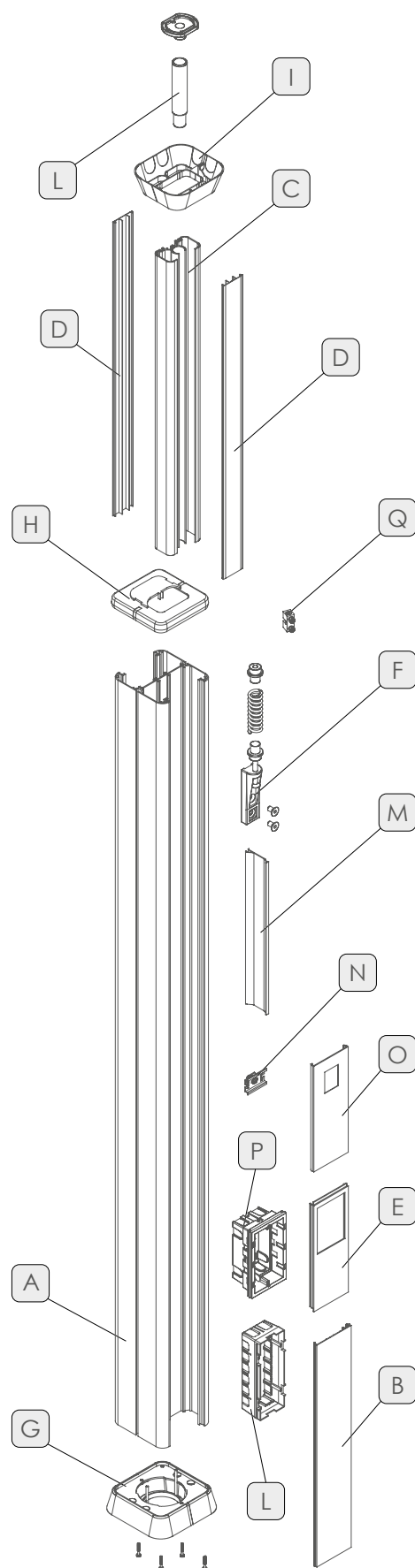

*Per ulteriori info tecniche vedi pagine 128/131

*For further technical info see pages 128/131

A Alluminio anodizzato
Anodized aluminium

A3 Alluminio verniciato bianco
White painted aluminium

VN Alluminio verniciato nero
Black painted aluminium

Colonne bifacciali movibili in alluminio

Movable bifacial office-poles in aluminium

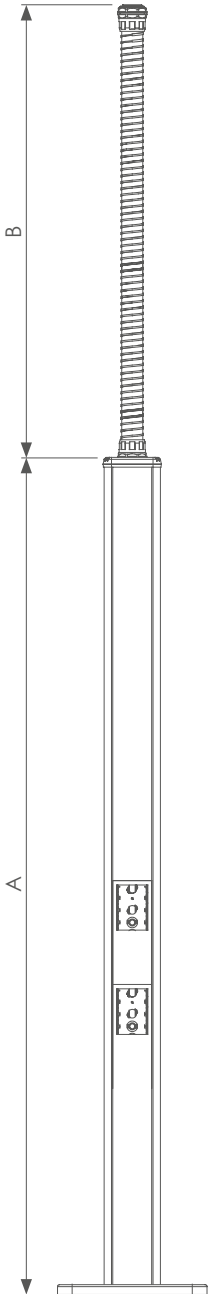

Articolo Item		Colore Color	Dotazione Equipment	A mm	B mm	
	129200A3	Alluminio bianco White Aluminium	<p>Altezza massima 430 cm</p> <p>1 colonna alluminio 2000 mm, 1 terminale superiore, 1 base a pavimento in acciaio verniciato nero 15 Kg, 1 guaina flessibile da Ø40 mm, 1 raccordo guaina/soffitto 4 scatole 3, 4, 7 moduli, 4 mostrine 3, 4, 7 moduli, 1 morsetto di terra</p> <p>Alimentazione da controsoffitto</p> <p>Maximum height 430 cm</p> <p>1 aluminium column 2000 mm, 1 upper terminal, 1 floor base in black painted steel 15 Kg, 1 flexible sheath of Ø40 mm, 1 sheath/ceiling connection 4 boxes 3, 4, 7 modules, 4 frames 3, 4, 7 modules, 1 ground terminal</p> <p>False ceiling power supply</p>	2000	2500	
	129200VN	Alluminio Nero Black Aluminium				
	129200AA	Alluminio anodizzato Anodized Aluminium				

Componenti singoli per la personalizzazione Single components for the customization

Articolo Item	Descrizione Description	Colori Colours
A	BU120115 Profilo colonna, barre da 6 metri Office-pole profile, 6 meter bars	A, A3, VN
B	BO80 Coperchio, barra fino 4 m Cover, bar of 4 meters	.2,.3,A,A3,VN
C	GS40 Guaina spiralata Ø40 mm Spiraled sheath Ø40 mm	Grigio Grey
	GS40N Guaina spiralata Ø40 mm Spiraled sheath Ø40 mm	Nero Black
D	RGS40M50 Raccordo M50 per guaina Ø40 mm Joint M50 for sheath Ø40 mm	Grigio Grey
	RGS40M50N Raccordo M50 per guaina Ø40 mm Joint M50 for sheath Ø40 mm	Nero Black
E	BS80-53 Mostrina in plastica 3, 4, 7 moduli Plastic frame 3, 4, 7 modules	.2, .3, .AL
	BS80-53 Mostrina in alluminio 3 moduli Aluminium frame 3 modules	A, A3, VN
	BS80-54 Mostrina in alluminio 4 moduli Aluminium frame 4 modules	A, A3, VN
	BS80-56 Mostrina in alluminio 7 moduli Aluminium frame 7 modules	A, A3, VN
F	BE115M Terminale superiore End piece	.2, .3, .AL
G	BASE-TWIN15 Base in acciaio verniciato peso 15 Kg Painted steel base weight 15 Kg	Nero Black
H	686 Scatola 3-4-6-7 moduli Socket box 3-4-6-7 modules	
I	GTR60-1 Separatore in plastica Separator of plastic	
L	605-4 Supporto fino a 4 interruttori modulari Support til 4 modular switches	
M	BS80-04 Mostrina in plastica per 605-4 Plastic frame for 605-4	.2, .3, .AL
N	SP660 Scatola con aggancio a scatto per: 2 moduli standard italiano, 1 modulo standard tedesco, 1 modulo standard inglese Socket box with click mounting for: 2 modules italian standard 1 module german standard 1 module english standard	
	SP664 Scatola con aggancio a scatto per 4 moduli standard italiano Socket box with click mounting for 4 modules italian standard	
	SP664E Scatola con aggancio a scatto per 2 moduli standard inglese Socket box with click mounting for 2 modules english standard	
	SP667 Scatola con aggancio a scatto per 7 moduli standard italiano Socket box with click mounting for 7 modules italian standard	
O	BMT65 Morsetto di terra Ground terminal	

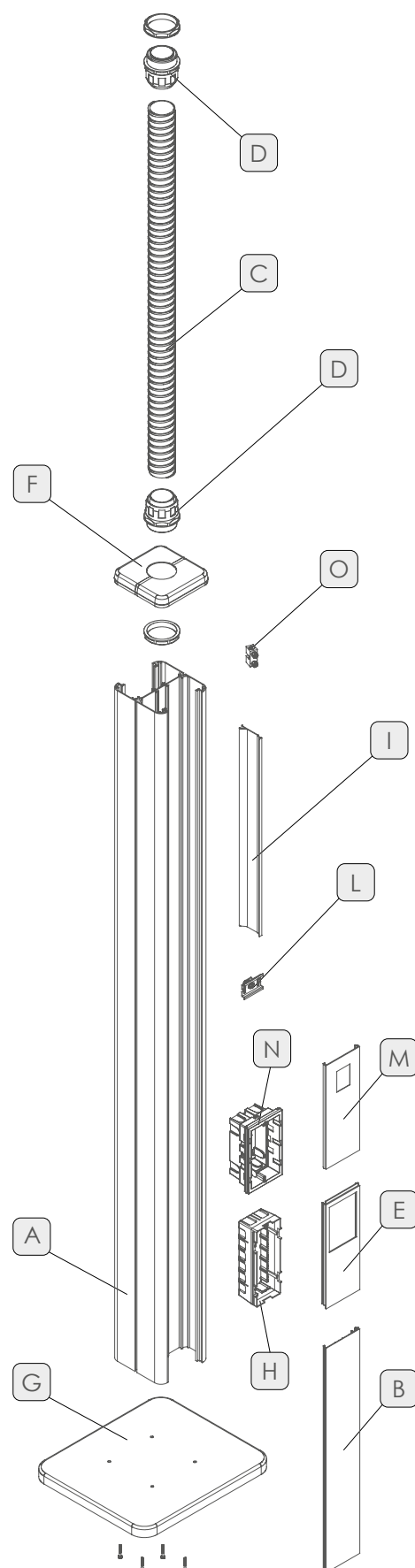

*Per ulteriori info tecniche vedi pagine 128/131

*For further technical info see pages 128/131

A Alluminio anodizzato
Anodized aluminium

A3 Alluminio verniciato bianco
White painted aluminium

VN Alluminio verniciato nero
Black painted aluminium

Sezione del profilo monofacciale e quantità conduttori inseribili al suo interno
Monofacial profile section and quantity of conductors that can be inserted

BU65115		Numero di conduttori tripolari inseribili nel profilo Number of tripolar cables insertable in the profile				
A mm	115	Area	3x1,5 mm ²	3x2,5 mm ²	3x4 mm ²	3x6 mm ²
B mm	80	D	14	11	9	8
C mm	65	E	14	11	9	8

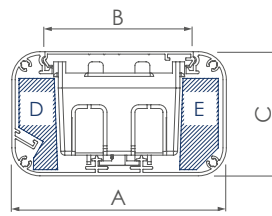

Sezione del profilo bifacciale e quantità conduttori inseribili al suo interno
Bifacial profile section and quantity of conductors that can be inserted

BU120115		Numero di conduttori tripolari inseribili nel profilo Number of tripolar cables insertable in the profile				
A mm	115	Area	3x1,5 mm ²	3x2,5 mm ²	3x4 mm ²	3x6 mm ²
B mm	80	D	14	11	10	9
C mm	118	E	14	10	9	7

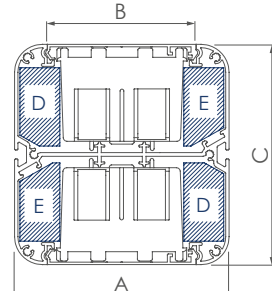

Sezione del profilo telescopico e quantità conduttori inseribili al suo interno
Telescopic profile section and quantity of conductors that can be inserted

BDS		Numero di conduttori tripolari inseribili nel profilo Number of tripolar cables insertable in the profile				
A mm	74	Area	3x1,5 mm ²	3x2,5 mm ²	3x4 mm ²	3x6 mm ²
B mm	41	D	8	6	6	5
C mm	41	E	8	6	6	5

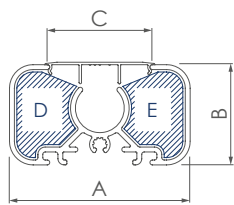

Base di fissaggio per profilo bifacciale
Fixing base for bifacial profile

Articolo Item	Colori Colours	A mm	B mm	C mm
BASE-TWIN	.2, .3, .AL	147	143	38

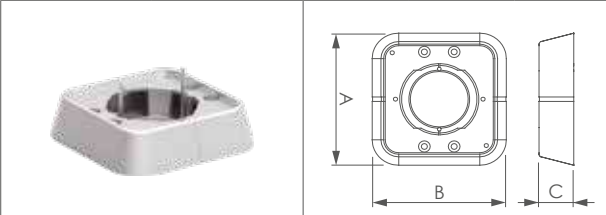

Base di fissaggio per profilo monofacciale
Fixing base for monofacial profile

Articolo Item	Colori Colours	A mm	B mm	C mm
BASE-TWIN1	.2, .3, .AL	166	100	30

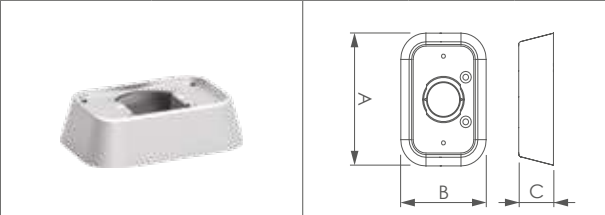

.2 Plastica nera
Black plastic

.3 Plastica bianca
White plastic

.AL Plastica verniciata alluminio
Aluminium painted plastic

Flangia di finitura per profilo telescopico Finish frame for telescopic profile

Articolo Item	Colori Colours	A mm	B mm	C mm
BF-BDS	.2, .3, .AL	122	118	40

Scatola 3-4-7 moduli, standard italiano Socket box 3-4-7 modules, italian standard

Articolo Item	A mm	B mm	C mm	D mm	E mm	F mm
686	175	50	68	83,5	108,5	100

Flangia di finitura per profilo colonna Finish frame for office-pole profile

Articolo Item	Colori Colours	A mm	B mm	C mm
BWA-TWIN1	.2, .3, .AL	166	100	30
BWA-TWIN	.2, .3, .AL	147	143	38

Mostrine in alluminio per scatole 3, 4, 7 moduli Aluminium frames for 3, 4, 7 module boxes

Articolo Item	Colori Colours	Moduli Module	A mm	B mm	C mm	D mm
BS80-53	A, A3, VN	3	210	80	83,5	64
BS80-54		4	210	80	108,5	64
BS80-56		7	210	80	100	64

Morsetto di terra Earthing clamp

Articolo Item	A mm	B mm	C mm	ØD mm
BMT65	20	8,5	15,5	6

Mostrina in plastica per scatole 3, 4, 7 moduli Plastic frame for 3,4,7 module boxes

Articolo Item	Colori Colours	A mm	B mm	C mm	D mm
BS80-53	.2, .3, .AL	210	80	83,5 Pretranciata Precutted 108,5 - 100	64

Supporto per 2 apparecchi modulari da 17,5 mm Support for 2 modular switches of 17,5 mm

Articolo Item	A mm	B mm	C mm
605-4	50	7,5	35

Mostrina per 2 modulari da 17,5 mm Frame for 2 modular switches of 17,5 mm

Articolo Item	Colori Colours	A mm	B mm	C mm	D mm
BS80-04	.2, .3, A	210	80	45	35

A Alluminio anodizzato
Anodized aluminium

A3 Alluminio verniciato bianco
White painted aluminium

VN Alluminio verniciato nero
Black painted aluminium



Scatola con aggancio a scatto
Socket box with click mounting

Articolo Item	Moduli Modules	A mm	B mm	C mm	D mm
SP660	2 standard italiano o 1 fedesco o 1 inglese 2 Italian standard or 1 German or 1 English	70	53	80	60

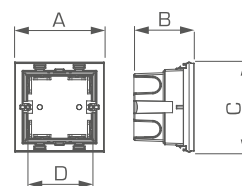

SP664	4 standard italiano 4 Italian standard	132	53	80	108,5
SP664E	2 standard inglese 2 English standard	144	53	80	120,6
SP667	7 standard italiano 7 Italian standard	184	53	80	100

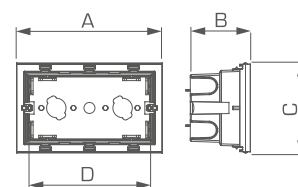

Le nuove scatole porta apparecchi SP si montano a scatto sui bordi dei canali. Il coperchio si accosta alla scatola ed il telaio e la placca della serie civile coprono la giunzione. Questo permette:

1. Un risultato estetico migliore senza interruzioni del coperchio
2. Una flessibilità maggiore nel posizionamento della scatola
3. Un risparmio economico in quanto non si usano le mostrine

The new SP socket boxes snap onto the edges of the trunking. The cover approaches the box and the frame and the plate of the civil series cover the junction. This allows:

1. A better aesthetic result without interruptions of the cover
2. Greater flexibility in the positioning of the box
3. An economic saving as the frame are not used

Nuova scatola con fissaggio a scatto
su profili in alluminio di torrette e colonne
New socket box with click mounting on
aluminium profiles for turrets and office-poles

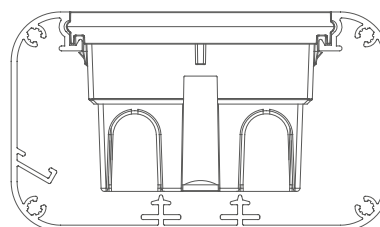



Basi colonne

Le basi delle colonne monofacciali e bifacciali hanno una pretranciatura interna per l'installazione di canali soprapavimento CAMBER KP1873, KP1250 e KP1031.

Office-pole base

The bases of the monofacial and bifacial office-poles have an internal pre-cut for the installation of overfloor trunkings CAMBER KP1873, KP1250 and KP1031.

Proteggi cavo

Per evitare il danneggiamento o il taglio dei cavi durante l'inserimento all'interno del profilo telescopico, applicare il proteggi cavo di plastica in dotazione.

Cable protector

To avoid damaging or cutting the cables during insertion inside the telescopic profile, apply the supplied plastic cable protector.



Macchinetta di tensionamento

Applicare la base della macchinetta all'interno delle guide presenti sul fondo del profilo colonna:

- 1) Portare in posizione la macchinetta e bloccarla provvisoriamente con la vite sul fondo;
- 2) Inserire la molla e la barra di spinta, portare in battuta al soffitto e serrare definitivamente le viti orizzontali;
- 3) Mettere in tensione la barra di spinta al soffitto avvitando la vite verticale.

Tension machine

Apply the base of the machine inside the guides on the bottom of the column profile:

- 1) Bring the machine into position and temporarily lock it with the screw on the bottom;
- 2) Insert the spring and the push bar, bring it up to the ceiling and tighten the horizontal screws definitively;
- 3) Tension the push bar to the ceiling by tightening the vertical screw.

TRIWER-UP

PERSONALIZZABILE
CUSTOMIZABLE

Torrette multipresa in ALLUMINIO

Multisocket turrets of ALUMINIUM





Caratteristiche Tecniche

- Profilo e coperchio in Alluminio
- Accessori in Abs
- Apertura con attrezzo
- Resistenza all'urto IK08 (5J)
- Grado di protezione IP40
- Tensione nominale 750V

Technical Features

- Aluminium profile and cover
- Abs accessories
- Opening only with tool
- Mechanical protection IK 08 (5J)
- Protection degree IP40
- Nominal voltage 750V

Riferimenti a Norme

- Conforme alla norma CEI EN 50085-2-2
- Conforme alla norma CEI EN 50085-2-4
- Conforme alla Direttiva RoHS 2015/863/EU
- Conforme alla Direttiva B.T. 2009/95/CE

Norms Reference

- Complies with standard CEI EN 50085-2-2
- Complies with standard CEI EN 50085-2-4
- Compliant with RoHS Directive 2015/863/EU
- The system complied to L.V.D. 2009/95/CE

Marchi e Certificazioni

- Marcatura CE

Marks and Certifications

- CE marking

Colori disponibili



- Alluminio verniciato Bianco
- Alluminio verniciato Nero
- Alluminio spazzolato e anodizzato naturale

Available colours

- White painted Aluminium
- Black painted Aluminium
- Brushed and natural anodized Aluminium

Torrette triangolari elettrificabili, in alluminio
Wiring triangular turrets, of aluminium



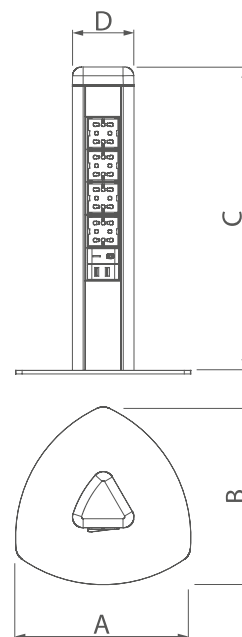

Articolo Item		Descrizione Description	Aggancio Coupling	A mm	B mm	C mm	D mm
	MTR50NA	Torretta alluminio nero, terminale plastica nera, mostrine e cornici in plastica trasparente per eventuale installazione LED, base in acciaio nero (vedere pagina 138)	10 moduli 10 modules BTicino LivingLight	245	250	430	85
	MTA50NA	Black aluminium turret, black plastic terminal, transparent plastic frames for LED light, black steel base (see page 138)	10 moduli 10 modules AVE 44				
	MTR50A3	Torretta alluminio bianco, terminale plastica bianca, mostrine e cornici in plastica trasparente per eventuale installazione LED, base in acciaio bianco (vedere pagina 138)	10 moduli 10 modules BTicino LivingLight	245	250	430	85
	MTA50A3	White aluminium turret, white plastic terminal, transparent plastic frames for LED light, white steel base (see page 138)	10 moduli 10 modules AVE 44				
	MTR50VN	Torretta alluminio anodizzato naturale, terminale plastica nera, mostrine e cornici in plastica trasparente per eventuale installazione LED, base in acciaio nero (vedere pagina 138)	10 moduli 10 modules BTicino LivingLight	245	250	430	85
	MTA50VN	Natural anodized aluminium turret, black plastic terminal, transparent plastic frames for LED light, black steel base (see page 138)	10 moduli 10 modules AVE 44				



Su richiesta sono disponibili moduli con dimensioni e configurazioni personalizzate

Torrette triangolari elettrificate, in alluminio Electrified triangular turrets, of aluminium

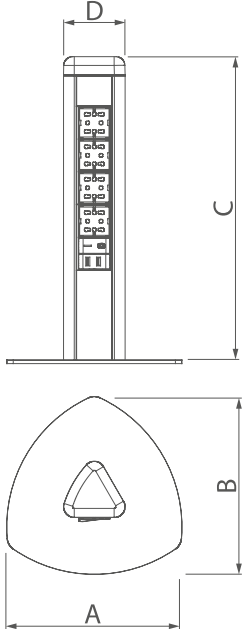

Articolo Item	Descrizione Description	A mm	B mm	C mm	D mm
	<p>MTR50-SU.NA</p> <p>Torretta in alluminio verniciato NERO, terminale plastica nera, cornici plastica trasparente, base in acciaio verniciato nero. Cablata con 4 MULTI-prese (4 Schuko/8 bipasso) 2 prese di carica USB 2.4A e 1 interruttore 2P cavo di alimentazione lunghezza 1,5 metri</p> <p>BLACK painted aluminium turret, black plastic end piece, transparent plastic frames, black painted steel base Wired with 4 MULTI-sockets (4 Schuko/8 bipasso) 2 USB sockets 2.4A and 1 switch 2P power cable length 1,5 meters</p>	245	250	430	85
	<p>MTR50-SU.A3</p> <p>Torretta in alluminio verniciato BIANCO, terminale plastica bianca, cornici plastica trasparente, base in acciaio verniciato bianco. Cablata con 4 MULTI-prese (4 Schuko/8 bipasso) 2 prese di carica USB 2.4A e 1 interruttore 2P cavo di alimentazione lunghezza 1,5 metri</p> <p>WHITE painted aluminium turret, white plastic end piece, transparent plastic frames, white painted steel base. Wired with 4 MULTI-sockets (4 Schuko/8 bipasso) 2 USB sockets 2.4A and 1 switch 2P power cable length 1,5 meters</p>				
	<p>MTR50-SU.VN</p> <p>Torretta in ALLUMINIO anodizzato naturale, terminale plastica nera, cornici plastica trasparente, base in acciaio verniciato nero. Cablata con 4 MULTI-prese (4 Schuko/8 bipasso) 2 prese di carica USB 2.4A e 1 interruttore 2P cavo di alimentazione lunghezza 1,5 metri</p> <p>Natural anodized ALUMINIUM turret, black plastic end piece, transparent plastic frames, black steel base. Wired with 4 MULTI-sockets (4 Schuko/8 bipasso) 2 USB sockets 2.4A and 1 switch 2P power cable length 1,5 meters</p>				

On request are available modules with different dimensions and personalized layouts

Componenti singoli per la personalizzazione Single components for the customization

Articolo Item	Descrizione Description	Colori Colours
A	MWR9090 Profilo base in alluminio in barre da 6 metri Aluminium base profile in 6 meter bars	AS, 3S, NS
B	MW45 Profilo coperchio alluminio in barre da 4 metri Cover for aluminium profile in bars of 4 meters	AS, 3S, NS
C	MTE Terminali superiore End cap	.2, .3, .2T, .3T, .AT
D	ML4 Mostrina autoportante 4 posti Bt Living Light Self-supporting frame 4 modules Bt Living Light	.2, .3, .T
	MA4 Mostrina autoportante 4 posti AVE 44 Self-supporting frame 4 modules AVE 44	
E	ML6 Mostrina autoportante 6 posti Bt Living Light Self-supporting frame 6 modules Bt Living Light	
	MA6 Mostrina autoportante 6 posti AVE 44 Self-supporting frame 6 modules AVE 44	
F	BMT65 Morsetto di terra Ground terminal	
G	MBTRIWER Base in acciaio verniciata Base in painted steel	3S, NS

.2	Plastica nera Black plastic
.3	Plastica bianca White plastic
.AL	Plastica verniciata alluminio Aluminium painted plastic
AS	Alluminio anodizzato Anodized aluminium
3S	Alluminio verniciato bianco White painted aluminium
NS	Alluminio verniciato nero Black painted aluminium
.2T	Plastica trasparente e nera Transparent and black plastic
.3T	Plastica trasparente e bianca Transparent and white plastic
.AT	Plastica trasparente e alluminio Transparent and aluminium plastic

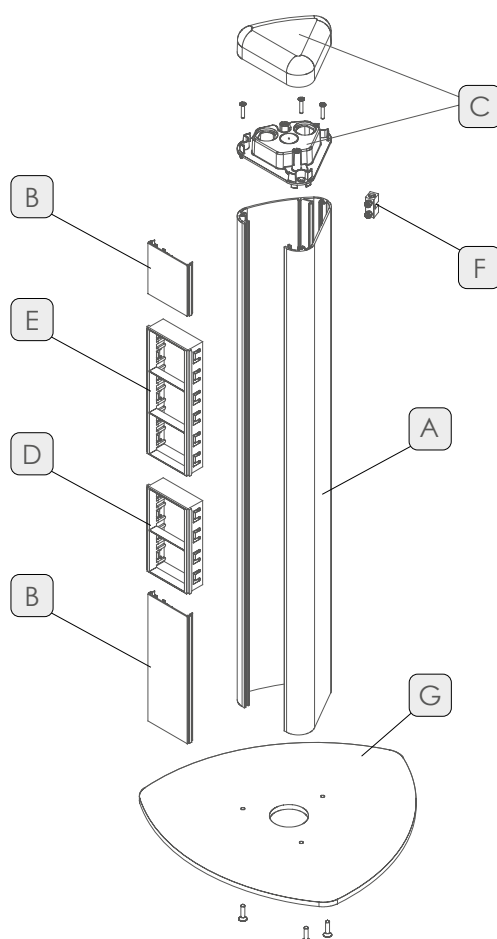

Mostrina autoportante 4 moduli BTicino Living Light Self-supporting frame 4 modules BTicino Living Light

Articolo Item		A mm	B mm	C mm
ML4.3	Bianco White	20,4	92,5	54
ML4.2	Nero Black			
ML4.T	Trasparente Transparent			

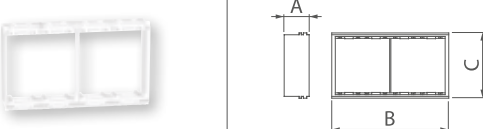

Mostrina autoportante 6 moduli BTicino Living Light Self-supporting frame 6 modules BTicino Living Light

Articolo Item		A mm	B mm	C mm
ML6.3	Bianco White	20,4	137,5	54
ML6.2	Nero Black			
ML6.T	Trasparente Transparent			

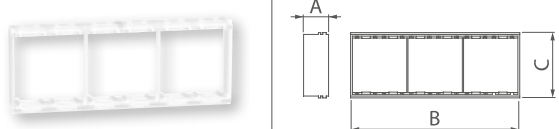

Mostrina autoportante 4 moduli Ave 44 Self-supporting frame 4 modules Ave 44

Articolo Item		A mm	B mm	C mm
MA4.3	Bianco White	19	92,5	54
MA4.2	Nero Black			
MA4.T	Trasparente Transparent			

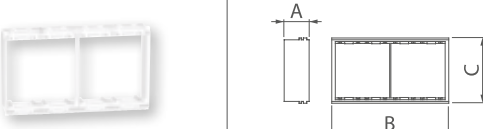

Mostrina autoportante 6 moduli Ave 44 Self-supporting frame 6 modules Ave 44

Articolo Item		A mm	B mm	C mm
MA6.3	Bianco White	19	137,5	54
MA6.2	Nero Black			
MA6.T	Trasparente Transparent			

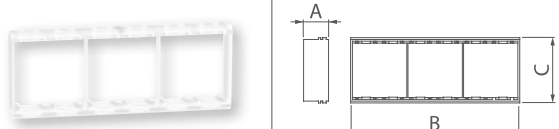

Mostrina autoportante 2 moduli 45x45 Self-supporting frame 2 modules 45x45

Articolo Item		A mm	B mm	C mm
MR4.3	Bianco White	19	92,5	54
MR4.2	Nero Black			
MR4.T	Trasparente Transparent			

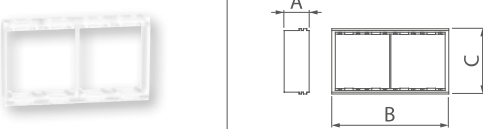

Mostrina autoportante 3 moduli 45x45 Self-supporting frame 3 modules 45x45

Articolo Item		A mm	B mm	C mm
MR6.3	Bianco White	19	137,5	54
MR6.2	Nero Black			
MR6.T	Trasparente Transparent			

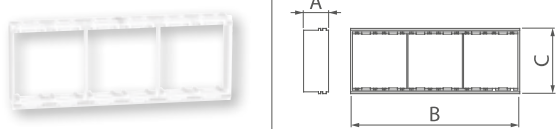

Terminali per profilo triangolare Triangular profile end piece

Articolo Item		A mm	B mm	C mm
MTE.3	Bianco White	27	86	79
MTE.2	Nero Black			
MTE.3T	Bianco/trasparente White/transparent			
MTE.2T	Nero/trasparente Black/ transparent			
MTE.AT	Alluminio/trasparente Aluminium/transparent			



Morsetto di terra Earthing clamp

Articolo Item	A mm	B mm	C mm	ØD mm
BMT65	20	8,5	15,5	6

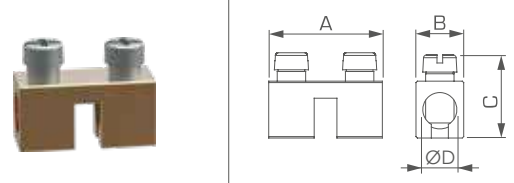

Base per torretta Turret base

Articolo Item	Colore Colour	A mm	B mm	C mm	ØD mm
MBTRIWER.V3M	Bianco White	245	250	5	35
MBTRIWER.VNM	Nero Black				

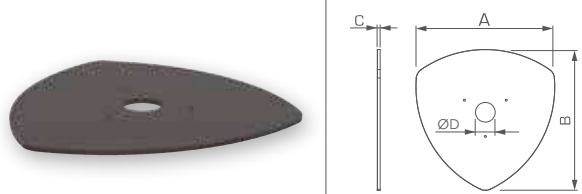

Kit LED per illuminazione interna torrette LED kit for internal illumination turrets

Articolo Item	Descrizione Description
MTLED	Striscia LED lunghezza 110 mm Led strip length 110 mm
MTRLED	Striscia LED lunghezza 250 mm Led strip length 250 mm
<ul style="list-style-type: none"> • Dimensione driver 55x30x30 mm; • La striscia LED è dotata di biadesivo; • Per illuminazione LED utilizzare le mostrine trasparenti (.T) e i terminali (.T) • Driver dimension 55x30x30 mm; • The LED strip is equipped with adhesive; • For LED lighting use the transparent frames (.T) and end piece (.T) 	

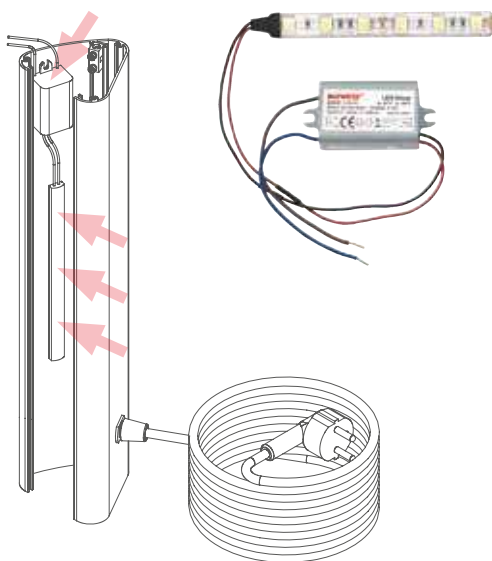



Pressacavo trasparente con controdado Transparent cable gland with nut

Articolo Item	Descrizione Description
MSTR	
<p>Per cavi da Ø 4,8 a Ø 6,8 mm, foro per fissaggio Ø 13 mm For cables from Ø 4.8 to Ø 6.8 mm, hole for fixing Ø 13 mm</p>	

Pressacavo in Nylon con controdado Nylon cable gland with nut

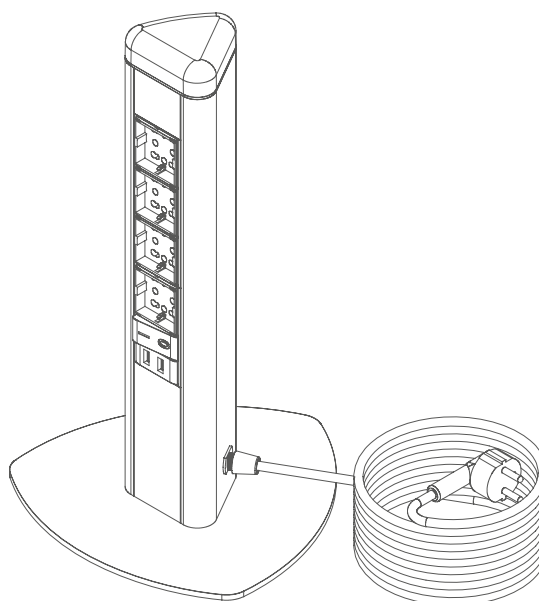
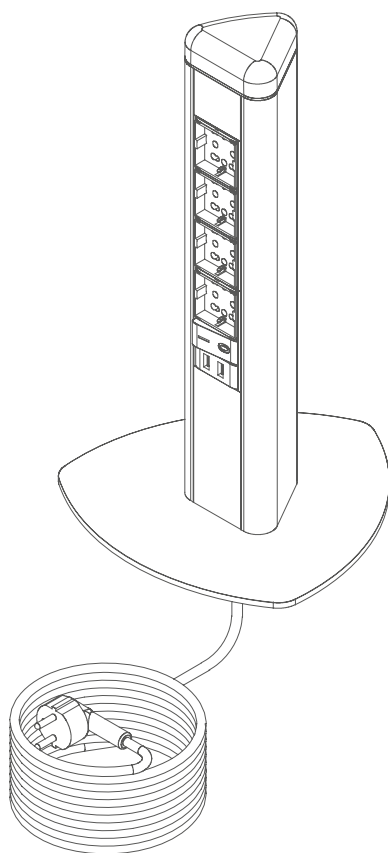
Articolo Item	Colore Colour	Descrizione Description
MP1601	Grigio chiaro Light grey	
MP1602	Nero Black	
<p>Per cavi da Ø 5 a Ø 10 mm, filettatura M16, fornito con controdado, foro per fissaggio Ø 16 mm For cables from Ø 5 to Ø 10 mm, thread M16, supplied with nut, hole for fixing Ø 16 mm</p>		



L'alimentazione delle torrette TRIWER-UP può essere realizzata da sottopavimento, utilizzando il foro sulla base d'acciaio, o tramite un pressacavo che offriamo in 2 versioni: in policarbonato trasparente o in Nylon con spirale proteggi cavo.

Praticare un foro adatto sul profilo in alluminio per l'inserimento del pressacavo scelto.

The power supply of the TRIWER-UP turrets can be made from an underfloor, using the hole in the steel base, or through a cable gland that we offer in 2 versions: in transparent polycarbonate or in Nylon with cable protecting spiral.

Drill a suitable hole on the aluminium profile for inserting the chosen cable gland.

TRIWER

PERSONALIZZABILE
CUSTOMIZABLE

Moduli multipresa in ALLUMINIO

Multisocket module of ALUMINIUM





Caratteristiche Tecniche

- Profilo e coperchio in Alluminio
- Accessori in Abs
- Apertura con attrezzo
- Resistenza all'urto IK08 (5J)
- Grado di protezione IP40
- Tensione nominale 750V

Technical Features

- Aluminium profile and cover
- Abs accessories
- Opening only with tool
- Mechanical protection IK 08 (5J)
- Protection degree IP40
- Nominal voltage 750V

Riferimenti a Norme

- Conforme alla norma CEI EN 50085-2-1
- Conforme alla Direttiva RoHS 2015/863/EU
- Conforme alla Direttiva B.T. 2009/95/CE

Norms Reference

- Complies with standard CEI EN 50085-2-1
- Compliant with RoHS Directive 2015/863/EU
- The system complied to L.V.D. 2009/95/CE

Marchi e Certificazioni

- Marcatura CE

Marks and Certifications

- CE marking

Colori disponibili

- Alluminio verniciato Bianco
- Alluminio verniciato Nero
- Alluminio spazzolato e anodizzato naturale

Available colours

- White painted Aluminium
- Black painted Aluminium
- Brushed and natural anodized Aluminium

Moduli triangolari elettrificabili in Alluminio
Triangular electrifiable modules of Aluminium



Articolo Item		Descrizione Description	Aggancio Coupling	A mm	B mm	C mm	Dimensioni Dimensions
	MT102AN	Alluminio nero, terminali nero, mostrina trasparente	4 moduli 4 modules BTicino LivingLight	80	85	145	
	MA102AN		4 moduli 4 modules AVE 44				
	MT103AN	Black aluminium, black end pieces, transparent frames	6 moduli 6 modules BTicino LivingLight	80	85	190	
	MA103AN		6 moduli 6 modules AVE 44				
	MT102NA	Alluminio nero, terminali nero, mostrina nero	4 moduli 4 modules BTicino LivingLight	80	85	145	
	MA102NA		4 moduli 4 modules AVE 44				
	MT103NA	Black aluminium, black end pieces, black frames	6 moduli 6 modules BTicino LivingLight	80	85	190	
	MA103NA		6 moduli 6 modules AVE 44				
	MT102VN	Alluminio anodizzato, terminali nero, mostrina nero	4 moduli 4 modules BTicino LivingLight	80	85	145	
	MA102VN		4 moduli 4 modules AVE 44				
	MT103VN	Anodized aluminium, black end pieces, black frames	6 moduli 6 modules BTicino LivingLight	80	85	190	
	MA103VN		6 moduli 6 modules AVE 44				

Su richiesta sono disponibili moduli con dimensioni e configurazioni personalizzate

Moduli triangolari elettrificabili in Alluminio Triangular electrifiable modules in Aluminium







Articolo Item		Descrizione Description	Aggancio Coupling	A mm	B mm	C mm	Dimensioni Dimensions
	MT102T3	Alluminio bianco, terminali bianco, mostrina trasparente	4 moduli 4 modules BTicino LivingLight	80	85	145	
	MA102T3		4 moduli 4 modules AVE 44				
	MT103T3	White aluminium, white end pieces, transparent frames	6 moduli 6 modules BTicino LivingLight	80	85	190	
	MA103T3		6 moduli 6 modules AVE 44				
	MT102A3	Alluminio bianco, terminali bianco, mostrina bianco	4 moduli 4 modules BTicino LivingLight	80	85	145	
	MA102A3		4 moduli 4 modules AVE 44				
	MT103A3	White aluminium, white end pieces, white frames	6 moduli 6 modules BTicino LivingLight	80	85	190	
	MA103A3		6 moduli 6 modules AVE 44				
	MT102AA	Alluminio anodizzato, terminali alluminio, mostrina trasparente	4 moduli 4 modules BTicino LivingLight	80	85	145	
	MA102AA		4 moduli 4 modules AVE 44				
	MT103AA	Anodized aluminium, aluminium end pieces, transparent frames	6 moduli 6 modules BTicino LivingLight	80	85	190	
	MA103AA		6 moduli 6 modules AVE 44				

On request are available modules with different dimensions and personalized layouts



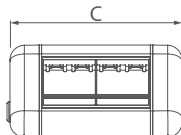

Moduli triangolari elettrificati in alluminio

Wired triangular modules of aluminium

Articolo Item		Descrizione Description	A mm	B mm	C mm
	MT102.4B.NA	Modulo alluminio nero, accessori plastica nera cablato con 2 multi-prese (2 Schuko/4 bipasso) cavo di alimentazione lunghezza 1,5 metri Black aluminium module, black plastic accessories wired with 2 multi-sockets (2 Schuko/4 bipasso) power cable length 1,5 meters	80	85	145
	MT102.4B.A3	Modulo alluminio bianco, accessori plastica bianca, cablato con 2 multi-prese (2 Schuko/4 bipasso) cavo di alimentazione lunghezza 1,5 metri White aluminium module, white plastic accessories wired with 2 multi-sockets (2 Schuko/4 bipasso) power cable length 1,5 meters			
	MT102.4B.VN	Modulo alluminio anodizzato, accessori plastica nera, cablato con 2 multi-prese (2 Schuko/4 bipasso) cavo di alimentazione lunghezza 1,5 metri Anodized aluminium module, black plastic accessories wired with 2 multi-sockets (2 Schuko/4 bipasso) power cable length 1,5 meters			

Moduli triangolari elettrificati in alluminio

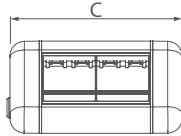



Wired triangular modules of aluminium

Articolo Item		Descrizione Description	A mm	B mm	C mm
	MT102.4S.NA	Modulo alluminio nero, accessori plastica nera cablato con 1 multi-presa e 2 prese di carica USB 2.4A cavo di alimentazione lunghezza 1,5 metri Black aluminium module, black plastic accessories wired with 1 multi-socket and 2 USB sockets 2.4A power cable length 1,5 meters	80	85	145
	MT102.4S.A3	Modulo alluminio bianco, accessori plastica bianca cablato con 1 multi-presa e 2 prese di carica USB 2.4A cavo di alimentazione lunghezza 1,5 metri White aluminium module, white plastic accessories wired with 1 multi-socket and 2 USB sockets 2.4A power cable length 1,5 meters			
	MT102.4S.VN	Modulo alluminio anodizzato, accessori plastica nera cablato con 1 multi-presa e 2 prese di carica USB 2.4A cavo di alimentazione lunghezza 1,5 metri Anodized aluminium module, black plastic accessories wired with 1 multi-socket and 2 USB sockets 2.4A power cable length 1,5 meters			

Su richiesta sono disponibili moduli con dimensioni e configurazioni personalizzate

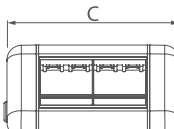
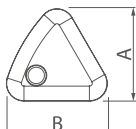

Moduli triangolari elettrificati in alluminio Wired triangular modules of aluminium



Articolo Item	Descrizione Description	A mm	B mm	C mm
	MT103.4S.NA Modulo alluminio nero, accessori plastica nera cablato con 2 MULTI-prese e 2 prese di carica USB 2.4A cavo di alimentazione lunghezza 1,5 metri Black aluminium module, black plastic accessories wired with 2 multi-sockets and 2 USB sockets 2.4A power cable length 1,5 meters	80	85	190
	MT103.4S.A3 Modulo alluminio bianco, accessori plastica bianca cablato con 2 multi-prese e 2 prese di carica USB 2.4A cavo di alimentazione lunghezza 1,5 metri White aluminium module, white plastic accessories wired with 2 multi-sockets and 2 USB sockets 2.4A power cable length 1,5 meters	 		
	MT103.4S.VN Modulo alluminio anodizzato, accessori plastica nera cablato con 2 multi-prese e 2 prese di carica USB 2.4A cavo di alimentazione lunghezza 1,5 metri Anodized aluminium module, black plastic accessories wired with 2 multi-sockets and 2 USB sockets 2.4A power cable length 1,5 meters			

Moduli triangolari elettrificati in alluminio Wired triangular modules, of aluminium

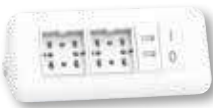
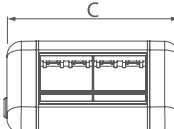
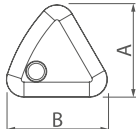

Articolo Item	Descrizione Description	A mm	B mm	C mm
	MT103.SU.NA Modulo nero, accessori plastica nera cablato con 2 multi-prese, 2 prese di carica USB 2.4A e 1 interruttore 2P, cavo di alimentazione lunghezza 1,5 metri Black aluminium module, black plastic accessories wired with 2 multi-sockets, 2 USB sockets 2.4A and 1 switch 2P, power cable length 1,5 meters	80	85	190
	MT103.SU.A3 Modulo bianco, accessori plastica bianca cablato con 2 multi-prese, 2 prese di carica USB 2.4A e 1 interruttore 2P, cavo alimentazione lunghezza 1,5 metri White aluminium module, white plastic accessories wired with 2 multi-sockets, 2 USB sockets 2.4A and 1 switch 2P, power cable length 1,5 meters	 		
	MT103.SU.VN Modulo alluminio, accessori plastica nera cablato con 2 multi-prese, 2 prese di carica USB 2.4A e 1 interruttore 2P, cavo di alimentazione lunghezza 1,5 metri Anodized ALUMINIUM module, black plastic accessories wired with 2 MULTI-sockets, 2 USB sockets 2.4A and 1 switch 2P, power cable length 1,5 meters			

On request are available modules with different dimensions and personalized layouts

Componenti singoli per la personalizzazione Single components for the customization

Articolo Item	Descrizione Description	Colori Colours
A	MW9090 Profilo base in alluminio in barre da 6 metri Aluminium base profile in 6 meter bars	AS, 3S, NS
B	MW45 Profilo coperchio alluminio in barre da 4 metri Cover for aluminium profile in bars of 4 meters	AS, 3S, NS
C	MTE Coppia di terminali Couple of end pieces	.2, .3, .2T, .3T, .AT
D	ML4 Mostrina autoportante 4 posti Bt Living Light Self-supporting frame 4 modules Bt Living Light	.2, .3, .T
	MA4 Mostrina autoportante 4 posti AVE 44 Self-supporting frame 4 modules AVE 44	
E	ML6 Mostrina autoportante 6 posti Bt Living Light Self-supporting frame 6 modules Bt Living Light	
	MA6 Mostrina autoportante 6 posti AVE 44 Self-supporting frame 6 modules AVE 44	
F	BMT65 Morsetto di terra Ground terminal	

.2	Plastica nera Black plastic
.3	Plastica bianca White plastic
.AL	Plastica verniciata alluminio Aluminium painted plastic
AS	Alluminio anodizzato Anodized aluminium
3S	Alluminio verniciato bianco White painted aluminium
NS	Alluminio verniciato nero Black painted aluminium
.2T	Plastica trasparente e nera Transparent and black plastic
.3T	Plastica trasparente e bianca Transparent and white plastic
.AT	Plastica trasparente e alluminio Transparent and aluminium plastic

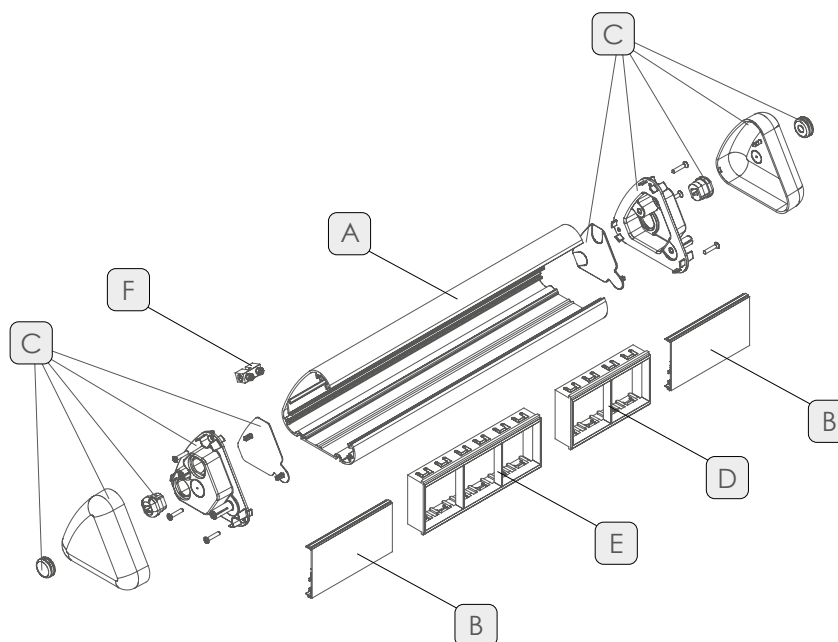

Sezione del profilo e quantità conduttori inseribili al suo interno Section and quantity of conductors that can be inserted

MW9090		Numero di conduttori tripolari inseribili nel profilo Number of tripolar cables insertable in the profile					
A mm	80	Area	3x1,5 mm ²	3x2,5 mm ²	3x4 mm ²	3x6 mm ²	
B mm	85	C	4	3	3	2	

Mostrina autoportante 4 moduli BTicino Living Light Self-supporting frame 4 modules BTicino Living Light

Articolo Item		A mm	B mm	C mm
ML4.3	Bianco White	20,4	92,5	54
ML4.2	Nero Black			
ML4.T	Trasparente Transparent			

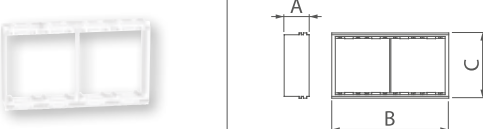

Mostrina autoportante 6 moduli BTicino Living Light Self-supporting frame 6 modules BTicino Living Light

Articolo Item		A mm	B mm	C mm
ML6.3	Bianco White	20,4	137,5	54
ML6.2	Nero Black			
ML6.T	Trasparente Transparent			

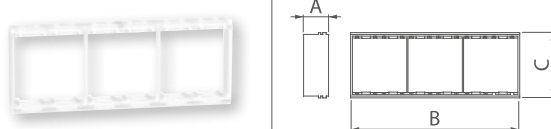

Mostrina autoportante 4 moduli Ave 44 Self-supporting frame 4 modules Ave 44

Articolo Item		A mm	B mm	C mm
MA4.3	Bianco White	19	92,5	54
MA4.2	Nero Black			
MA4.T	Trasparente Transparent			

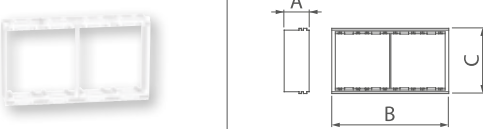

Mostrina autoportante 6 moduli Ave 44 Self-supporting frame 6 modules Ave 44

Articolo Item		A mm	B mm	C mm
MA6.3	Bianco White	19	137,5	54
MA6.2	Nero Black			
MA6.T	Trasparente Transparent			

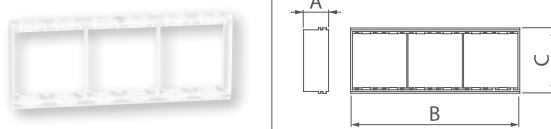

Mostrina autoportante 2 moduli 45x45 Self-supporting frame 2 modules 45x45

Articolo Item		A mm	B mm	C mm
MR4.3	Bianco White	19	92,5	54
MR4.2	Nero Black			
MR4.T	Trasparente Transparent			

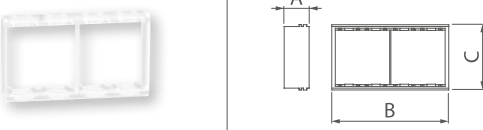

Mostrina autoportante 3 moduli 45x45 Self-supporting frame 3 modules 45x45

Articolo Item		A mm	B mm	C mm
MR6.3	Bianco White	19	137,5	54
MR6.2	Nero Black			
MR6.T	Trasparente Transparent			

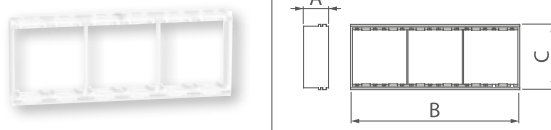

Corda antiscivolo in gomma
Non-slip rubber rope

Articolo Item	Descrizione Description
CTRIWER	Rotolo da 10 metri da inserire nella base dei profili MW9090 Roll of 10 meters to insert in the profiles MW9090
	

Nastro adesivo ad alta tenuta
High-strength adhesive tape

Articolo Item	Descrizione Description
MNB5	Rotolo da 5 metri per il fissaggio del modulo senza forare la scrivania Roll of 5 meters for fixing the module without drilling the desk
	

Supporto di fissaggio a morsetto per scrivania
Fixing support clamp for desk

Articolo Item	Colore Item		
MST.V3M	Bianco White		
MST.VNM	Nero Black		
Per il fissaggio dei moduli a scrivanie o tavoli senza forare il piano. For fixing the modules to desks or tables without drilling the top.			

Sistemi di fissaggio dei moduli TRIWER
Fixing systems for TRIWER modules

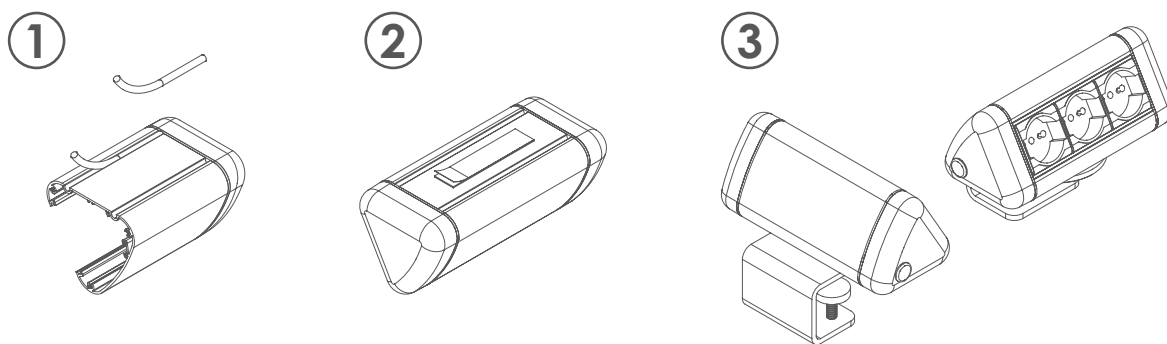

I moduli TRIWER possono essere appoggiati o fissati a scrivanie o postazioni di lavoro in 3 differenti modi:

1. Inserendo a pressione, sul fondo del modulo, la corda in gomma antiscivolo
2. Utilizzando il biadesivo ad alta tenuta
3. Fissando sul bordo del ripiano con il supporto a morsetto

TRIWER modules can be placed or fixed to desks or workstations in 3 different ways:

1. By pressing the non-slip rubber cord into the bottom of the module
2. Using the high-strength double-sided tape
3. Fixing on the edge of the shelf with the clamp holder

Terminali per profilo triangolare
Triangular profile end piece

Articolo Item		A mm	B mm	C mm
MTE.3	Bianco White	27	86	79
MTE.2	Nero Black			
MTE.3T	Bianco/trasparente White/transparent			
MTE.2T	Nero/trasparente Black/ transparent			
MTE.AT	Alluminio/trasparente Aluminium/transparent			

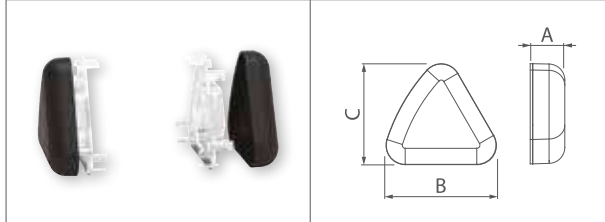

Morsetto di terra
Earthing clamp

Articolo Item	A mm	B mm	C mm	ØD mm
BMT65	20	8,5	15,5	6

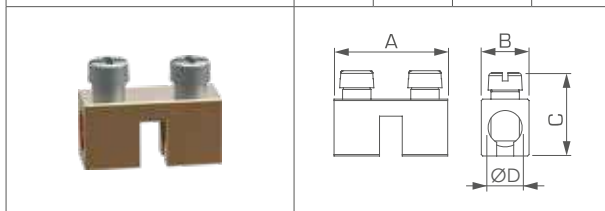

Kit LED per illuminazione interna torrette
LED kit for internal illumination turrets

Articolo Item	Descrizione Description
MTLED	Striscia LED lunghezza 110 mm Led strip length 110 mm
MTRLED	Striscia LED lunghezza 250 mm Led strip length 250 mm

- Dimensione driver 55x30x30 mm;
- La striscia LED è dotata di biadesivo;
- Per illuminazione LED utilizzare le mostrine trasparenti (.T) e i terminali (.T)
- Driver dimension 55x30x30 mm;
- The LED strip is equipped with adhesive;
- For LED lighting use the transparent frames (.T) and end piece (.T)

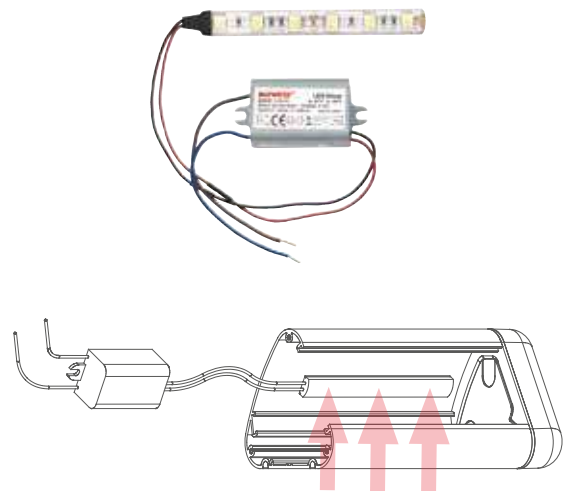

SKYLINE

PERSONALIZZABILE
CUSTOMIZABLE

Torrette multipresa in ALLUMINIO

Multisocket turrets of ALUMINIUM





Caratteristiche Tecniche

- Profilo e coperchio in Alluminio
- Accessori in Abs
- Apertura con attrezzo
- Resistenza all'urto IK08 (5J)
- Grado di protezione IP40
- Tensione nominale 750V

Technical Features

- Aluminium profile and cover
- Abs accessories
- Opening only with tool
- Mechanical protection IK 08 (5J)
- Protection degree IP40
- Nominal voltage 750V

Riferimenti a Norme

- Conforme alla norma CEI EN 50085-2-2
- Conforme alla norma CEI EN 50085-2-4
- Conforme alla Direttiva RoHS 2015/863/EU
- Conforme alla Direttiva B.T. 2009/95/CE

Norms Reference

- Complies with standard CEI EN 50085-2-2
- Complies with standard CEI EN 50085-2-4
- Compliant with RoHS Directive 2015/863/EU
- The system complied to L.V.D. 2009/95/CE

Marchi e Certificazioni

- Marcatura CE

Marks and Certifications

- CE marking

Colori disponibili



- Alluminio verniciato Bianco
- Alluminio verniciato Nero

Available colours

- White painted Aluminium
- Black painted Aluminium

Torrette a mezza luna elettrificabili in alluminio
Electrifiable half-moon turrets in aluminium



Articolo Item		Colore Color	Mostrina Frame	Descrizione Description	A mm	B mm	C mm
	MSL110.A3	Bianco White	BTicino Living Light	<p>Torretta in alluminio, per 10 moduli, terminale superiore in plastica, base in acciaio verniciato, alimentazione sotto-pavimento con separazione dati/energia</p> <p>Aluminium turret, for 10 modules, plastic terminal, painted steel base, under-floor power supply with data/energy separation</p>	220	300	120
	MSA110.A3		Ave 44				
	MSR110.A3		45x45 mm				
	MSL118.A3	Bianco White	BTicino Living Light	<p>Torretta in alluminio, per 20 moduli, terminale superiore in plastica, base in acciaio verniciato, alimentazione sotto-pavimento con separazione dati/energia</p> <p>Aluminium turret, for 20 modules, plastic terminal, painted steel base, under-floor power supply with data/energy separation</p>	220	440	120
	MSA118.A3		Ave 44				
	MSR118.A3		45x45 mm				
	MSL124.A3	Bianco White	BTicino Living Light	<p>Torretta in alluminio, per 30 moduli, terminale superiore in plastica, base in acciaio verniciato, alimentazione sotto-pavimento con separazione dati/energia</p> <p>Aluminium turret, for 30 modules, plastic terminal, painted steel base, under-floor power supply with data/energy separation</p>	220	580	120
	MSA124.A3		Ave 44				
	MSR124.A3		45x45 mm				

Su richiesta sono disponibili moduli con dimensioni e configurazioni personalizzate

Torrette a mezza luna elettrificabili in alluminio Electrifiable half-moon turrets in aluminium



Articolo Item		Colore Color	Mostrina Frame	Descrizione Description	A mm	B mm	C mm
	MSL110.N	Nero Black	BTicino Living Light	<p>Torretta in alluminio, per 10 moduli, terminale superiore in plastica, base in acciaio verniciato, alimentazione sotto-pavimento con separazione dati/energia</p> <p>Aluminium turret, for 10 modules, plastic terminal, painted steel base, under-floor power supply with data/energy separation</p>	220	300	120
	MSA110.N		Ave 44				
	MSR110.N		45x45 mm				
	MSL118.N	Nero Black	BTicino Living Light	<p>Torretta in alluminio, per 20 moduli, terminale superiore in plastica, base in acciaio verniciato, alimentazione sotto-pavimento con separazione dati/energia</p> <p>Aluminium turret, for 20 modules, plastic terminal, painted steel base, under-floor power supply with data/energy separation</p>	220	440	120
	MSA118.N		Ave 44				
	MSR118.N		45x45 mm				
	MSL124.N	Nero Black	BTicino Living Light	<p>Torretta in alluminio, per 30 moduli, terminale superiore in plastica, base in acciaio verniciato, alimentazione sotto-pavimento con separazione dati/energia</p> <p>Aluminium turret, for 30 modules, plastic terminal, painted steel base, under-floor power supply with data/energy separation</p>	220	580	120
	MSA124.N		Ave 44				
	MSR124.N		45x45 mm				

On request are available modules with different dimensions and personalized layouts

Componenti singoli per la personalizzazione Single components for the customization

Articolo Item	Descrizione Description	Colori Colors	
A	MI125 Profilo base in alluminio in barre da 6 metri Aluminium base profile in 6 meter bars	A3, N	
B	MW45 Profilo coperchio alluminio in barre da 4 metri Cover for aluminium profile in bars of 4 meters	A3, N	
C	MBSKY Base in acciaio verniciata Base in painted steel	A3, N	
D	ML4 Telaio autoportante 4 posti BT Living Light BT Living Light 4 modules self-supporting frame	.2, .3, .T	
	MA4 Telaio autoportante 4 posti Ave 44 Ave 44 4 modules self-supporting frame		
E	ML6 Telaio autoportante 6 posti BT Living Light BT Living Light 6 modules self-supporting frame		
	MA6 Telaio autoportante 6 posti Ave 44 Ave 44 6 modules self-supporting frame		
F	MTSKY Kit terminale, morsetto di terra, separatore, viti Terminal kit, ground terminal, separator, screws		.2, .3

.2	Plastica nera Black plastic
.3	Plastica bianca White plastic
.T	Plastica trasparente Transparent plastic
A3	Alluminio verniciato bianco White painted aluminium
N	Alluminio verniciato nero Black painted aluminium

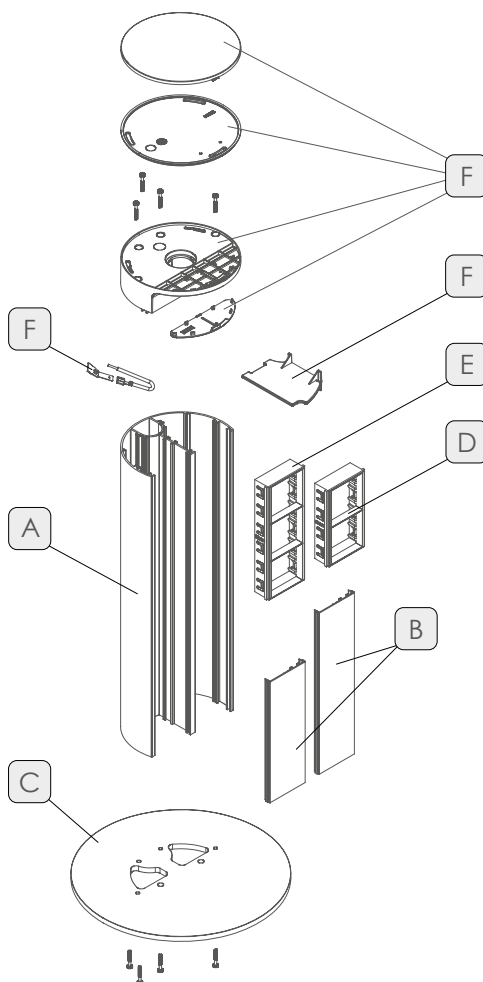

Mostrina autoportante 4 moduli BTicino Living Light Self-supporting frame 4 modules BTicino Living Light

Articolo Item		A mm	B mm	C mm
ML4.3	Bianco White	20,4	92,5	54
ML4.2	Nero Black			
ML4.T	Trasparente Transparent			

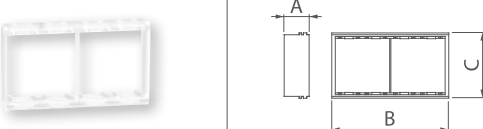

Mostrina autoportante 6 moduli BTicino Living Light Self-supporting frame 6 modules BTicino Living Light

Articolo Item		A mm	B mm	C mm
ML6.3	Bianco White	20,4	137,5	54
ML6.2	Nero Black			
ML6.T	Trasparente Transparent			

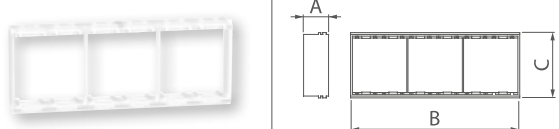

Mostrina autoportante 4 moduli Ave 44 Self-supporting frame 4 modules Ave 44

Articolo Item		A mm	B mm	C mm
MA4.3	Bianco White	19	92,5	54
MA4.2	Nero Black			
MA4.T	Trasparente Transparent			

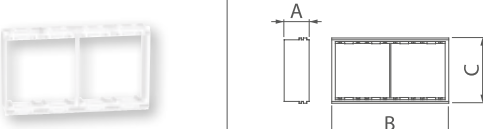

Mostrina autoportante 6 moduli Ave 44 Self-supporting frame 6 modules Ave 44

Articolo Item		A mm	B mm	C mm
MA6.3	Bianco White	19	137,5	54
MA6.2	Nero Black			
MA6.T	Trasparente Transparent			

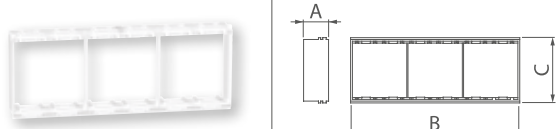

Mostrina autoportante 2 moduli 45x45 Self-supporting frame 2 modules 45x45

Articolo Item		A mm	B mm	C mm
MR4.3	Bianco White	19	92,5	54
MR4.2	Nero Black			
MR4.T	Trasparente Transparent			

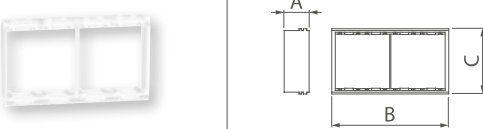

Mostrina autoportante 3 moduli 45x45 Self-supporting frame 3 modules 45x45

Articolo Item		A mm	B mm	C mm
MR6.3	Bianco White	19	137,5	54
MR6.2	Nero Black			
MR6.T	Trasparente Transparent			

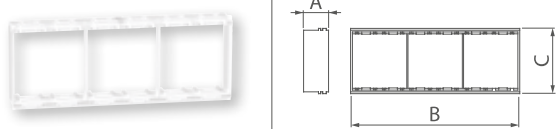

Terminale superiore in plastica
Plastic end cup

Articolo Item		A mm	B mm
MTSKY.3	Bianco White	120	36
MTSKY.2	Nero Black		

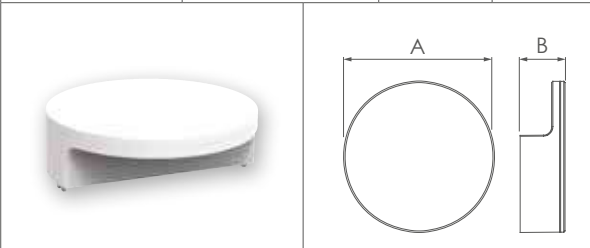

Base in acciaio
Steel base

Articolo Item	Colore Colour	A mm	B mm	C mm	D mm
MBSKY.A3	Verniciata bianca White painted	220	220	5	40
MBSKY.N	Verniciata nera Black painted				

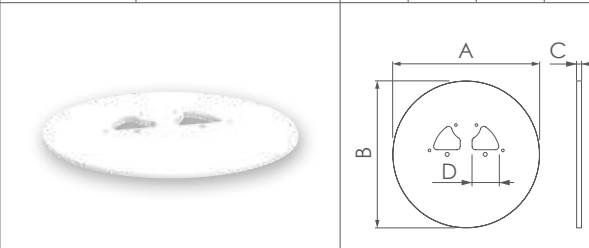

Pressacavo trasparente con controdado
Transparent cable gland with nut

Articolo Item	Descrizione Description
MSTR	

Per cavi da Ø 4,8 a Ø 6,8 mm,
foro per fissaggio Ø 13 mm
For cables from Ø 4.8 to Ø 6.8 mm,
hole for fixing Ø 13 mm

Pressacavo in Nylon con controdado
Nylon cable gland with nut

Articolo Item	Colore Colour	Descrizione Description
MP1601	Grigio chiaro Light grey	
MP1602	Nero Black	

Per cavi da Ø 5 a Ø 10 mm, filettatura M16,
fornito con controdado, foro per fissaggio Ø 16 mm
For cables from Ø 5 to Ø 10 mm, thread M16,
supplied with nut, hole for fixing Ø 16 mm

L'alimentazione delle torrette SKYLINE può essere realizzata da sottopavimento, utilizzando il foro sulla base d'acciaio, o tramite un pressacavo che offriamo in 2 versioni: in policarbonato trasparente o in Nylon con spirale protetti cavo.

Praticare un foro adatto sul profilo in alluminio per l'inserimento del pressacavo scelto.

The power supply of the SKYLINE turrets can be made from an underfloor, using the hole in the steel base, or through a cable gland that we offer in 2 versions: in transparent polycarbonate or in Nylon with cable protecting spiral.

Drill a suitable hole on the aluminium profile for inserting the chosen cable gland.

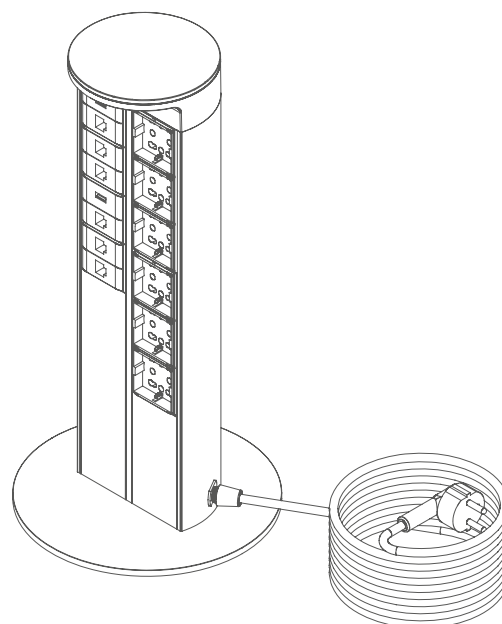

Kit LED per illuminazione interna torrette
LED kit for internal illumination turrets

Articolo Item	Descrizione Description
MTLED	Striscia LED lunghezza 110 mm Led strip length 110 mm
MTRLED	Striscia LED lunghezza 250 mm Led strip length 250 mm

- Dimensione driver 55x30x30 mm;
- La striscia LED è dotata di biadesivo;
- Per illuminazione LED utilizzate le mostrine trasparenti (.T) e i terminali (.T)
- Driver dimension 55x30x30 mm;
- The LED strip is equipped with adhesive;
- For LED lighting use the transparent frames (.T) and end piece (.T)

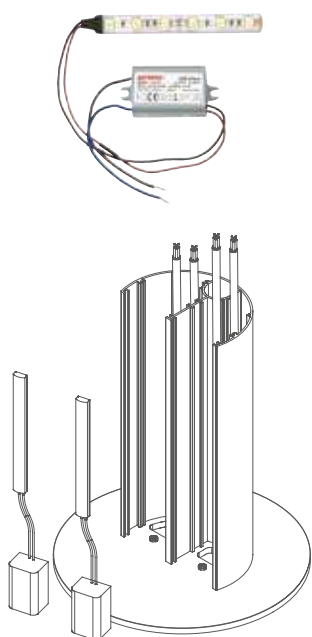

Kit LED per illuminazione tappo terminale
LED kit for end cup illumination

Articolo Item	Descrizione Description
MLED	LED per illuminazione disco terminale LED for end cup disk lighting

- La striscia LED si inserisce nell'apposito alloggiamento
- Per illuminazione LED utilizzate le mostrine trasparenti (.T)
- The LED strip fits into the appropriate housing
- For LED lighting use the transparent frames (.T)

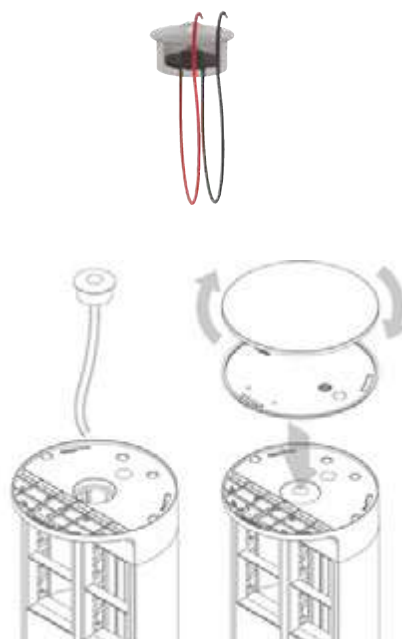

Sezione del profilo e conduttori inseribili
Section and conductors that can be inserted

MI125		Area	3x1,5 mm ²	3x2,5 mm ²	3x4 mm ²	3x6 mm ²
A mm	78	C	14	11	9	8
B mm	120	D	14	11	9	8

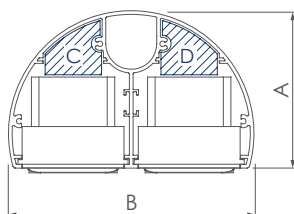

EVODESK

Torrette estraibili in ALLUMINIO

Pop-up turrets of ALUMINIUM





Caratteristiche Tecniche

- Profilo e coperchio in Alluminio
- Accessori in Poliammide
- Resistenza all'urto IK08 (5J)
- Grado di protezione IP40
- Per piani con spessore massimo 50 mm

Technical Features

- Aluminium profile and cover
- Polyamide accessories
- Mechanical protection IK08 (5J)
- Protection degree IP40
- For tops with a maximum thickness of 50 mm

Riferimenti a Norme

- La linea è conforme alla norma DIN 0620-1/02.2010
- La linea è conforme alla Direttiva RoHS 2015/863/EU
- La linea è conforme alla Direttiva B.T. 2009/95/CE

Norms Reference

- The system complied to DIN 0620-1/02.2010
- The system complied to RoHS 2015/863/EU
- The system complied to L.V.D. 2009/95/CE

Marchi e Certificazioni

- Marcatura CE

Marks and Certifications

- CE Marking

Colori disponibili



- Alluminio verniciato Bianco
- Alluminio verniciato Nero

Available colours

- White painted Aluminium
- Black painted Aluminium

Torrette estraibili elettrificabili in alluminio
Wiring pop-up turrets, of aluminium



Articolo Item		Colore Color	Descrizione Description	A mm	B mm	C mm	D mm	E mm
	M104A3	Bianco White	Per 8 moduli BTicino Living Light For 8 modules BTicino Living Light	Ø165	220	255	Ø125	MAX 50
	MA104A3		Per 8 moduli Ave 44 For 8 modules Ave 44					
	MF104A3		Per 4 moduli 45x45 mm For 4 modules 45x45 mm					
	M104N	Nero Black	Per 8 moduli BTicino Living Light For 8 modules BTicino Living Light					
	MA104N		Per 8 moduli Ave 44 For 8 modules Ave 44					
	MF104N		Per 4 moduli 45x45 mm Standard Francese For 4 modules 45x45 mm French standard					

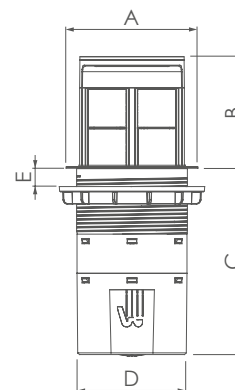

Sega a tazza per l'installazione delle torrette
Cup saw for the installation of the turrets

Articolo Item	Dimensione Dimension
MFT127	Acciaio Ø127 mm Steel Ø127 mm
	

Kit LED con driver
LED kit with driver

Articolo Item	Descrizione Description
MLED	Per l'illuminazione interna della torretta For the internal lighting of the turret
	





Su richiesta sono disponibili moduli con dimensioni e configurazioni personalizzate

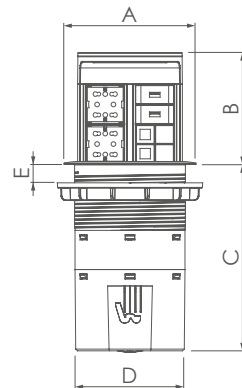

On request are available modules with different dimensions and personalized layouts

Torrette estraibili elettrificate, in alluminio
Wired pop-up turrets, in aluminium

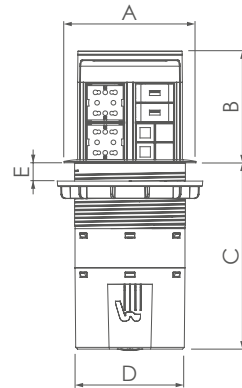

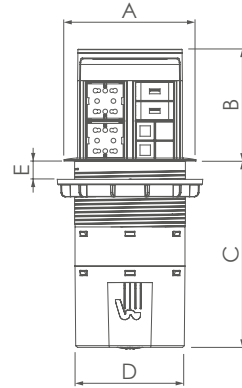
Articolo Item		Colore Color	Dotazione Equipment	A mm	B mm	C mm	D mm	E mm
	M104.4B.A3	Bianco White	Torretta cablata con 4 multi-prese (4 Schuko/8 bipasso)	Ø165	220	255	Ø125	MAX 50
	M104.4B.N	Nero Black	Turret wired with 4 multi-sockets (4 Schuko/8 bipasso)					
			Power cable length 2 meters					
	M104.4S.A3	Bianco White	Torretta cablata con 3 multi-prese (3 Schuko/6 bipasso) e 2 prese di carica USB 2.4A	Ø165	220	255	Ø125	MAX 50
	M104.4S.N	Nero Black	Turret wired with 3 multi-sockets (3 Schuko/6 bipasso) and 2 USB charge sockets 2.4A					
			Power cable length 2 meters					
	M104.4U.A3	Bianco White	Torretta cablata con 2 multi-prese (2 Schuko/4 bipasso) 2 prese di carica USB 2.4A, 2 prese RJ45 cat6	Ø165	220	255	Ø125	MAX 50
	M104.4U.N	Nero Black	Turret wired with 2 multi-sockets (2 Schuko/4 bipasso) 2 USB charging sockets 2.4A 2 RJ45 cat6 sockets					
			Power cable length 2 meters					

Su richiesta sono disponibili moduli con dimensioni e configurazioni personalizzate

Torrette estraibili elettrificate, in alluminio Wired pop-up turrets, in aluminium



Articolo Item		Colore Color	Dotazione Equipment	A mm	B mm	C mm	D mm	E mm
	M104.4R.A3	Bianco White	Torretta cablata con 3 multi-prese (3 Schuko/6 bipasso) e 2 prese RJ45 cat6 Cavo di alimentazione lunghezza 2 metri	Ø165	220	255	Ø125	MAX 50
	M104.4R.N	Nero Black	Turret wired with 3 multi-sockets (3 Schuko/6 bipasso) and 2 RJ45 cat6 sockets Power cable length 2 meters					
	M104.4L.A3	Bianco White	Torretta cablata con 3 multi-prese (3 Schuko/6 bipasso) 2 prese di carica USB 2.4A, 1 interruttore 2 poli e illuminazione LED interna Cavo di alimentazione lunghezza 2 metri	Ø165	220	255	Ø125	MAX 50
	M104.4L.N	Nero Black	Turret wired with 3 multi-sockets (3 Schuko/6 bipasso) 2 USB charging sockets 2.4A 1 2-poles switch e internal LED lighting Power cable length 2 meters					
	M102.4S.A3	Bianco White	Torretta cablata con 1 multi-presa (1 Schuko/2 bipasso) 2 prese di carica USB 2.4A e 1 presa bipasso Cavo di alimentazione lunghezza 2 metri	Ø165	180	215	Ø125	MAX 50
	M102.4S.N	Nero Black	Turret wired with 1 multi-socket (1 Schuko/2 bipasso) 2 USB charging sockets 2.4A and 1 bipasso socket Power cable length 2 meters					

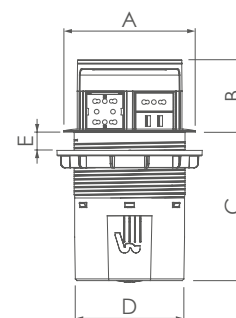
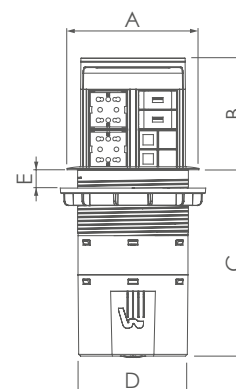
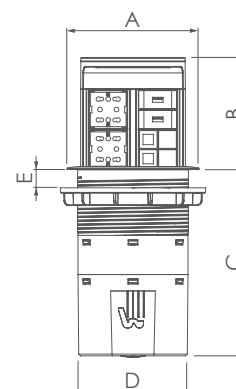

On request are available modules with different dimensions and personalized layouts

EVOMOD

PERSONALIZZABILE
CUSTOMIZABLE

Moduli elettrificabili in ALLUMINIO

Wiring modules of ALUMINIUM





Caratteristiche Tecniche

- Profilo e coperchio in Alluminio
- Accessori in Abs
- Moduli lunghezza standard 480 e 660 mm
- Apertura coperchio con attrezzo
- Resistenza all'urto IK08 (5J)
- Grado di protezione IP40
- Tensione nominale 750V

Technical Features

- Aluminium profile and cover
- Abs accessories
- Standard length modules 480 and 660 mm
- Cover disassembling with tool
- Mechanical protection IK 08 (5J)
- Protection degree IP40
- Nominal voltage 750V

Riferimenti a Norme

- Conforme alla norma CEI EN 50085-2-1
- Conforme alla Direttiva RoHS 2015/863/EU
- Conforme alla Direttiva B.T. 2009/95/CE

Norms Reference

- Complies with standard CEI EN 50085-2-1
- Compliant with RoHS Directive 2015/863/EU
- The system complied to L.V.D. 2009/95/CEC

Marchi e Certificazioni

- Marchio IMQ riferimento n° EE899
- Marcatura CE

Marks and Certifications

- IMQ mark reference n° EE899
- CE marking

Colori disponibili

- Alluminio verniciato Bianco
- Alluminio verniciato Nero goffrato
- Alluminio spazzolato e anodizzato naturale

Available colours

- White painted Aluminium
- Black goffred painted Aluminium
- Brushed and natural anodized Aluminium

Moduli elettrificabili in alluminio Wiring modules of aluminium



Articolo Item	Colori Colors	Descrizione Description	A mm	B mm	C mm
MOD1AA	Alluminio Aluminium	Base in alluminio, terminali in plastica, 3 scatole 3-4-7 moduli, 3 mostrine, 1 pressacavo M20 e 1 morsetto di terra	660	65	105
MOD1A3	Bianco White	Base of aluminium, end pieces of plastic, 3 socket boxes 3-4-7 modules, 3 3 frames, 1 cable gland M20 and 1 earthing clamp			
MOD1VN	Nero Black				

Per fissaggio sopra o sotto scrivania For fixing over or under the desk



Articolo Item	Colori Colors	Descrizione Description	A mm	B mm	C mm
MOD2AA	Alluminio Aluminium	Base in alluminio, 3 scatole 3-4-7 moduli, 3 mostrine, 1 pressacavo M20, 1 morsetto di terra e 2 terminali in acciaio inox sagomati per fissaggio	760	65	105
MOD2A3	Bianco White	Base of aluminium, 3 socket boxes 3-4-7 modules, 3 frames, 1 cable gland M20, 1 earthing clamp and 2 end pieces of stainless steel for fixing			
MOD2VN	Nero Black				

Per fissaggio a parete For wall mounting



Articolo Item	Colori Colors	Descrizione Description	A mm	B mm	C mm
MOD3AA	Alluminio Aluminium	Base in alluminio, 3 scatole 3-4-7 moduli, 3 mostrine, 1 pressacavo M20, 1 morsetto di terra e 2 terminali in acciaio inox sagomati per fissaggio	760	65	105
MOD3A3	Bianco White	Base of aluminium, 3 socket boxes 3-4-7 modules, 3 frames, 1 cable gland M20, 1 earthing clamp and 2 end pieces of stainless steel for fixing			
MOD3VN	Nero Black				

Componenti singoli per la personalizzazione Single components for the customization

Articolo Item		Descrizione Description	Colori Colours
A	BU651058	Profilo in alluminio 65x105 mm Aluminium profile 65x105 mm	A, A3, VN
B	BE1058	Terminali in plastica Plastic end piece	.AL, .2, .3
B1	TER2F	Terminali verticali in acciaio INOX Vertical end piece of stainless steel	3, N
B2	TER3F	Terminali orizzontali in acciaio INOX Horizontal end piece of stainless steel	3, N
C	686 *	Scatola porta apparecchi 3-4-7 moduli Socket box 3-4-7 modules	
	683 *	Scatola porta apparecchi 3 moduli Socket box 3 modules	
D	BMT65	Morsetto di terra Earthing clamp	
E	BS803	Mostrina in alluminio 3 moduli Aluminium frame 3 modules	A, A3, VN
	BS804	Mostrina in alluminio 4 moduli Aluminium frame 4 modules	A, A3, VN
	BS806	Mostrina in alluminio 7 moduli Aluminium frame 6-7 modules	A, A3, VN
	BS803	Mostrina in plastica 3-4-7 moduli Plastic frame 3-4-7 modules	.2, .3
F	124M2001C	Pressacavo M20 per cavi Ø 6/12mm Cable gland M20 for cables Ø 6/12mm	Grigio chiaro Light grey
	124M2003C	Pressacavo M20 per cavi Ø 6/12mm Cable gland M20 for cables Ø 6/12mm	Nero Black

.2	Plastica nera Black plastic
.3	Plastica bianca White plastic
.AL	Plastica verniciata alluminio Aluminium painted plastic
A	Alluminio anodizzato Anodized aluminium
A3	Alluminio verniciato bianco White painted aluminium
VN	Alluminio verniciato nero Black painted aluminium
3	Acciaio verniciato bianco White painted steel
N	Acciaio verniciato nero Black painted steel

*Per ulteriori info tecniche vedi pagine 172/173

*For further technical info see pages 172/173

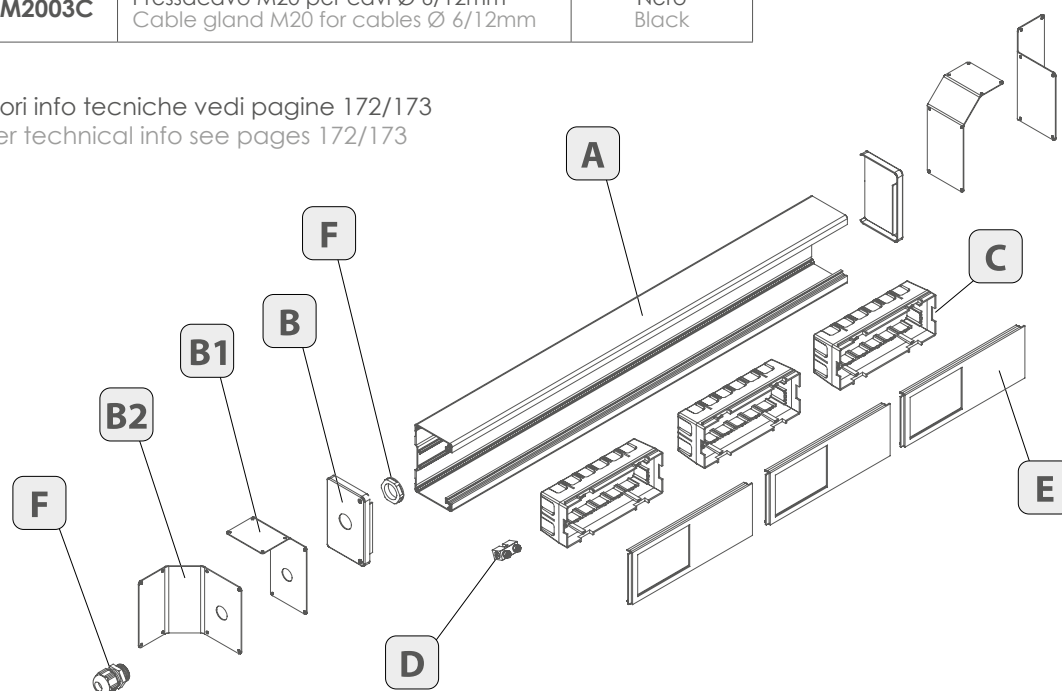

Su richiesta sono disponibili moduli con dimensioni e configurazioni personalizzate
On request are available modules with different dimensions and personalized layouts

Moduli elettrificabili in alluminio 40x90 mm Wiring modules of aluminium 40x90 mm



Articolo Item	Colori Colors	Descrizione Description	A mm	B mm	C mm
MOD93AA	Alluminio Aluminium	Base in alluminio, terminali in plastica, 3 scatole 3 moduli, 3 mostrine, 1 pressacavo M20 e 1 morsetto di terra Base of aluminium, plastic end pieces, 3 socket boxes 3 modules, 3 frames, 1 cable gland M20 and 1 earthing clamp	490	40	90
MOD93A3	Bianco White				
MOD93VN	Nero Black				

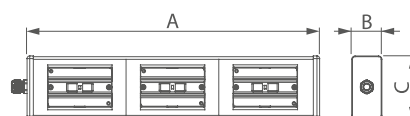

Per fissaggio sopra o sotto scrivania For fixing over or under the desk



Articolo Item	Colori Colors	Descrizione Description	A mm	B mm	C mm
MOD94AA	Alluminio Aluminium	Base in alluminio, 3 scatole 3 moduli, 3 mostrine, 1 pressacavo M20 e 1 morsetto di terra e 2 terminali in acciaio inox sagomati per fissaggio Base of aluminium, 3 socket boxes 3 modules, 3 frames, 1 cable gland M20 and 1 earthing clamp and 2 end pieces of stainless steel for fixing	590	40	90
MOD94A3	Bianco White				
MOD94VN	Nero Black				

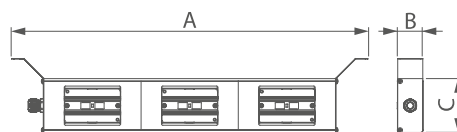

Per fissaggio a parete For wall mounting



Articolo Item	Colori Colors	Descrizione Description	A mm	B mm	C mm
MOD95AA	Alluminio Aluminium	Base in alluminio, 3 scatole 3 moduli, 3 mostrine, 1 pressacavo M20 e 1 morsetto di terra e 2 terminali in acciaio inox sagomati per fissaggio Base of aluminium, 3 socket boxes 3 modules, 3 frames, 1 cable gland M20 and 1 earthing clamp and 2 end pieces of stainless steel for fixing	590	40	90
MOD95A3	Bianco White				
MOD95VN	Nero Black				

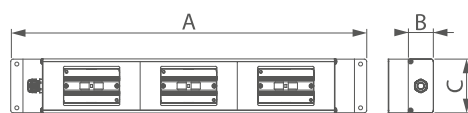

Componenti singoli per la personalizzazione Single components for the customization

Articolo Item		Descrizione Description	Colori Colours
A	BU40908	Profilo in alluminio 40x90 mm Aluminium profile 40x90 mm	A, A3, VN
B	BE908	Terminali in plastica Plastic end piece	.AL, .2, .3
B1	MS2F	Terminali verticali in acciaio INOX Vertical end piece of stainless steel	3, N
B2	MS3F	Terminali orizzontali in acciaio INOX Horizontal end piece of stainless steel	3, N
C	683-40	Scatola porta apparecchi 3 moduli Socket box 3 modules	
D	BMT65	Morsetto di terra Earthing clamp	
E	BS80-53R	Mostrina in alluminio 3 moduli Aluminium frame 3 modules	A, A3, VN
F	124M2001C	Pressacavo M20 per cavi Ø 6/12mm Cable gland M20 for cables Ø 6/12mm	Grigio chiaro Light grey
	124M2003C	Pressacavo M20 per cavi Ø 6/12mm Cable gland M20 for cables Ø 6/12mm	Nero Black

.2	Plastica nera Black plastic
.3	Plastica bianca White plastic
.AL	Plastica verniciata alluminio Aluminium painted plastic
A	Alluminio anodizzato Anodized aluminium
A3	Alluminio verniciato bianco White painted aluminium
VN	Alluminio verniciato nero Black painted aluminium
3	Acciaio verniciato bianco White painted steel
N	Acciaio verniciato nero Black painted steel

Per ulteriori info tecniche vedi pagine 172/173
For further technical info see pages 172/173

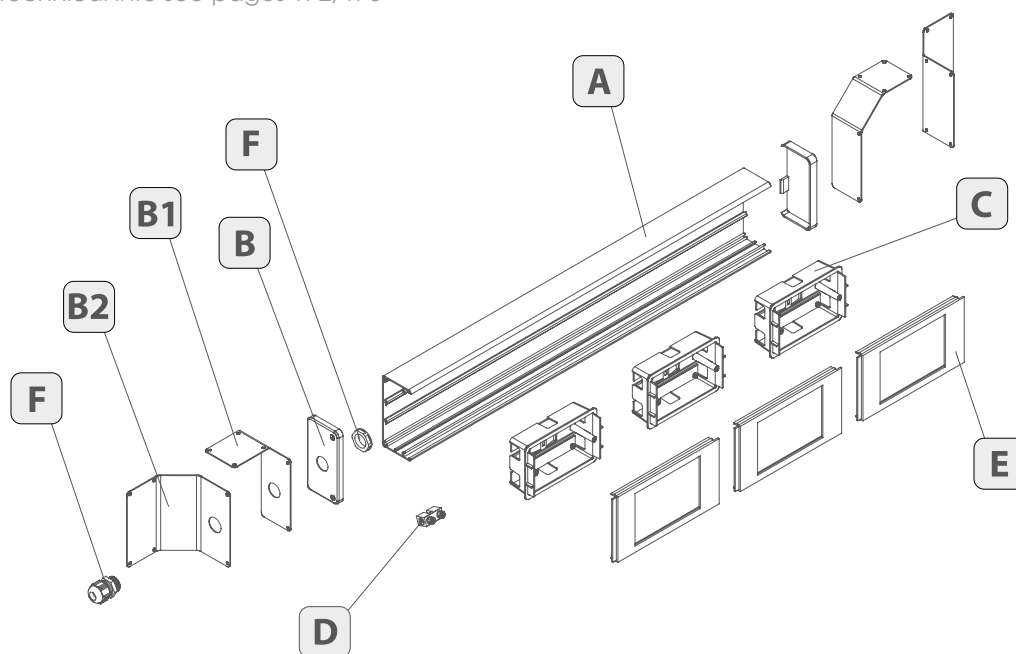

Su richiesta sono disponibili moduli con dimensioni e configurazioni personalizzate
On request are available modules with different dimensions and personalized layouts

Supporto di fissaggio a morsetto per scrivania
Fixing support clamp for desk

Articolo Item	Colore Item		
MST.V3M	Bianco White		
MST.VNM	Nero Black		

Per il fissaggio dei moduli a scrivanie o tavoli senza forare il piano
For fixing the modules to desks or tables without drilling the top

Scatola porta apparecchi per canali H65 mm
Socket box for trunkings H65 mm

Articolo Item	Moduli e standard Modules and standard	A mm	B mm	C mm	D mm
SP660	2 italiani - italian 1 tedesco - german 1 inglese - english	70	55	80	60
SP664	4 italiani - italian	132	55	80	108,5
SP664E	2 inglesi - english	144	55	80	120,6
SP667	7 italiani - italian	184	55	80	100



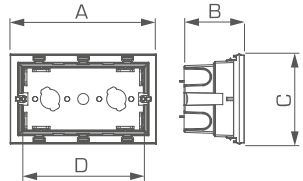

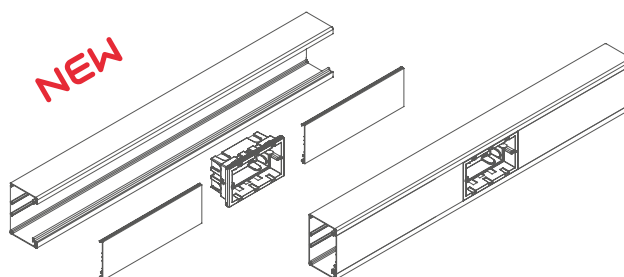

NUOVE scatole porta apparecchi con aggancio a scatto sul bordo del canale. Questo sistema permette di non usare le mostrine accostando il coperchio alla scatola.

VANTAGGI:

1. Un risultato estetico migliore senza interruzioni del coperchio
2. Una flessibilità maggiore nel posizionamento della scatola
3. Un risparmio economico in quanto non si usano le mostrine

NEW socket boxes with snap hook on the edge of the trunking. This system allows you not to use the frames holding the cover to the box.

ADVANTAGES:

1. A better aesthetic result without interruptions of the cover
2. Greater flexibility in the positioning of the box
3. An economic saving as the frames are not used

Morsetto di terra
Earthing clamp

Articolo Item	A mm	B mm	C mm	ØD mm
BMT65	20	8,5	15,5	6



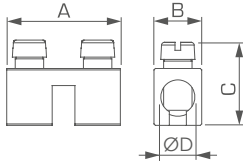





Sezione del profilo e quantità conduttori inseribili al suo interno
Section and quantity of conductors that can be inserted

BU40908		Numero di conduttori tripolari inseribili nel profilo Number of tripolar cables insertable in the profile					
A mm	90	Area	3x1,5 mm ²	3x2,5 mm ²	3x4 mm ²	3x6 mm ²	
B mm	80	D	4	3	3	2	
C mm	40	E	4	3	3	2	

Sezione del profilo e quantità conduttori inseribili al suo interno
Section and quantity of conductors that can be inserted

BU651058		Numero di conduttori tripolari inseribili nel profilo Number of tripolar cables insertable in the profile					
A mm	105	Area	3x1,5 mm ²	3x2,5 mm ²	3x4 mm ²	3x6 mm ²	
B mm	80	D	14	11	9	8	
C mm	65	E	14	11	9	8	

Su richiesta sono disponibili moduli con dimensioni e configurazioni personalizzate
 On request are available modules with different dimensions and personalized layouts

E-DESK

Componenti per l'elettrificazione dei posti di lavoro

Components for workstations electrification





Caratteristiche Tecniche

- Canaline flessibili in Poliammide e Polipropilene
- Staffe portacomputer in acciaio inox o verniciato
- Box porta computer in acciaio verniciato
- Guaina trecciata estensibile in Poliestere con velcro

Technical Features

- Flexible Trunkings of Polyamide and Polypropylene
- PC brackets of stainless steel or painted steel
- Computer box painted steel
- Polyester expansible braided sleeve with velcro

Riferimenti a Norme

- La linea è conforme alla norma DIN 0620-1/02.2010
- La linea è conforme alla Direttiva RoHS 2015/863/EU
- La linea è conforme alla Direttiva B.T. 2009/95/CE

Norms Reference

- Complies with standard DIN 0620-1/02.2010
- Compliant with RoHS Directive 2015/863/EU
- The system complied to L.V.D. 2009/95/CE

Marchi e Certificazioni

- Marcatura CE

Marks and Certifications

- CE marking

Colori disponibili



- Bianco, Nero, Grigio

Available colours

- White, Black, Grey

Staffe porta computer
Computer brackets



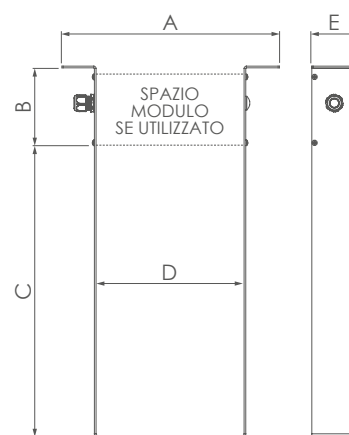

Articolo Item	Descrizione Description	A mm	B mm	C mm	D mm	E mm
	<p>MSC240X</p> <p>Coppia di staffe in acciaio INOX fissaggio con viti sotto scrivania</p> <p>Pair of brackets in stainless steel, fixing with screws under the desk</p>	324	117	433	225	67
	<p>MSC240N</p> <p>Coppia di staffe in acciaio INOX verniciato NERO, fissaggio con viti sotto scrivania</p> <p>Pair of brackets in BLACK painted stainless steel, fixing with screws under the desk</p>					
	<p>MSE240X</p> <p>Coppia di staffe in acciaio INOX, con modulo in alluminio elettrificabile, con 1 scatola 3, 4, 7 posti e 1 pressacavo M20 per cavi Ø 6/12 mm</p> <p>Pair of brackets in stainless steel, with electrifiable aluminum module, with 1 box 3, 4, 7 places, 1 cable gland M20 for cables Ø 6/12 mm</p>	324	117	433	225	67
	<p>MSE240N</p> <p>Coppia di staffe acciaio INOX verniciato, con modulo in alluminio elettrificabile, con 1 scatola 3, 4, 7 posti, 1 pressacavo M20 per cavi Ø 6/12 mm</p> <p>Pair of brackets in painted stainless steel, with electrifiable aluminum module, with 1 box 3, 4, 7 places, 1 M20 cable gland for cables Ø 6/12 mm</p>					



Box porta computer Computer box

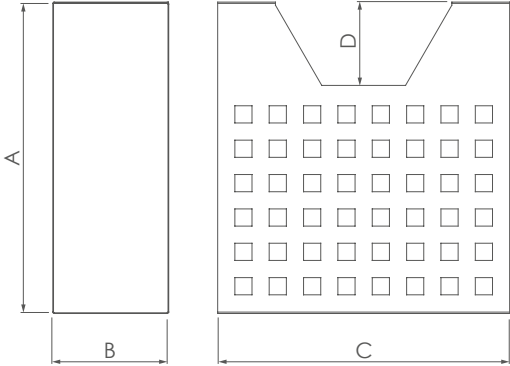

Articolo Item		Descrizione Description	A mm	B mm	C mm	D mm
	MBE240W	<p>Box in acciaio verniciato BIANCO fissaggio con viti sotto scrivania</p> <p>WHITE painted steel box fixing with screws under the desk</p>	540	210	500	145
	MBE240N	<p>Box in acciaio verniciato NERO fissaggio con viti sotto scrivania</p> <p>BLACK painted steel box fixing with screws under the desk</p>				



Canali passacavi flessibili Flexible cable trunking

Articolo Item		Colore Color	Descrizione Description
	MRC70G	Grigio Grey	Canale tondo snodato Ø 70 mm, lunghezza aperto 95 cm, lunghezza retracts 75 cm in Polipropilene, 2 scomparti, per il passaggio di cavi da una scrivania a pavimento Round articulated trunking Ø 70 mm, opened length 95 cm, retracted length 75 cm in Polypropylene, 2 compartments, for routing cables from a desk to the floor
	MRC70N	Nero Black	
	MAR	Grigio Grey	Attacco per canale tondo snodato da fissare sotto scrivania con viti Fixing piece for round trunking to be fixed under the desk with screws
	MRD200G	Grigio Grey	Raccordo di derivazione in polipropilene tra canale a pavimento MKP e canale tondo flessibile MRC, fissaggio a pavimento con supporto in acciaio Polypropylene derivation between floor trunking MKP and round trunking MRC, floor fixing with painted steel support
	MRD200N	Nero Black	
	MRF200G	Grigio Grey	Flangia per passaggio da canale tondo a pavimento flottante Frame between round trunking and floating floor
	MRF200N	Nero Black	

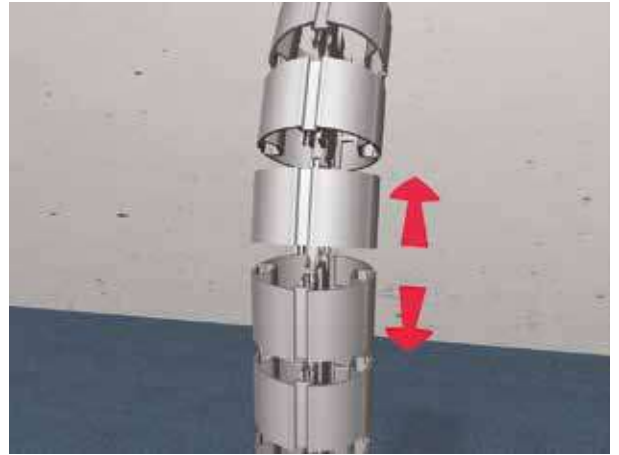
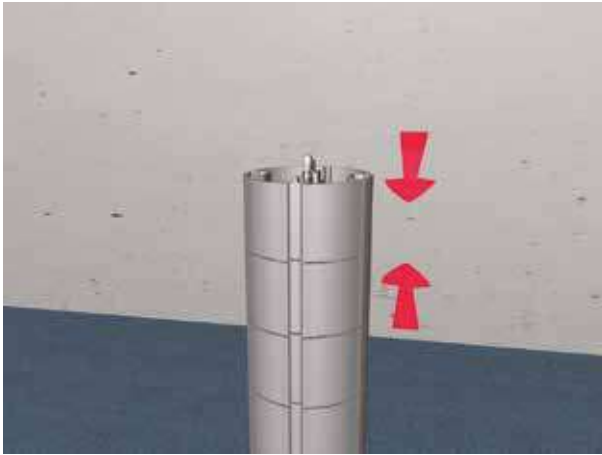

Canali passacavi flessibili Flexible cable trunking

Articolo Item		Colore Color	Descrizione Description
	MKP2080G	Grigio Grey	<p>Canale soprapavimento snodato 83x20 mm, in poliammide, 2 scomparti, lunghezza aperto 100 cm, lunghezza retratto 80 cm</p> <p>Articulated overfloor trunking 83x20 mm, in polyamide, 2 compartments, opened length 100 cm, retracted length 80 cm</p>
	MKP2080N	Nero Black	

Guaina trecciata estensibile in poliestere con velcro Polyester expansible braided sleeve with velcro

Articolo Item		Colore Color	Descrizione Description	Quantità Quantity
	MGE30	Nero Black	Guaina estensibile Ø30 mm Extensible sheath Ø30 mm	Rotolo da 25 m Roll of 25 m
	MGE50		Guaina estensibile Ø50 mm Extensible sheath Ø50 mm	
	MGE30B		Guaina estensibile Ø30 mm Extensible sheath Ø30 mm	Blister da 1,5 m Blister of 1,5 m
	MGE50B		Guaina estensibile Ø50 mm Extensible sheath Ø50 mm	





Esempio di applicazione di guaina trecciata per la raccolta di cavi sul retro di computer.

Example of application of braided sleeve for bundling cables on the back of computers.

Moduli elettrificabili in plastica Electrifiable modules in plastic

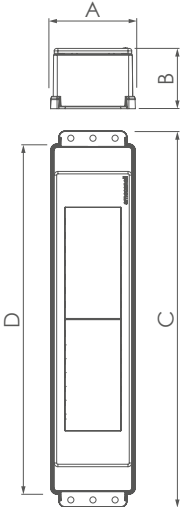

Articolo Item		Colore Color	Descrizione Description	A mm	B mm	C mm	D mm
	SPA08.3	Bianco White	<p>Il modulo è personalizzabile con frutti AVE 44 fino a 8 moduli (vedi pagina 181) è possibile fissarlo con adesivo o con viti</p>	69	50	305	280
							
	SPA08.2	Nero Black	<p>The module is customizable with sockets AVE 44 up to 8 modules (see page 181) it can be fixed with adhesive or screws</p>				



Prese e interruttori tipo BTicino Living Light BTicino Living Light type sockets and switches



Articolo Item		Colore Colour	Moduli Modules	Aggancio Coupling	Descrizione Description
	MPB2LL.W	Bianco/White	1	BTicino LivingLight	Presa bipasso 2P+T, 10/16A - 250V Combined italian socket 2P+T, 10/16A - 250V
	MPB2LL.N	Nero/Black			
	MPB2LL.A	Alluminio/Aluminium			
	MPB2LL.R	Rosso/Red			
	M4B.LL.W	Bianco/White	2	BTicino LivingLight	Multi-presa Schuko-bipasso, 2P+T, 10/16A - 250V Multi-socket Schuko-bipasso, 2P+T, 10/16A - 250V
	M4B.LL.N	Nero/Black			
	M4B.LL.A	Alluminio/Aluminium			
	M4B.LL.R	Rosso/Red			
	MSB2LL.W	Bianco/White	2	BTicino LivingLight	Presa Schuko bipasso 2P+T, 10/16A - 250V Combined Schuko socket 2P+T, 10/16A - 250V
	MSB2LL.N	Nero/Black			
	MSB2LL.A	Alluminio/Aluminium			
	MSB2LL.R	Rosso/Red			
	M2FLL.W	Bianco/White	2	BTicino LivingLight	Presa Schuko Francese 2P+T, 16A - 250V Schuko French socket 2P+T, 16A - 250V
	M2FLL.N	Nero/Black			
	M2FLL.A	Alluminio/Aluminium			
	M2ELL.W	Bianco/White	2	BTicino LivingLight	Presa Inglese BS1363 2P+T, 13A - 250V British socket BS1363 2P+T, 13A - 250V
	M2ELL.N	Nero/Black			
	M2ELL.A	Alluminio/Aluminium			
	M2ELL.R	Rosso/Red			
	M4B.LS.W	Bianco/White	1	BTicino LivingLight	Presa caricatore USB 2.4 A, 2 uscite USB charger socket 2.4 A, 2 outlets
	M4B.LS.N	Nero/Black			
	M4B.LS.A	Alluminio/Aluminium			
	MPRJ6LL.W	Bianco/White	1	BTicino LivingLight	Presa RJ45 CAT.6 UTP, T568A/B - 8 contatti RJ45 socket CAT.6 UTP, T568A/B - 8 contacts
	MPRJ6LL.N	Nero/Black			
	MPRJ6LL.A	Alluminio/Aluminium			
	M4B.LH.W	Bianco/White	1	BTicino LivingLight	Presa Schuko bipasso 2P+T, 10/16A - 250V e caricatore USB C 3.0A Schuko BIPASSO socket 2P+T, 10/16A - 250V and USB charger socket 3.0A
	M4B.LH.N	Nero/Black			
	M4B.LH.A	Alluminio/Aluminium			
	M4B.LT.W	Bianco/White	1	BTicino LivingLight	Tappo copriforo 1 modulo Empty plate 1 module
	M4B.LT.N	Nero/Black			
	M4B.LT.A	Alluminio/Aluminium			
	M2PLL.W	Bianco/White	1	BTicino LivingLight	Interruttore bipolare 16A 2 ways switch 16A
	M2PLL.N	Nero/Black			
	M2PLL.A	Alluminio/Aluminium			

Prese e interruttori tipo Ave 44 Ave 44 type sockets and switches



Articolo Item		Colore Colour	Moduli Modules	Aggancio Coupling	Descrizione Description
	MPB2PT.W	Bianco/White	1	AVE44	Presa bipasso 2P+T, 10/16A - 250V Combined italian socket 2P+T, 10/16A - 250V
	MPB2PT.N	Nero/Black			
	MPB2PT.A	Alluminio/Aluminium			
	MPB2PT.R	Rosso/Red			
	MSB2PT.W	Bianco/White	2	AVE44	Presa Schuko bipasso 2P+T, 10/16A - 250V Combined Schuko socket 2P+T, 10/16A - 250V
	MSB2PT.N	Nero/Black			
	MSB2PT.A	Alluminio/Aluminium			
	MSB2PT.R	Rosso/Red			
	MPS2PT.W	Bianco/White	2	AVE44	Presa Schuko 2P+T, 16A - 250V Schuko socket 2P+T, 16A - 250V
	MPS2PT.N	Nero/Black			
	MPS2PT.A	Alluminio/Aluminium			
	MPS2PT.R	Rosso/Red			
	MSF2PT.W	Bianco/White	2	AVE44	Presa Schuko Francese 2P+T, 16A - 250V Schuko French socket 2P+T, 16A - 250V
	MSF2PT.N	Nero/Black			
	MSF2PT.A	Alluminio/Aluminium			
	MSF2PT.R	Rosso/Red			
	MPE2PT.W	Bianco/White	2	AVE44	Presa Inglese BS1363 2P+T, 13A - 250V British socket BS1363 2P+T, 13A - 250V
	MPE2PT.N	Nero/Black			
	MPE2PT.A	Alluminio/Aluminium			
	MCUSB.W	Bianco/White	1	AVE44	Caricatore USB, 5V 2,1A 110-240V, 50-60 Hz USB loader, 5V 1,2A, 110-240V, 50-60 Hz
	MCUSB.N	Nero/Black			
	MCUSB.A	Alluminio/Aluminium			
	MPRJ6.W	Bianco/White	1	AVE44	Presa RJ45 CAT.6 UTP, T568A/B - 8 contatti RJ45 socket CAT.6 UTP, T568A/B - 8 contacts
	MPRJ6.N	Nero/Black			
	MPRJ6.A	Alluminio/Aluminium			
	MRJ11.W	Bianco/White	1	AVE44	Presa telefonica RJ11, 6 poli - 4 contatti RJ11 Telephone socket, 6 poles - 4 contacts
	MRJ11.N	Nero/Black			
	MRJ11.A	Alluminio/Aluminium			
	MTCF1.W	Bianco/White	1	AVE44	Tappo copriforo 1 modulo Empty plate 1 module
	MTCF1.N	Nero/Black			
	MTCF1.A	Alluminio/Aluminium			
	MIN2P.W	Bianco/White	1	AVE44	Interruttore bipolare 16A 2 ways switch 16A
	MIN2P.N	Nero/Black			
	MIN2P.A	Alluminio/Aluminium			



Norme e certificazioni

Marchatura CE

Il regolamento CE 768/2008 stabilisce le norme generali per garantire la conformità dei prodotti ai requisiti applicabili. La direttiva bassa tensione 2014/35/UE (Decreto L.vo 86 - 2016) recepisce il regolamento per il materiale elettrico destinato ad essere adoperato entro i previsti limiti di tensione. I prodotti che rientrano nel campo di applicazione della direttiva sono conformi ai requisiti essenziali di sicurezza per la salute, l'ambiente e la protezione dei consumatori. La conformità alla direttiva è ottenuta mediante l'apposizione del marchio e di tutti i simboli e le marcature previste sul prodotto, sull'imballaggio, sulle istruzioni di montaggio, sul catalogo e mediante la piena rispondenza alle norme di prodotto armonizzate applicabili. La marcatura non implica il controllo da parte di un organismo di accreditamento o di valutazione della qualità e pertanto non è alternativa o sostitutiva dei marchi di qualità. La presenza di prestigiosi marchi di qualità rappresenta un'ulteriore garanzia per installatore e committente di conformità dell'impianto elettrico alla regola dell'arte ai sensi del DM 37 - 2008.

Norme e relativa classificazione dei prodotti

I canali porta cavi e porta apparecchi sono certificati secondo la Norma europea:

- EN 50085-1** Sistemi di canali e di condotti per installazioni elettriche
- EN 50085-2-1** Sistemi di canali e di condotti per montaggio a parete e a soffitto
- EN 50085-2-2** Sistemi di canali e di condotti per montaggio a pavimento
- EN 50085-2-4** Sistemi di colonne e torrette

La Norma EN 50085 definisce le prescrizioni e le prove per i sistemi di canali e di condotti, dedicati all'alloggiamento di conduttori, cavi, altre apparecchiature elettriche ed eventualmente alla loro segregazione, nelle installazioni elettriche e/o per i sistemi di comunicazione con tensioni fino a 1000 V in corrente alternata e/o 1500 V in corrente continua. La Parte 1 della Norma, relativa alle prescrizioni generali, è in vigore dal 1° Maggio 2006 e deve essere utilizzata congiuntamente alle Parti 2.

La Parte 2-1 riguarda i sistemi di canali per installazione a parete e a soffitto, è in vigore dal 1° marzo 2007; La Parte 2-2 si riferisce ai vari sistemi di canali e condotti per montaggio a pavimento, è applicabile in Italia dal 1° ottobre 2009; La Parte 2-4 tratta gli specifici requisiti per le colonne e le torrette e ha sostituito la Norma italiana CEI 23.73 dal 1° maggio 2012.

Le tabelle seguenti riportano la classificazione dei sistemi richiesta dalla normativa, i relativi riferimenti e le caratteristiche a cui i prodotti Arnocanali rispondono. La classificazione è riferita al Sistema di canali CTS (Cable Trunking System) e al Sistema di condotti CDS (Cable Ducting System), un insieme comprendente un tratto rettilineo di canale ed eventualmente altri componenti del sistema per realizzare un involucro per l'alloggiamento di conduttori, cavi, e di altre apparecchiature elettriche. I prodotti Arnocanali ammessi al regime del marchio dell'Istituto Italiano del Marchio di Qualità (IMQ) sono stati verificati ed attestati conformi alle prescrizioni delle suddette Norme.

Norme impianto

Un impianto è considerato installato a regola d'arte se, oltre all'impiego di materiali conformi alle relative Norme CEI, rispetta le prescrizioni normative specifiche o gli usi da esse richiamati per la funzione ed il tipo di ambiente cui è destinato. Le Norme CEI che disciplinano l'installazione dei prodotti Bocchiotti e di ogni altro sistema di canalizzazione in materiale plastico isolante nelle più comuni situazioni installative sono quelle emesse dal Comitato Tecnico 64 (Impianti elettrici utilizzatori a tensione nominale non superiore a 1000 V in corrente alternata e a 1500 V in corrente continua).

Fra queste citiamo di particolare rilevanza:

CEI 64-2 (2001) + EN 60079-14 (2004): Impianti elettrici nei luoghi con pericolo di esplosione;
 CEI 64-8 parti da 1 a 7 Ed. V2003: Impianti elettrici utilizzatori a tensione nominale non superiore a 1000V in corrente alternata e 1500 V in corrente continua.

La Norma europea EN 60529 prevede una classificazione degli indici di protezione secondo il grado IP e la Norma europea EN 62262 prevede una classificazione degli indici di protezione secondo il grado IK.

Grado di protezione IP

La Norma Europea EN 60529 prevede una classificazione degli indici di protezione secondo il grado IP e la Norma Europea EN 50102 prevede una classificazione degli indici di protezione secondo il grado IK.

1ª CIFRA GRADO IP		2ª CIFRA GRADO IP	
Resistenza alla penetrazione dei corpi solidi		Resistenza alla penetrazione di liquidi	
0	Nessuna protezione	0	Nessuna protezione
1	Protezione contro corpi solidi dimensione superiore a 50 mm	1	Protezione contro le cadute verticali di gocce d'acqua
2	Protezione contro corpi solidi dimensione superiore a 12 mm	2	Protezione contro cadute verticali fino 15° di gocce d'acqua
3	Protezione contro corpi solidi dimensione superiore a 2,5 mm	3	Protetto contro la pioggia
4	Protezione contro corpi solidi dimensione superiore a 1 mm	4	Protetto contro gli spruzzi di acqua
5	Protetto contro la polvere	5	Protetto contro i getti di acqua
6	Totalmente protetto contro la polvere	6	Protetto contro le ondate
		7	Protetto contro gli effetti della immersione
		8	Protetto contro gli effetti della sommersione

Grado di protezione IK

Grado IK	Equivalenza in joule dell'urto	Grado IK	Equivalenza in joule dell'urto
00	0	06	1,0
01	0,15	07	2,0
02	0,20	08	5,0
03	0,35	09	10,0
04	0,50	10	20,0
05	0,70		

Dichiarazione di conformità da parte dell'installatore

(Legge n.46/90 del 05/03/1990)

In piena sintonia con le disposizioni del Legislatore, i prodotti Arnocanali ammessi al regime del marchio di conformità IMQ e/o dei più prestigiosi marchi di conformità internazionali sollevano l'installatore da una gravosa incombenza prevista dalla Legge n° 46/90: la verifica e la dichiarazione sotto la propria responsabilità che i suddetti prodotti garantiscano un adeguato grado di sicurezza. Anche per materiali prodotti a regola d'arte dovrà comunque essere garantita l'idoneità all'ambiente.

Certificazioni IMQ

Riportiamo un prospetto generale del codice di identificazione delle certificazioni IMQ possedute dai nostri prodotti da installazione.

Chi desiderasse avere copia di una certificazione è possibile scaricarla dal nostro sito web www.arnocanali.it nell'area certificazioni della home.

Linea Line	Descrizione Description	Certificato Certification
MINIKAPPA	Sistema di minicanali in Pvc Minitrunking system of Pvc	N. EP004 N. EE893
KAPPA	Sistema di canali portacavi e distribuzione in Pvc Distribution and cable trunking system of Pvc	N. CA02.00112 N. CA02.00113
SPACE	Sistema di canali di distribuzione in Pvc Parapet trunking system of Pvc	N. EE897
ALUSPACE	Sistema di canali di distribuzione in Alluminio Parapet trunking system of Aluminium	N. EE899
TWIN	Torrette e colonne in Alluminio Turrets and office-poles of Aluminium	N. CA02.01015 N. CA02.01019
CAMBER	Canali soprapavimento in Pvc Over-floor trunking system of Pvc	N. CA02.02902
TORA	Torrette bifacciali in Plastica Bifacial turrets of Plastic	N. CA02.01017
WING	Sistemi di canali a battiscopa e cornice in Pvc Wall and skirting trunking systems of Pvc	N. EE889 N. EE890
DOUBLE	Sistemi di canali a parete e battiscopa in Pvc Wall and skirting trunkings systems of Pvc	N. EE892
CORNER	Sistemi di canali angolari in Pvc Corner trunking system of Pvc	N. EE891

Marchatura dei prodotti Arnocanali

La marchiatura dei prodotti Arnocanali, oltre a garantire la conformità alle prescrizioni normative in materia, è stata studiata per consentire un'agevole identificazione del produttore, del tipo e dimensione del prodotto, le certificazioni possedute e lotto produttivo. Laddove, per ragioni tecniche, non fosse stato possibile apporre parte delle marchiature sul prodotto, esse vengono riportate direttamente sull'etichetta della confezione.

Riportiamo, a titolo di esempio, la marchiatura apposta sul corpo del canale K6060.

arnocanali	Via Giuseppe Di Vittorio 34 50067 - Firenze - ITALY	K6060 Canale 60x60 mm		1238574	 8018138140552
1	2	3	4	5	6

- 1** Identificazione produttore
- 2** Indirizzo della sede
- 3** Articolo e dimensione
- 4** Certificazioni e dichiarazioni
- 5** Lotto produttivo
- 6** Codice a barre

Guida alla scelta dei sistemi di canalizzazione

In funzione del grado di protezione IP richiesto dalle norme impianto (CEI64) per diversi tipi di locali di posa.

Descrizione del locale esplicitamente richiamato dalla norma	Grado IP minimo richiesto	Norma di riferimento	Classificazione							
			MINIKAPPA	KAPPA	SPACE	ALUSPACE	CAMBER	WING	DOUBLE	CORNER
Impianti elettrici utilizzatori (condizioni normali)	IP XXB (IP 2X) fuori portata di mano	CEI 64-8/4 412.2.1	•	•	•	•	•	•	•	•
	IP XXD (IP 4X) a portata di mano	CEI 64-8/4 412.2.2	•	•	•	•	•	•	•	•
Bagni e docce	IP X1 (zona3) IPX4 (zona 1 e 2)(1)	CEI 64-8/7 701.512.2								
Bagni pubblici	IP X5 (zona 1, 2 e 3)	CEI 64-8/7 701.512.2								
Piscine	IP X2 :- IP X8 secondo zone e gli ambienti	CEI 64-8/7 703.411.1.3.7								
Saune (locali conteneti riscaldatori)	IP XXB (IP 2X) (circuiti SELV)	CEI 64-8/7 703.411.1.3.7	•	•	•	•	•	•	•	•
	IP 24	CEI 64-8/7 703.512.2								
Strutture ad uso agricolo zootecnico	IP XXB (IP 2X) (circuiti SELV)	CEI 64-8/7 705.411.1.3.7	•	•	•	•	•	•	•	•
	(2)	CEI 64-8/7 705								
Alberghi, pensioni, dormitori >25 posti letto	IP4X	CEI 64-8/7 751.04.1	•	•	•	•	•	•	•	•
Scuole, accademie, locali di spettacolo e/o intrattenimento	IP4X	CEI 64-8/7 751.04.1	•	•	•	•	•	•	•	•
Ambienti per esportazione, ambienti vendita all'ingrosso con superficie >400 m ²	IP4X	CEI 64-8/7 751.04.1	•	•	•	•	•	•	•	•
Stazioni sotterranee di ferrovie, metropolitane e simili	IP4X	CEI 64-8/7 751.04.1	•	•	•	•	•	•	•	•
Ambienti per degenti in ospedali e ospizi	IP4X	CEI 64-8/7 751.04.1	•	•	•	•	•	•	•	•
Ambienti destinati a detenuti	IP4X	CEI 64-8/7 751.04.1	•	•	•	•	•	•	•	•
Ambienti destinati a bambini negli asili	IP4X	CEI 64-8/7 751.04.1	•	•	•	•	•	•	•	•
Edifici di civile abitazione con altezza gronda >24 m	IP4X	CEI 64-8/7 751.04.1	•	•	•	•	•	•	•	•
Edifici storici, biblioteche, musei, gallerie d'arte, e collezioni	IP4X	CEI 64-8/7 751.04.1	•	•	•	•	•	•	•	•
Luoghi conduttori ristretti	IP XXB (circuiti SELV)	CEI 64-8/7 706.411.1.3.7	•	•	•	•	•	•	•	•
	(3)		•	•	•	•	•	•	•	•
Cantieri di costruzione e demolizione	(4)	CEI 64-8/7 704	•	•	•	•	•	•	•	•

• = Canale installabile • = Compatibile con le condizioni ambientali

(1) Ammesso IP XXB (ai soli fini di protezione contro i contatti diretti) dove si utilizzano circuiti SELV (sez.i 70 ..., art. 411.1.3.7)

(2) Non esplicitato nella nuova edizione normativa. Nella precedente: IP 44.

(3) Non esplicitato nella nuova edizione normativa. Nella precedente: IP 4X.

(4) Non esplicitato nella nuova edizione normativa. Nella precedente: (IP 2X) fuori portata di mano (IP 4X) a portata di mano.

N.B. Questo elenco non esaurisce tutte le possibilità di installabilità, che possono essere utilizzati, per quanto riguarda il grado IP, in tutti quei locali o parti di locale ed applicazioni che richiedono un grado IP non superiore a 40. La presente tabella è da considerarsi un supporto esemplificativo, soggetto a revisioni, modifiche e ampliamenti a totale discrezione di Arnocanali.

Caratteristiche tecniche dei materiali

I prodotti Arnocanali per installazione soddisfano le innumerevoli esigenze installative create da diverse condizioni d'uso e d'ambiente. Sono fabbricati con materiali ad elevate prestazioni; sono controllati nella costanza dei parametri qualitativi; vengono sottoposti a rigorosi controlli ed a severe prove di affidabilità alle condizioni limite di esercizio e di durata.

Qui di seguito si elencano le caratteristiche principali dei materiali:

Caratteristiche e proprietà	Unità	Norma	PVC	ABS	PA6	PC	PP+FV
FISICHE							
Peso specifico	g/cm ³	STM D792	1,58	1,05	1,18	1,2	1,08
Assorbimento H ₂ O 23°C	%	ISO 62	<0,1	0,2	1,8	0,33	0,1
Formaldeide	ppm	-	Assente	Assente	Assente	Assente	Assente
Cadmio	ppm	-	Assente	Assente	Assente	Assente	Assente
MECCANICHE							
Carico di rottura a trazione	MPa	ASTM D638	36	44	80	63	80
Carico di snervamento a trazione	MPa	ASTM D638	38	39	-	6	-
Allungamento a rottura	%	ASTM D638	100	18	5	80	5
Modulo elasticità a trazione	MPa	ASTM D790	3000	2600	3100	2300	-
Modulo elasticità a trazione	MPa	ASTM D790	1500	2500	2900	2250	4550
TERMICHE							
Temperatura VICAT	°C	ASTM D1525	80	102	210	140	117
Temperatura HDT	°C	ISO 75-2/A	68	95	75	125	88
Coefficiente di dilatazione	K ⁻¹	DIN 53752	8x10 ⁻⁵	5x10 ⁻⁵	9x10 ⁻⁵	6x10 ⁻⁵	15x10 ⁻⁵
Colore specifico	KJ/kg°K	DIN 52612	0,85	1,80	1,80	-	1,10
Conducibilità termica	W/m°K	DIN 52612-1	0,130	0,130	0,215	0,180	0,134
ELETRICHE							
Costante dielettrica	-	IEC 60250	3,2 ÷ 4,0	2,4	3,5	2,96	2,3
Rigidità dielettrica	kV/mm	IEC 60243	70	20	17	29	48
Resistività di superficie	Ohm	IEC 60093	10 ¹³	10 ¹⁶	10 ¹³	10 ¹⁴	10 ¹⁵
RESISTENZA AL FUOCO							
Autoestinguenza 1,6 mm	-	UL 94	V-0	HB	V2	HB	HB
Autoestinguenza 3,2 mm	-	UL 94	V-0	HB	V2	HB	HB
Filo incandescente 2 mm	°C	IEC 60695-2-13	960	650	960	850	650
indice O ₂	%	ISO 4589	43	-	-	-	-

La Arnocanali si pone quale obiettivo primario l'ottimizzazione produttiva e tecnologica recependo costantemente l'evoluzione delle Norme e dei materiali, ciò comporta la possibile modificazione, senza alcun preavviso, delle caratteristiche tecniche sopra indicate. Per qualsiasi applicazione particolare o al limite delle prestazioni è necessario contattare il laboratorio.

Separazione e segregazione dei circuiti

L'impianto elettrico ha sempre maggiori esigenze di separazione e segregazione circuiti in funzione della molteplicità di utenze, livelli di tensioni e livelli funzionali (vedi a tal proposito la Norma EN 50085-1 Articoli 3.34/3.35). La canalizzazione a vista contribuisce alla razionalizzazione dei circuiti e soddisfa pienamente la separazione elettrica degli stessi. Ricordiamo infatti che nella separazione elettrica non è mai opportuno fare coesistere conduttori a differenti tensioni anche se dotati di isolamento.

Quando sia necessario installare circuiti a tensioni diverse a brevissima distanza, è opportuno avere un isolamento doppio o rinforzato. In questo senso un separatore di materiale plastico è un rafforzativo dell'isolamento. Nelle separazioni di tipo elettromagnetico è necessario utilizzare cavi provvisti di guaina metallica o cavi inseriti in contenitori schermati. In questo caso la canalizzazione con separazione di circuiti consente l'alloggiamento del cavo schermato isolato dagli altri circuiti (ciò per garantire un ulteriore livello di protezione). Tutti i sistemi per installazione Arnocanali sono predisposti per la separazione dei circuiti con differenti scomparti in funzione delle dimensioni e tipologie del canale.



Resistenza ai raggi UV

Un impianto di canalizzazione deve garantire, nel tempo, non solo i principali requisiti di sicurezza e funzionalità ma anche la costanza di finitura estetica evitando cambiamenti di colore. A tal proposito abbiamo ottimizzato il comportamento dei nostri prodotti in PVC ai raggi UV. I nostri prodotti raggiungono risultati eccellenti per assicurare la costanza di colore nel tempo. In particolare lo scostamento delta E è stato il seguente.

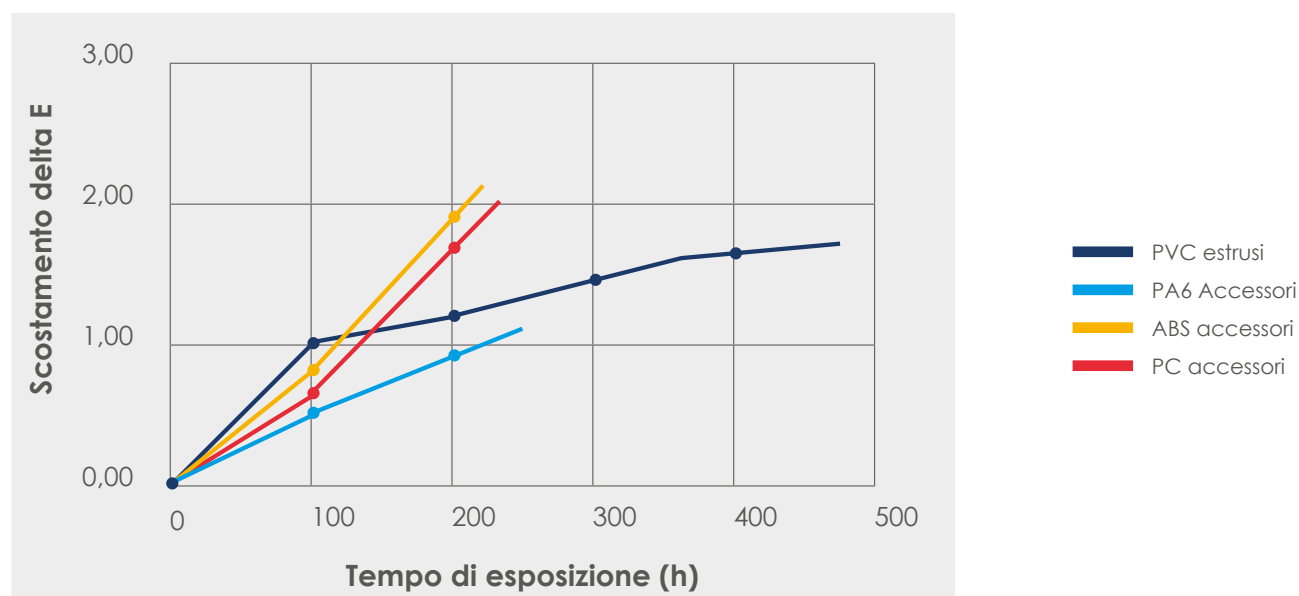

Caratteristiche di torrette e colonne

Caratteristiche in funzione dei requisiti richiesti dalle Norme EN 50085-2-2, EN50085-2-4 e EN6070-23

Parametro	Riferimento	Classificazione			
		TWIN monofacciale	TWIN bifacciale	TORA	TWIST
Normativa di riferimento		EN 50085-1			EN50085-2-2
Materiale	6.1	Materiale metallico	Materiale metallico	Non metallico	Non metallico
Resistenza agli urti durante l'installazione e uso	6.2	5J (IK08)	5J (IK08)	5J (IK08)	5J (IK08)
Temperatura minima di immagazzinamento	6.3 (tab.1)	-25°C	-25°C	-25°C	-25°C
Temperatura minima di installazione e utilizzo	6.3 (tab.2)	-25°C	-25°C	-25°C	-25°C
Temperatura massima di utilizzo	6.3 (tab.3)	+60°C	+60°C	+60°C	+60°C
Resistenza alla propagazione della fiamma	6.4	Non propagante la fiamma	Non propagante la fiamma	Non propagante la fiamma	Non propagante la fiamma
Continuità elettrica	6.5	Con continuità elettrica	Con continuità elettrica	Senza continuità elettrica	Senza continuità elettrica
Proprietà elettriche isolanti	6.6	Senza proprietà elettrica isolante	Senza proprietà elettrica isolante	Con proprietà elettrica isolante (750V)	Con proprietà elettrica isolante (750V)
Grado di protezione assicurato dall'involucro	6.7	IP40	IP40	IP40	IP52 IP40 IP20
Modalità di apertura del coperchio	6.9	Apribile solo con attrezzo	Apribile solo con attrezzo	Apribile solo con attrezzo	Apribile solo con attrezzo
Separazione di protezione elettrica	6.10	Con separatore	Con separatore	Con separatore	Con segregazione
Normativa di riferimento		EN 50085-2-4			EN60670-23
Classificazione del CTS secondo trattamento del pavimento	6.101	Tattamento umido del pavimento	Tattamento umido del pavimento	Tattamento umido del pavimento	Tattamento umido del pavimento
Resistenza al carico verticale applicato su piccola superficie	6.102	N.A	N.A	N.A	1500 N
Resistenza al carico verticale applicato su grande superficie	6.103	N.A	N.A	N.A	3000 N
Classificazione del CTS secondo le posizioni di installazione	-	Colonna e torretta per il montaggio sul piano orizzontale del pavimento	Colonna e torretta per il montaggio sul piano orizzontale del pavimento	Torretta per il montaggio sul piano orizzontale del pavimento	Torretta per il montaggio incassato nel pavimento

Caratteristiche di minicanali e canali

Di seguito le caratteristiche in funzione dei requisiti richiesti dalle Norme EN 50085-1, EN50085-2-1

Parametro	Riferimento	Classificazione		
		MINIKAPPA (KDU, K, LCD)	KAPPA (K)	SPACE (BR)
Normativa di riferimento		EN 50085-1		
Materiale del CTS	6.1	Non metallico	Non metallico	Non metallico
Resistenza agli urti durante l'installazione e l'utilizzo	6.2	2J (IK07)	5J (IK08)	5J (IK08)
Temperatura minima di immagazzinamento e trasporto	6.3 (tab.1)	-15°C	-45°C	-45°C
Temperatura minima di installazione e utilizzo	6.3 (tab.2)	-5°C	-5°C	-5°C
Temperatura massima di utilizzo	6.3 (tab.3)	+60°C	+60°C	+60°C
Resistenza alla propagazione della fiamma del CTS	6.4	Non propagante la fiamma	Non propagante la fiamma	Non propagante la fiamma
Continuità elettrica del CTS	6.5	Senza continuità elettrica	Senza continuità elettrica	Senza continuità elettrica
Proprietà elettriche isolanti del CTS	6.6	Con proprietà elettriche isolanti (750V)	Con proprietà elettriche isolanti (750V)	Con proprietà elettriche isolanti (750V)
Grado di protezione assicurato dall'involucro del CTS	6.7	IP40	IP40 (parete soffitto) IP20 (Sospensione)	IP40
Modalità di apertura del coperchio del CTS di accesso al sistema	6.9	Apribile solo con attrezzo	Apribile solo con attrezzo	Apribile solo con attrezzo
Separazione di protezione elettrica del CTS	6.10	Con separatore	Con separatore	Con separatore
Posizione di installazione prevista del CTS	6.101	A semi-incasso o montato sporgente sulla parete	A semi-incasso o montato sporgente sulla parete	A semi-incasso o montato sporgente sulla parete
		A semi-incasso o montato sporgente al soffitto	A semi-incasso o montato sporgente al soffitto	A semi-incasso o montato sporgente al soffitto
			⁽¹⁾ Montato distanziato dalla parete o dal soffitto usando i dispositivi di supporto	
Misure atte a prevenire il contatto tra liquidi e conduttori isolati con le parti attive per CTS montati a battiscopa in caso di trattamento umido del pavimento	6.102	⁽²⁾ Completamente dipendente dalle istruzioni del costruttore che limitano la posizione del CTS	⁽²⁾ Completamente dipendente dalle istruzioni del costruttore che limitano la posizione del CTS	⁽²⁾ Completamente dipendente dalle istruzioni del costruttore che limitano la posizione del CTS
Classificazione del CTS tipo 2 (distribuzione)	6.103	Tipo 2	Tipo 2	Tipo 2
Classificazione del CTS tipo 3 (installazione)		Tipo 3	Tipo 3	Tipo 3

(1) I canali idonei ad essere installati e classificati secondo il paragrafo 6.101.4 della norma, se sottoposti ad un carico di 0,1 kg/cm² di sezione utile per alloggiamento cavi, per metro lineare, devono presentare una flessione inferiore all'1% della distanza tra i supporti dichiarata dal costruttore. La freccia viene misurata a metà campata al centro della superficie inferiore e con l'elemento di giunzione al centro.

Caratteristiche dei canali

Di seguito le caratteristiche in funzione dei requisiti richiesti dalle Norme EN 50085-1, EN50085-2-1

Classificazione			
ALUSPACE (BU)	WING (KB, KC)	DOUBLE (KPS)	CORNER (EDK)
EN 50085-1			
Composto	Non metallico	Non metallico	Non metallico
5J (IK08)	5J (IK08)	5J (IK08)	5J (IK08)
-45°C	-25°C	-25°C	-25°C
-5°C	-5°C	-5°C	-5°C
+60°C	+60°C	+60°C	+60°C
Non propagante la fiamma	Non propagante la fiamma	Non propagante la fiamma	Non propagante la fiamma
Con continuità elettrica (impedenza lineare $\leq 0,04 \Omega/m$)	Senza continuità elettrica	Senza continuità elettrica	Senza continuità elettrica
Senza proprietà elettriche isolanti	Con proprietà elettriche isolanti (750V)	Con proprietà elettriche isolanti (750V)	Con proprietà elettriche isolanti (750V)
IP40	IP40	IP40	IP40
Apribile solo con attrezzo	Apribile solo con attrezzo	Apribile solo con attrezzo	Apribile solo con attrezzo
Con separatore	Con separatore	Con separatore	Con separatore
A semi-incasso o montato sporgente sulla parete	A semi-incasso o montato sporgente sulla parete	A semi-incasso o montato sporgente sulla parete	A semi-incasso o montato sporgente sulla parete
A semi-incasso o montato sporgente al soffitto	A semi-incasso o montato sporgente al soffitto	A semi-incasso o montato sporgente al soffitto	A semi-incasso o montato sporgente al soffitto
	(Solo Art. KB) Fissato alla parete e sostenuto dal pavimento		
⁽²⁾ Completamente dipendente dalle istruzioni del costruttore che limitano la posizione del CTS	(Art. KC) Completamente dipendente dalle istruzioni del costruttore che limitano la posizione del CTS	⁽²⁾ Completamente dipendente dalle istruzioni del costruttore che limitano la posizione del CTS	⁽²⁾ Completamente dipendente dalle istruzioni del costruttore che limitano la posizione del CTS
	(Art. KB) Dipendente dalle istruzioni del costruttore che limitano la posizione di installazione del CTS ⁽²⁾		
Tipo 2	Tipo 2	Tipo 2	Tipo 2
Tipo 3	Tipo 3	Tipo 3	Tipo 3

⁽²⁾ Secondo la Norma EN 50085-2-1 tutti i canali classificati secondo 6.102.2 devono essere installati in modo che le parti attive e i conduttori si trovino ad una distanza dal pavimento superiore a 10 mm.



Kablo VK

196

Canali da cablaggio in PVC
Pvc wiring ducts



Kablo VH

198

Canali da cablaggio
senza ALOGENI
Wiring ducts
Halogen free

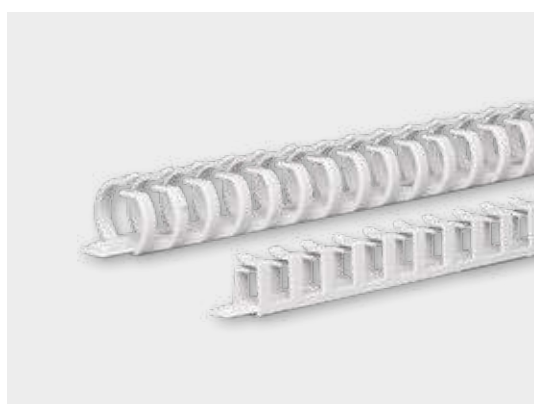

Kablo VF

204

Canaline flessibili con adesivo
senza ALOGENI
Flexible wiring ducts with adhesive tape
Halogen free



Kablo FLEX

204

Guaina trecciata estensibile
e spirale per il cablaggi elettrici
Expansible braided sleeves
and wiring harness spiral



Kablo RAIL

206

Guide metalliche in acciaio
Galvanized steel din rails



Kablo TOOL

209

Cesoie per canali da cablaggio
e guide metalliche
Wiring duct cutting tools
and steel rail cutting tool

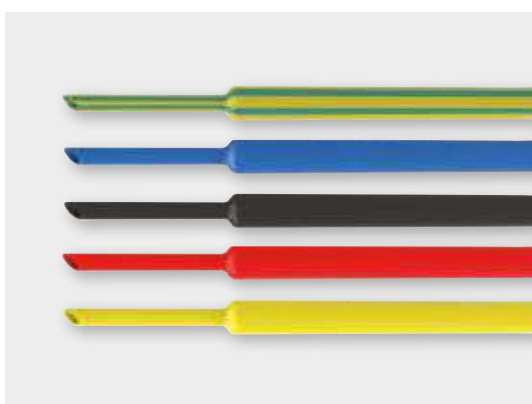

Thermo

210

Guaine termorestringenti in poliolefina
Crosslinked polyolefin heat shrink tubes



Walkable

218

Canali passacavi carrabili
Cable ramps system

KABLO

Sistemi di canali e accessori per il cablaggio di quadri elettrici

Wiring trunking systems and accessories for electrical panels

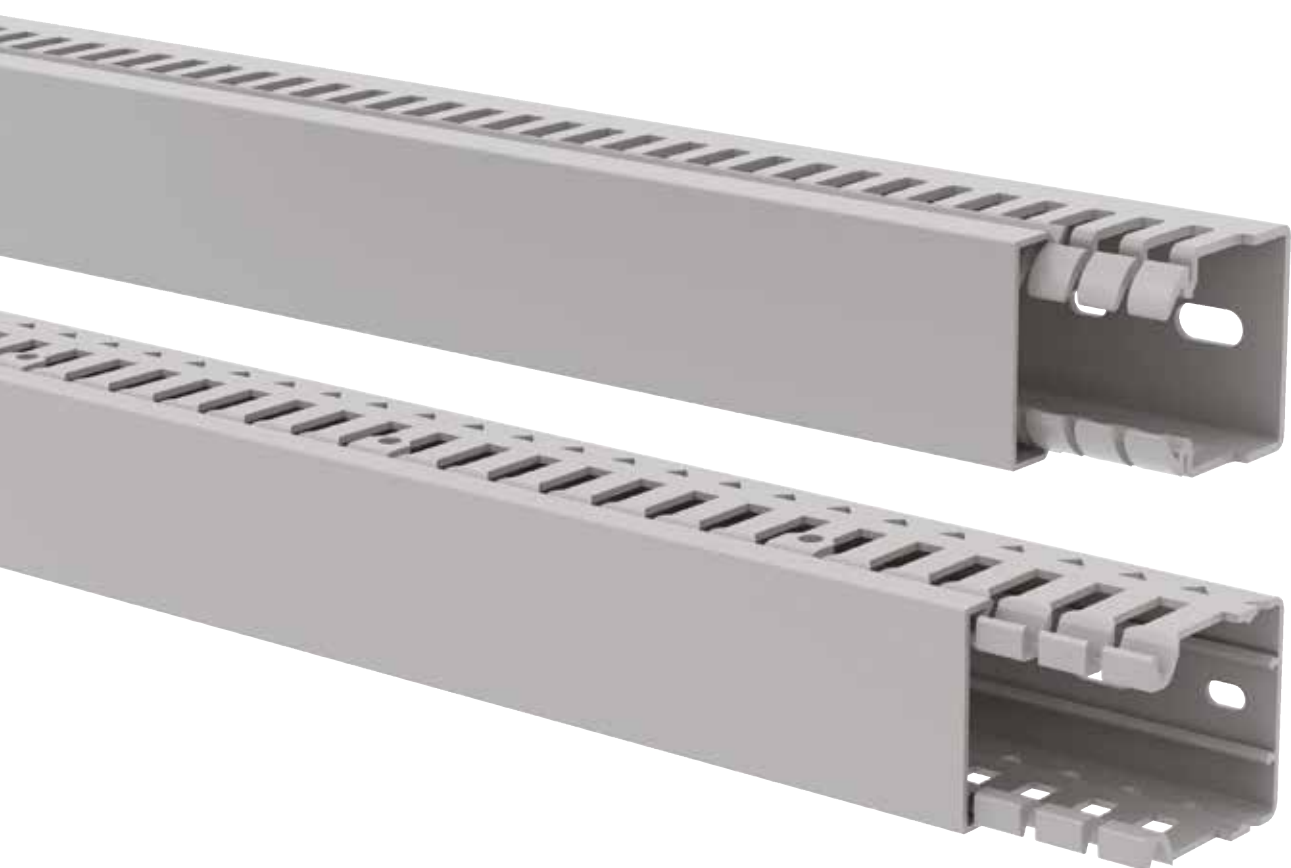

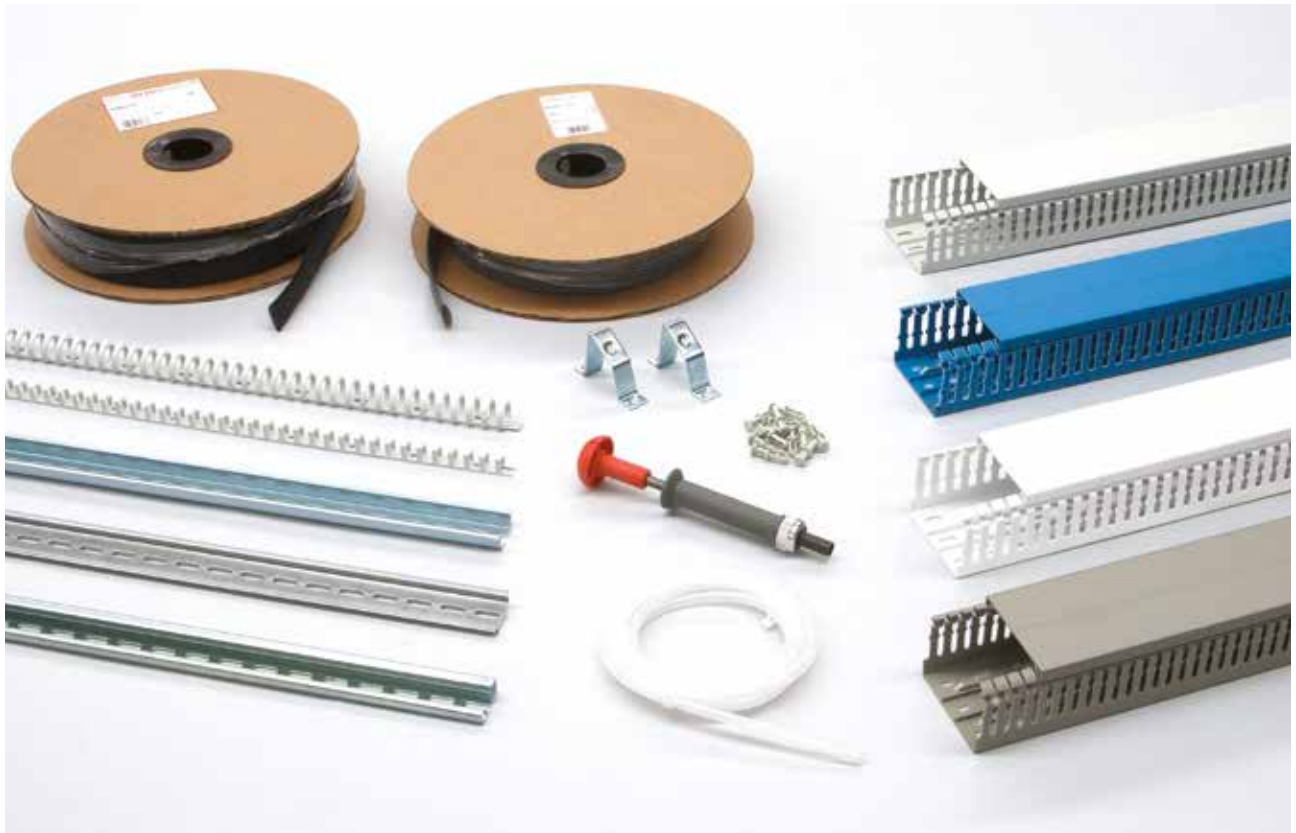

Caratteristiche Tecniche

- Canale in PVC e PC-ABS senza alogeni
- Canale lunghezza standard 2 metri
- Resistenza all'urto IK 08 (6J)
- Temperatura di utilizzo -15°C +60°C

Technical Features

- PVC trunkings and PC-ABS halogen free trunkings
- Standard length trunking 2 meters
- Impact resistance IK 08 (6J)
- Operating temperature -15°C +60°C

Riferimenti a Norme

- Conforme alla norma CEI EN 50085-2-3
- Conforme alla Direttiva RoHS 2015/863/EU
- Conforme alla Direttiva B.T. 2014/35/EU

Norms Reference

- Complies with standard CEI EN 50085-2-3
- Compliant with RoHS Directive 2015/863/EU
- Compliant with the Low Voltage Directive 2014/35/EU

Marchi e Certificazioni

- Marchio IMQ (V4K,V5K,V6K) Rif. n°CA02.02387
- Marchio UL (V4K,V5K,V6K,V6H) Rif. n°ZODZ2.E197662
- Marchio CSA (V5K,V6K,V6H) Rif. n°2326493
- Marchio VDE (V6K,V6H) Rif. n°40026398 / 40026400
- Marcatura CE

Marks and Certifications

- IMQ mark (V4K,V5K,V6K) Ref. n°CA02.02387
- UL mark (V4K,V5K,V6K,V6H) Ref. n°ZODZ2.E197662
- CSA mark (V5K,V6K,V6H) Ref. n°2326493
- VDE mark (V6K,V6H) Ref. n°40026398 / 40026400
- CE marking









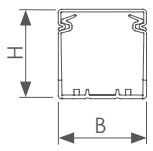

Colori disponibili

- Grigio RAL7030, Grigio RAL7035, Bianco RAL9003, Blu RAL5012

Available colours

- Grey RAL7030, Grey RAL7035, White RAL9003, Blue RAL5012

Canale da cablaggio in PVC PVC wiring ducts

					
Dimensioni Dimensions B x H	 Grigio RAL7030 Passo 10 mm Tranciatura 4,5 mm Lamella 5,5 mm Grey RAL7030 Step 10 mm Slot 4,5 mm Segment 5,5 mm	 Grigio RAL7030 Passo 12,5 mm Tranciatura 6 mm Lamella 6,5 mm Grey RAL7030 Step 12,5 mm Slot 6 mm Segment 6,5 mm	 Bianco RAL9003 Passo 12,5 mm Tranciatura 6 mm Lamella 6,5 mm White RAL9003 Step 12,5 mm Slot 6 mm Segment 6,5 mm	 Blu RAL5012 Passo 12,5 mm Tranciatura 6 mm Lamella 6,5 mm Blue RAL5012 Step 12,5 mm Slot 6 mm Segment 6,5 mm	 Canale chiuso Grigio RAL7030 Closed trunking Grey RAL7030
25x25 mm		V6K2525	V6K2525W	V6B2525	
40x25 mm		V6K2540	V6K2540W	V6B2540	
80x25 mm		V6K2580			
25x40 mm	V5K4025	V6K4025	V6K4025W	V6B4025	
30x40 mm		V6K4030			
40x40 mm	V5K4040	V6K4040	V6K4040W	V6B4040	V0K4040
60x40 mm	V5K4060	V6K4060	V6K4060W	V6B4060	V0K4060
80x40 mm	V5K4080	V6K4080	V6K4080W		
25x60 mm	V5K6025	V6K6025	V6K6025W	V6B6025	
30x60 mm		V6K6030			
40x60 mm	V5K6040	V6K6040	V6K6040W	V6B6040	V0K6040
60x60 mm	V5K6060	V6K6060	V6K6060W	V6B6060	V0K6060
80x60 mm	V5K6080	V6K6080	V6K6080W	V6B6080	V0K6080
100x60 mm	V5K60100	V6K60100	V6K60100W	V6B60100	V0K60100
120x60 mm		V6K60120	V6K60120W		
25x80 mm	V5K8025	V6K8025	V6K8025W	V6B8025	
30x80 mm		V6K8030			
40x80 mm	V5K8040	V6K8040	V6K8040W	V6B8040	V0K8040
60x80 mm	V5K8060	V6K8060	V6K8060W	V6B8060	V0K8060
80x80 mm	V5K8080	V6K8080	V6K8080W	V6B8080	V0K8080
100x80 mm	V5K80100	V6K80100	V6K80100W	V6B80100	V0K80100
120x80 mm	V5K80120	V6K80120	V6K80120W	V6B80120	V0K80120
25x100 mm					
30x100 mm		V6K10030	V6K10030W		
40x100 mm	V5K10040	V6K10040	V6K10040W		
60x100 mm	V5K10060	V6K10060	V6K10060W	V6B10060	
80x100 mm	V5K10080	V6K10080	V6K10080W	V6B10080	
100x100 mm	V5K100100	V6K100100	V6K100100W	V6B100100	
120x100 mm					

Per informazioni tecniche vedere pagine 200-203
 For technical features see pages 200-203

Coperchio di ricambio per V5K e V6K Grigio RAL7030 Replacement cover for V5K and V6K Grey RAL7030	Coperchio di ricambio per V5K e V6K Bianco RAL9003 Replacement cover for V5K and V6K White RAL9003	Coperchio di ricambio per V5K e V6K Blu RAL5012 Replacement cover for V5K and V6K Blue RAL5012	Grigio RAL7030 Passo 12,5 mm Tranciatura 6 mm Lamella 6,5 mm Grey RAL7030 Step 12,5 mm Slot 6 mm Segment 6,5 mm	Coperchio di ricambio per V4K Grigio RAL7030 Replacement cover for V4K Grey RAL7030
V25K	V25KW	V25KB	V4K2525	VC25
V40	V40W	V40B	V4K2540	VC40
V80				
V25	V25W	V25B	V4K4025	VC25
V30				
V40	V40W	V40B	V4K4040	VC40
V60	V60W	V60B	V4K4060	VC60
V80	V80W	V80B	V4K4080	VC80
V25	V25W	V25B	V4K6025	VC25
V30				
V40	V40W	V40B	V4K6040	VC40
V60	V60W	V60B	V4K6060	VC60
V80	V80W	V80B	V4K6080	VC80
V100	V100W	V100B	V4K60100	VC100
V120	V120W	V120B	V4K60120	VC120
V25	V25W	V25B	V4K8025	VC25
V30				
V40	V40W	V40B	V4K8040	VC40
V60	V60W	V60B	V4K8060	VC60
V80	V80W	V80B	V4K8080	VC80
V100	V100W	V100B	V4K80100	VC100
V120	V120W	V120B	V4K80120	VC120
			V4K10025	VC25
V30				
V40	V40W	V40B	V4K10040	VC40
V60	V60W	V60B	V4K10060	VC60
V80	V80W	V80B	V4K10080	VC80
V100	V100W	V100B	V4K100100	VC100
			V4K100120	VC120

Canale da cablaggio senza ALOGENI
Wiring duct HALOGEN free

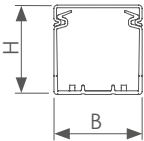
				
Dimensioni Dimensions B x H	 Grigio RAL7035 Passo 12,5 mm Tranciatura 6 mm Lamella 6,5 mm Grey RAL7035 Step 12,5 mm Slot 6 mm Segment 6,5 mm	 Blu RAL5012 Passo 12,5 mm Tranciatura 6 mm Lamella 6,5 mm Blu RAL5012 Step 12,5 mm Slot 6 mm Segment 6,5 mm	 Coperchio di ricambio Grigio RAL7035 Replacement cover Grey RAL7035	 Canale chiuso Grigio RAL7035 Closed trunking Grey RAL7035
25x25 mm	V6H2525		V25HK	
40x25 mm	V6H2540		V40H	
25x40 mm	V6H4025		V25H	
40x40 mm	V6H4040	V6HB4040	V40H	VOH4040
60x40 mm	V6H4060		V60H	VOH4060
80x40 mm	V6H4080		V80H	
25x60 mm	V6H6025		V25H	
40x60 mm	V6H6040		V40H	VOH6040
60x60 mm	V6H6060		V60H	VOH6060
80x60 mm	V6H6080		V80H	VOH6080
100x60 mm	V6H60100		V100H	VOH60100
120x60 mm	V6H60120		V120H	
25x80 mm	V6H8025		V25H	
40x80 mm	V6H8040	V6HB8040	V40H	
60x80 mm	V6H8060	V6HB8060	V60H	
80x80 mm	V6H8080	V6HB8080	V80H	
100x80 mm	V6H80100		V100H	
120x80 mm	V6H80120		V120H	
40x100 mm	V6H10040 <i>NEW</i>		V60H	
60x100 mm	V6H10060		V80H	
80x100 mm	V6H10080		V100H	
100x100 mm	V6H100100	V6HB100100 <i>NEW</i>	V100H	

Per informazioni tecniche vedere pagine 200-203
For technical features see pages 200-203

I3 F2 Classe di emissione fumi dei canali V6H, V6HB, V0H I3 F2 Smoke emission class of the channels V6H, V6HB, V0H

Per soddisfare i più alti standard di sicurezza la Arnocanali mette a disposizione della clientela le nuove canaline da cablaggio in PC-ABS esente da alogeni, soluzione ideale quando la sicurezza è un requisito fondamentale. In caso di incendio, infatti, questo materiale, oltre a impedire la propagazione delle fiamme, emette gas a bassissimo contenuto di sostanze tossiche e fumi non opachi, che non ostacolano la visuale. I canali V6H e V0H sono conformi alla Norma CEI 23-22, DIN 43659 (foratura canale), VDE 0472 (halogen free), UL 94 V0 (autoestinguenza).

I maggiori campi di applicazione dei prodotti Halogen free sono i seguenti:

- Ambienti in cui si radunano numerose persone (cinema, teatri, scuole, ecc), aree con particolari requisiti di sicurezza (sotterranei, metropolitane, militare, navale, ecc), impianti industriali (petrolchimici, piattaforme off-shore, centrali, ecc), mezzi di trasporto (metro, treni, navi, aerei, ecc).

In order to conform to the highest standards for the safety Arnocanali proposes to the customers the new PC-ABS halogen-free wiring ducts, which is the ideal solution in those cases where security is a fundamental requirement. Indeed, in case of fire, such material, besides avoiding the spread of flames, shoots a gas having a very low content of toxicants, as well as fumes which do not hinder the view. V6H and V0H conform to the norm CEI 23-22, DIN 43659 (trunking punching), VDE 0472 (halogen free), UL 94 V0 (self extinguishing).

The most important sectors where the halogen-free products can be used are:

- Places where many people gather frequently: (cinemas, theatres, schools), places requiring a high standard of security (undergrounds, subway stations, military, naval), industrial plants (petrochemical, off-shore platforms, power stations), means of transport (subways, trains, boats, planes).

Traversa reggicavo Cable clamp

Per canali: V5K, V6K e V6H
Materiale: policarbonato **senza ALOGENI**
For ducts: V5K, V6K and V6H
Material: polycarbonate **HALOGEN free**

Articolo Item	VTK6
	

Spessore canali da cablaggio Thickness of wiring trunkings

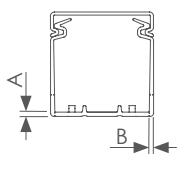
 Altezza canale Trunking Height	V4K		V5K V6K V6B V0K		V6H V6HB V0H	
	A mm	B mm	A mm	B mm	A mm	B mm
25 mm	1,4	1,4	1,4	1,3	1,4	1,3
40 mm	1,4	1,4	1,5	1,4	1,5	1,4
60 mm	1,8	1,8	1,7	1,6	1,7	1,6
80 mm	1,8	1,8	2,1	2,0	2,1	2,0
100 mm	2,2	2,2	2,5	2,4	2,5	2,4
120 mm	2,5	2,5	-	-	-	-

Sezione utile e capacità di contenenza cavi Useful section and cable containment capacity

N. Conduttori inseribili tipo H07V-U/R/K N. of insertable cables type H07V-U/R/K										
V4K	V5K	V6K	V6B	V6H	V6HB	Dimensioni Dimension	Sezione utile Cross section	1 mm ²	1,5 mm ²	2,5 mm ²
						B x H mm	mm ²			
V4K2525		V6K2525	V6B2525	V6H2525		25x25	410	39	28	19
V4K2540		V6K2540	V6B2540	V6H2540		40x25	747	71	51	35
		V6K2580				80x25	1.647	156	113	78
V4K4025	V5K4025	V6K4025	V6B4025	V6H4025		25x40	701	66	48	33
		V6K4030				30x40	852	78	56	39
V4K4040	V5K4040	V6K4040	V6K4040	V6H4040	V6HB4040	40x40	1.227	116	84	58
V4K4060	V5K4060	V6K4060	V6K4060	V6H4060		60x40	1.925	183	132	92
V4K4080	V5K4080	V6K4080		V6H4080		80x40	2.715	258	187	129
V4K6025	V5K6025	V6K6025	V6B6025	V6H6025		25x60	1.141	108	78	54
		V6K6030				30x60	1.392	132	96	66
V4K6040	V5K6040	V6K6040	V6B6040	V6H6040		40x60	1.967	187	135	94
V4K6060	V5K6060	V6K6060	V6B6060	V6H6060		60x60	3.105	295	214	148
V4K6080	V5K6080	V6K6080	V6B6080	V6H6080		80x60	4.255	405	293	203
V4K60100	V5K60100	V6K60100	V6B60100	V6H60100		100x60	5.405	514	372	258
V4K60120	V5K60120	V6K60120		V6H60120		120x60	6.320	601	435	302
V4K8025	V5K8025	V6K8025	V6B8025	V6H8025		25x80	1.581	150	109	75
		V6K8030				30x80	1.932	184	133	92
V4K8040	V5K8040	V6K8040	V6B8040	V6H8040	V6HB8040	40x80	2.707	257	186	129
V4K8060	V5K8060	V6K8060	V6B8060	V6H8060	V6HB8060	60x80	4.245	404	292	203
V4K8080	V5K8080	V6K8080	V6B8080	V6H8080	V6HB8080	80x80	5.795	551	399	277
V4K80100	V5K80100	V6K80100	V6B80100	V6H80100		100x80	7.345	699	506	351
V4K80120	V5K80120	V6K80120	V6B80120	V6H80120		120x80	8.895	847	613	425
V4K10025						25x100	1.977	188	136	95
		V6K10030				30x100	2.471	235	170	118
V4K10040	V5K10040	V6K10040				40x100	3.446	328	237	164
V4K10060	V5K10060	V6K10060	V6B10060	V6H10060		60x100	5.385	512	371	257
V4K10080	V5K10080	V6K10080	V6B10080	V6H10080		80x100	7.335	698	505	350
V4K100100	V5K100100	V6K100100	V6B100100	V6H100100		100x100	9.285	884	640	444
V4K100120						120x100	11.142	1.060	768	532

6 motivi per scegliere i canali da cablaggio V5K/V6K/V6H

- 1 - Chiusura del coperchio facilitata
- 2 - Asola per inserimento fascette sul fondo del canale
- 3 - Costole d'irrigidimento sul fondo del canale
- 4 - Zigrinatura per una maggiore aderenza con adesivi
- 5 - Prerottura interna ed esterna della lamella e del fondo
- 6 - Coperchio con coestruso morbido antiscivolo sui canali V5K e V6K

6 grounds to choose the wiring ducts V5K/V6K/V6H

- 1 - Easiness closing cover
- 2 - Loops on the bottom to insert cable ties
- 3 - Stiffen up guide on the bottom of trunking
- 4 - Milling for more grip with adhesive
- 5 - Internal and external precutted segment and bottom
- 6 - Cover with non-slip soft coextruded on the V5K and V6K ducts

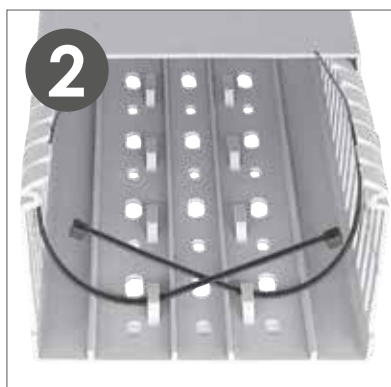

Dimensioni tranciatura dei fianchi del canale Wall punching dimensions of the ducts

V4K				
Altezza 25 mm Height 25 mm	Altezza 40 mm Height 40 mm	Altezza 60 mm Height 60 mm	Altezza 80 mm Height 80 mm	Altezza 100 mm Height 100 mm
V5K				
Altezza 25 mm Height 25 mm	Altezza 40 mm Height 40 mm	Altezza 60 mm Height 60 mm	Altezza 80 mm Height 80 mm	Altezza 100 mm Height 100 mm
V6K - V6B - V6H				
Altezza 25 mm Height 25 mm	Altezza 40 mm Height 40 mm	Altezza 60 mm Height 60 mm	Altezza 80 mm Height 80 mm	Altezza 100 mm Height 100 mm

Schema di foratura delle basi Bases punching scheme

V4K			
Larghezza 25, 40 mm Width 25, 40 mm	Larghezza 60 mm Width 60 mm	Larghezze 80, 100 mm Width 80, 100 mm	Larghezze 120 mm Width 120 mm
V5K, V6K, V6B, VOK			
Larghezza 25, 40 mm Width 25, 40 mm	Larghezza 60 mm Width 60 mm	Larghezze 80, 100 mm Width 80, 100 mm	Larghezze 120 mm Width 120 mm
V6H, V6HB, V0H			
Larghezza 25, 40 mm Width 25, 40 mm	Larghezza 60 mm Width 60 mm	Larghezze 80, 100 mm Width 80, 100 mm	Larghezze 120 mm Width 120 mm

Canalina flessibile con adesivo Flexible wire duct with adhesive

<p>Materiale: Poliammide Senza Alogeni Colore: Grigio RAL7030 Temperatura d'esercizio: -25°C +90°C Inflammabilità: UL94 V0 Certificazioni: UL, CSA Conformità: CE, RoHS 2015/863/EU</p> <p>Material: Polyamide Halogen Free Colour: Grey RAL7030 Working temperature: -25°C +90°C Flammability: UL94 V0 Certifications: UL, CSA Compliance: CE, RoHS 2015/863/EU</p>							<p>art. V10R</p> <p>art. V20R V30R V40R</p>
Articolo Item	Lunghezza Length	Sezione Section	Dimensioni Dimensions				
			A mm	B mm	C mm	D mm	
V10R	250 mm	82 mm ²	10	10	8	4,5	
V20R	500 mm	300 mm ²	20	20	8	4,5	
V30R	500 mm	620 mm ²	30	30	8	4,5	
V40R	500 mm	1.050 mm ²	40	40	8	4,5	



Spirale per cablaggio cavi Wiring harness spiral

<p>Materiale: Polietilene Colore: Trasparente Temperatura d'esercizio: -40°C +60°C Inflammabilità: UL94 HB Conformità: CE, RoHS 2015/863/EU</p> <p>Material: Polyethylene Colour: Transparent Working temperature: -40°C +60°C Flammability: UL94 HB Compliance: CE, RoHS 2015/863/EU</p>					
Articolo Item	Lunghezza rotolo Roll length	Dimensioni Dimensions			
		A mm	B mm	C mm	
VS6	10 m	6	4	1	
VS8	10 m	8	6	1	
VS10	10 m	10	7,5	1,25	
VS12	10 m	12	9	1,5	
VS16	10 m	16	13	1,5	
VS20	10 m	20	16	2	
VS25	10 m	25	20	2,5	



Guaina trecciata estensibile Expansible braided sleeve

Materiale: Poliestere Senza Alogeni Colore: Nero, Grigio Diametro filato: 0,22 mm Temperatura d'esercizio: -40°C +150°C Inflammabilità: UL94 V2 Conformità: CE, RoHS 2015/863/EU Normativa: DIN 5510 parte 2		Material: Polyester Halogen Free Colour: Black, Grey Filament diameter: 0,22 mm Working temperature: -40°C +150°C Flammability: UL94 V2 Compliance: CE, RoHS 2015/863/EU Standard: DIN 5510 parte 2		
Articolo Item		Dimensioni Dimensions	Estensione Extension Ø	Lunghezza rotolo Roll length
Nero Black	Grigio Grey			
GNB05PE	GGB05PE	Ø5 mm	Da 3 a 10 mm From 3 to 10 mm	100 m
GNB10PE	GGB10PE	Ø10 mm	Da 8 a 18 mm From 8 to 18 mm	100 m
GNB15PE	GGB15PE	Ø15 mm	Da 10 a 22 mm From 10 to 22 mm	50 m
GNB20PE	GGB20PE	Ø20 mm	Da 15 a 30 mm From 15 to 30 mm	50 m
GNB25PE	GGB25PE	Ø25 mm	Da 23 a 38 mm From 23 to 38 mm	50 m
GNB30PE	GGB30PE	Ø30 mm	Da 28 a 49 mm From 28 to 49 mm	50 m
GNB40PE	GGB40PE	Ø40 mm	Da 34 a 60 mm From 34 to 60 mm	50 m
GNB50PE	GGB50PE	Ø50 mm	Da 45 a 80 mm From 45 to 80 mm	50 m



Guaina trecciata estensibile con Velcro Expansible braided sleeve with Velcro

Materiale guaina: Poliestere Materiale Velcro: Poliammide Colore: Nero Temperatura d'esercizio: -50°C +150°C Inflammabilità: VW-1 Conformità: CE, RoHS 2015/863/EU		Wrap material: Polyester Velcro material: Polyamide Colour: Black Working temperature: -50°C +150°C Flammability: VW-1 Compliance: CE, RoHS 2015/863/EU	
Articolo Item		Dimensioni Dimensions	Estensione Extension Ø
MGE30	Bobina da 25 m Reel 25 m		
MGE30	Bobina da 25 m Reel 25 m	Ø30 mm	Da 75 a 100 mm From 75 to 100 mm
MGE50	Bobina da 25 m Reel 25 m	Ø50 mm	Da 90 a 120 mm From 90 to 120 mm
MGE30B	Bliester 1,5 m Blister 1,5 m		
MGE30B	Bliester 1,5 m Blister 1,5 m	Ø30 mm	Da 75 a 100 mm From 75 to 100 mm
MGE50B	Bliester 1,5 m Blister 1,5 m		
MGE50B	Bliester 1,5 m Blister 1,5 m	Ø50 mm	Da 90 a 120 mm From 90 to 120 mm



Guide metalliche in acciaio elettrozincato Metallic rails in electrogalvanized steel



<p>Materiale: Acciaio Trattamento: Zincatura elettrolitica e passivazione Dimensione asole: 18x5 mm con passo 25 mm Lunghezza guide: 2.000 mm Conformità: CE, RoHS 2015/863/EU Normativa: CEI EN 60715</p> <p>Material: Steel Treatment: Electrogalvanized and passivation Slot size: 18x5 mm with 25 mm pitch Rails length: 2.000 mm Compliance: CE, RoHS 2015/863/EU Standard: CEI EN 60715</p>								
Sezione Section	Articolo Item	Modello Model	Fondo Bottom	Dimensioni Dimensions				
				A mm	B mm	C mm	D mm	E mm
	534-2	G1	Chiuso Closed	32	15	1,5	5	18
	534LO-2	G1F	Forato Slotted	32	15	1,5	5	18
	536-2	OMEGA 3	Chiuso Closed	35	7,5	1	5	18
	536LO-2	OMEGA 3F	Forato Slotted	35	7,5	1	5	18
	537-2	OMEGA 3A	Chiuso Closed	35	15	1,5	5	18
	537LO-2	OMEGA 3AF	Forato Slotted	35	15	1,5	5	18



Staffa di supporto inclinata per guide metalliche Inclined support bracket for metallic rails



<p>Materiale: Acciaio Trattamento: Zincatura elettrolitica e passivazione Conformità: CE, RoHS 2015/863/EU Normativa: CEI EN 60715</p> <p>Material: Steel Treatment: Electrogalvanized and passivation Compliance: CE, RoHS 2015/863/EU Standard: CEI EN 60715</p>						
Articolo Item	Fori fissaggio Fixing holes	Filettatura foro Hole thread	A mm	B mm	C mm	D mm
752	Ø7 mm	M6	7,4	5	1,9	3,7



Morsetto di terra per guide metalliche Earthing clamp for metal rails



<p>Materiale morsetto: Ottone Materiale viti: Acciaio zincato Conformità: CE, RoHS 2015/863/EU Normativa: CEI EN 60715</p> <p>Clamp material: Brass Screw material: Galvanized steel Compliance: CE, RoHS 2015/863/EU Standard: CEI EN 60715</p>					
Articolo Item	Foro cavi Cable hole	Sezione cavo Cable section			
BTM	1 x Ø5,2 mm	Max 16 mm ²			

Applicarivetti Rivets applicator



<p>Adatto per: Fissaggio canali da cablaggio Materiale: Poliammide e Alluminio Conformità: CE, RoHS 2015/863/EU</p> <p>Suitable for: Fixing of wiring ducts Material: Polyamide and Aluminium Compliance: CE, RoHS 2015/863/EU</p>							
Articolo Item	Per rivetti For rivets						
VR140	Ø4 mm						
VR160	Ø6 mm						

Rivetti in plastica Plastic rivets



<p>Adatti per: Fissaggio di canali da cablaggio Materiale: Nylon Conformità: CE, RoHS 2015/863/EU</p> <p>Suitable for: Fixing of wiring ducts Material: Nylon Compliance: CE, RoHS 2015/863/EU</p>							
Articolo Item	Dimensione Dimension						
VRV40	Ø 4 mm						
VRV60	Ø 6 mm						

Viti autoperforanti Self drilling screws



<p>Adatte per: Fissaggio di canali da cablaggio Materiale: Acciaio Inox e Nylon Conformità: CE, RoHS 2015/863/EU</p> <p>Suitable for: Fixing of wiring ducts Material: Stainless steel / Nylon Compliance: CE, RoHS 2015/863/EU</p>					
Articolo Item	Dimensione Dimension				
V7900	Ø4,2x13 mm				

Cesoia per taglio pareti canali Shearing tool for wall ducts



<p>Adatta per: taglio delle pareti dei canali Materiale: Acciaio Conformità: CE, RoHS 2015/863/EU Accessori: con custodia e cacciavite a taglio</p> <p>Suitable for: cutting the walls of the ducts Material: Steel Compliance: CE, RoHS 2015/863/EU Accessories: with case and screwdriver</p>	Articolo Item	
	V910	

Cesoia taglio canali Cutting tool



<p>Adatta per: taglio di canali max larghezza 120 mm Materiale: Acciaio Conformità: CE, RoHS 2015/863/EU</p> <p>Suitable for: cutting of ducts max width 120 mm Material: Steel Compliance: CE, RoHS 2015/863/EU</p>	
Articolo Item	
KTC120	
KTC120L	lama di ricambio replacement blade

Forbici taglio canali Cutting shears



<p>Adatta per: Taglio di canali max larghezza 60 mm Materiale: Acciaio Conformità: CE, RoHS 2015/863/EU</p> <p>Suitable for: Cutting of ducts max width 60 mm Material: Steel Compliance: CE, RoHS 2015/863/EU</p>	
Articolo Item	
KTC	
KTCL	lama di ricambio replacement blade

Paralama di ricambio Replacement protection



<p>Per cesoia: VTC125B Materiale: Acciaio Conformità: CE, RoHS 2015/863/EU</p> <p>For cutting: VTC125B Material: Steel Compliance: CE, RoHS 2015/863/EU</p>	
Articolo Item	
VTC125PL	

Lama di ricambio Replacement blade



<p>Per cesoia: VTC125B Materiale: Acciaio Inox Conformità: CE, RoHS 2015/863/EU</p> <p>For cutting: VTC125B Material: Stainless Steel Compliance: CE, RoHS 2015/863/EU</p>	
Articolo Item	
VTC125L	









Cesoia da banco per canali da cablaggio Bench mounting wiring duct cutting tool

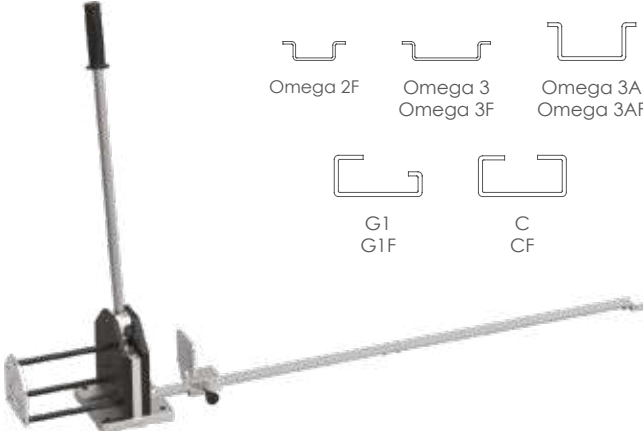

<p>Articolo: VTC125B Materiale: Acciaio e Alluminio Dimensione: 1340x290x810 mm Peso cesoia e vassoio: 19 Kg Larghezza max taglio: 125 mm Lunghezza max taglio: 1.000 mm Scala graduata: Metrica e pollici Conformità: CE, RoHS 2015/863/EU</p> <p>Item: VTC125B Material: Steel and Aluminium Dimensions: 1340x290x810 mm Shear and tray weight: 19 Kg Max cutting width: 125 mm Max cutting length: 1.000 mm Graduated scale: Metric and Inches Compliance: CE, RoHS 2015/863/EU</p>	 <ul style="list-style-type: none"> • Non produce scarto e polvere • La lama può essere sostituita o affilata • It does not produce waste and dust • The blade can be replaced or re-sharpened
--	--

Cesoia da banco per guide DIN Bench mounting DIN rail cutting tool

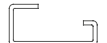

Caratteristiche tecniche Technical features	Dettagli immagine Image details
<p>Articolo: VTG-2 Materiale: Acciaio e Alluminio Dimensione cesoia: 1350x150x710 mm Lunghezza asta graduata: 1.000 mm Peso cesoia e asta graduata: 10 Kg Lunghezza max taglio: 1.000 mm Scala graduata: Metrica e pollici Conformità: CE, RoHS 2015/863/EU</p> <p>Item: VTG-2 Material: Steel and Aluminium Cutting size: 1350x150x710 mm Graduated rod length: 1.000 mm Cutting weight and graduated rod: 10 Kg Max cutting length: 1.000 mm Graduated scale: Metric and Inches Compliance: CE, RoHS 2015/863/EU</p>	 <div style="display: flex; justify-content: space-around; align-items: center;"> <div style="text-align: center;">  Omega 3 Omega 3F </div> <div style="text-align: center;">  Omega 3A Omega 3AF </div> </div>
<p>Articolo: VTG-5 NEW Materiale: Acciaio e Alluminio Dimensione cesoia: 1350x150x710 mm Lunghezza asta graduata: 1.000 mm Peso cesoia e asta graduata: 11 Kg Lunghezza max taglio: 1.000 mm Scala graduata: Metrica e pollici Conformità: CE, RoHS 2015/863/EU</p> <p>Item: VTG-5 Material: Steel and Aluminium Cutting size: 1350x150x710 mm Graduated rod length: 1.000 mm Cutting weight and graduated rod: 11 Kg Max cutting length: 1.000 mm Graduated scale: Metric and Inches Compliance: CE, RoHS 2015/863/EU</p>	 <div style="display: flex; justify-content: space-around; align-items: center;"> <div style="text-align: center;">  Omega 2F </div> <div style="text-align: center;">  Omega 3 Omega 3F </div> <div style="text-align: center;">  Omega 3A Omega 3AF </div> </div> <div style="display: flex; justify-content: space-around; align-items: center; margin-top: 10px;"> <div style="text-align: center;">  G1 G1F </div> <div style="text-align: center;">  C CF </div> </div>

THERMO

Guaine termorestringenti in poliolefina irradiata
senza alogeni

Heat shrink tubes of crosslinked polyolefin
halogen-free





Caratteristiche Tecniche

- Guaine termorestringenti in poliolefina irradiata
- Materiale senza alogeni
- Materiale autoestinguente
- Ottima resistenza meccanica e chimica
- Confezione in box, bobina o stecche
- Adatte per isolamento elettrico e usi generici

Technical Features

- Heat shrink tubing of crosslinked polyolefin
- Halogen-free material
- Self-extinguishing material
- Excellent mechanical and chemical resistance
- Packaged in box, reel or sticks
- Suitable for electrical insulation and general uses

Riferimenti a Norme

- Conforme alla Direttiva RoHS 2015/863/EU
- Conforme alla Direttiva B.T. 2014/35/EU

Norms Reference

- Compliant with RoHS Directive 2015/863/EU
- Compliant with the Low Voltage Directive 2014/35/EU

Marchi e Certificazioni

- Marcatura CE

Marks and Certifications

- CE marking

Colori disponibili

- Nero, Blu, Trasparente, Rosso, Giallo, Bianco, Giallo/Verde

Available colours

- Black, Blue, Transparent, Red, Yellow, White, Yellow/Green

Guaina termorestringente a parete sottile in rotolo Thin wall heat shrink tubing in roll

Materiale: Poliolefina irradiata
Rapporto di restringimento: 2:1
Temperatura d'esercizio: -55°C +135°C
Temperatura di restringimento: +110°C
Rigidità dielettrica: 20 kV/mm
Resistenza alla trazione: 19 MPa
Resistenza volume specifico: 10¹⁵ w x cm
Assorbimento di acqua: 0,3%
Conformità: CE, RoHS 2015/863/EU
Certificazioni: CSA, UL

Material: crosslinked polyolefin
Shrink ratio: 2:1
Operating temperature: -55°C +135°C
Shrinking temperature: +110°C
Dielectric strength: 20 kV/mm
Tensile strength: 19 MPa
Specific volume resistance: 10¹⁵ w x cm
Water absorption: 0.3%
Compliance: CE, RoHS 2015/863/EU
Certifications: CSA, UL



Articolo Item						Restringimento Shrinking			Lunghezza rotolo Roll Length
NERO BLACK	BLU BLUE	TRASPARENTE TRANSPARENT	ROSSO RED	GIALLO YELLOW	BIANCO WHITE	Prima Before	Dopo After		
						A mm	B mm	C mm	
GTM012	GTM012N	GTM012T	GTM012R	GTM012Y	GTM012W	1,2	0,6	0,4	10 m
GTM016	GTM016N	GTM016T	GTM016R	GTM016Y	GTM016W	1,6	0,8	0,4	10 m
GTM024	GTM024N	GTM024T	GTM024R	GTM024Y	GTM024W	2,4	1,2	0,5	10 m
GTM032	GTM032N	GTM032T	GTM032R	GTM032Y	GTM032W	3,2	1,6	0,5	10 m
GTM048	GTM048N	GTM048T	GTM048R	GTM048Y	GTM048W	4,8	2,4	0,5	8 m
GTM064	GTM064N	GTM064T	GTM064R	GTM064Y	GTM064W	6,4	3,2	0,6	6 m
GTM095	GTM095N	GTM095T	GTM095R	GTM095Y	GTM095W	9,5	4,8	0,6	5 m
GTM127	GTM127N	GTM127T	GTM127R	GTM127Y	GTM127W	12,7	6,4	0,6	5 m
GTM190	GTM190N	GTM190T	GTM190R	GTM190Y	GTM190W	19,0	9,5	0,8	4 m
GTM254	GTM254N	GTM254T	GTM254R	GTM254Y	GTM254W	25,4	12,7	0,9	3 m

Guaina termorestringente a parete sottile in stecche Thin wall heat shrink tubing in bars

<p>Materiale: Poliolefina irradiata Rapporto di restringimento: 2:1 Temperatura d'esercizio: -55°C +135°C Temperatura di restringimento: +110°C Rigidità dielettrica: 20 kV/mm Resistenza alla trazione: 19 MPa Resistenza volume specifico: 10¹⁵ w x cm Assorbimento di acqua: 0,3% Conformità: CE, RoHS 2015/863/EU Certificazioni: CSA, UL</p> <p>Material: crosslinked polyolefin Shrink ratio: 2:1 Operating temperature: -55°C +135°C Shrinking temperature: +110°C Dielectric strength: 20 kV/mm Tensile strength: 19 MPa Specific volume resistance: 10¹⁵ w x cm Water absorption: 0.3% Compliance: CE, RoHS 2015/863/EU Certifications: CSA, UL</p>	

Articolo Item					Restringimento Shrinking			Stecche da 1 m per busta Bar 1 m each bag
NERO BLACK	BLU BLUE	TRASPARENTE TRANSPARENT	ROSSO RED	GIALLO/VERDE YELLOW/GREEN	Prima Before	Dopo After		
					A mm	B mm	C mm	
GTS012-BL					1,2	0,6	0,4	25 p
GTS016-BL					1,6	0,8	0,4	25 p
GTS024-BL	GTS024N-BL	GTS024T-BL	GTS024R-BL	GTS024YV-BL	2,4	1,2	0,5	25 p
GTS032-BL	GTS032N-BL		GTS032R-BL		3,2	1,6	0,5	25 p
GTS048-BL	GTS048N-BL	GTS048T-BL	GTS048R-BL	GTS048YV-BL	4,8	2,4	0,5	25 p
GTS064-BL	GTS064N-BL		GTS064R-BL		6,4	3,2	0,6	10 p
GTS095-BL	GTS095N-BL	GTS095T-BL	GTS095R-BL	GTS095YV-BL	9,5	4,8	0,6	10 p
GTS127-BL	GTS127N-BL	GTS127T-BL	GTS127R-BL	GTS127YV-BL	12,7	6,4	0,6	10 p
GTS190-BL	GTS190N-BL		GTS190R-BL		19,0	9,5	0,8	10 p
GTS254-BL	GTS254N-BL		GTS254R-BL		25,4	12,7	0,9	10 p
GTS381-BL					38,1	19,0	1,0	10 p
GTS508-BL					50,8	25,4	1,1	5 p

Guaina termorestringente a parete sottile in bobina Thin wall heat shrink tubing on reel

Materiale: Poliolefina irradiata
Rapporto di restringimento: 2:1
Temperatura d'esercizio: -55°C +135°C
Temperatura di restringimento: +110°C
Rigidità dielettrica: 20 kV/mm
Resistenza alla trazione: 19 MPa
Resistenza volume specifico: 10¹⁵ w x cm
Assorbimento di acqua: 0,3%
Conformità: CE, RoHS 2015/863/EU
Certificazioni: CSA, UL

Material: crosslinked polyolefin
Shrink ratio: 2:1
Operating temperature: -55°C +135°C
Shrinking temperature: +110°C
Dielectric strength: 20 kV/mm
Tensile strength: 19 MPa
Specific volume resistance: 10¹⁵ w x cm
Water absorption: 0.3%
Compliance: CE, RoHS 2015/863/EU
Certifications: CSA, UL



Articolo Item				Restringimento Shrinking			Metri per bobina Meters each Reel
NERO BLACK	BLU BLUE	TRASPARENTE TRANSPARENT	GIALLO/VERDE YELLOW/GREEN	Prima Before	Dopo After		
				A mm	B mm	C mm	
GTB024	GTB024N	GTB024T	GTB024YV	2,4	1,2	0,5	150 m
GTB032	GTB032N	GTB032T	GTB032YV	3,2	1,6	0,5	150 m
GTB048	GTB048N	GTB048T	GTB048YV	4,8	2,4	0,5	75 m
GTB064	GTB064N	GTB064T	GTB064YV	6,4	3,2	0,6	75 m
GTB095	GTB095N	GTB095T	GTB095YV	9,5	4,8	0,6	75 m
GTB127	GTB127N	GTB127T	GTB127YV	12,7	6,4	0,6	50 m
GTB190	GTB190N	GTB190T	GTB190YV	19,0	9,5	0,8	30 m
GTB254	GTB254N	GTB254T	GTB254YV	25,4	12,7	0,9	30 m
GTB381	GTB381N	GTB381T	GTB381YV	38,1	19,0	1,0	30 m
GTB508	GTB508N	GTB508T	GTB508YV	50,8	25,4	1,1	30 m

Guaina termorestringente a parete sottile in rotolo Thin wall heat shrink tubing in roll

Materiale: Poliolefina irradiata
Rapporto di restringimento: 3:1
Temperatura d'esercizio: -55°C +135°C
Temperatura di restringimento: +90°C
Rigidità dielettrica: 20 kV/mm
Resistenza alla trazione: 15 MPa
Resistenza volume specifico: 10¹⁵ w x cm
Assorbimento di acqua: 0,2%
Conformità: CE, RoHS 2015/863/EU
Certificazioni: CSA, UL

Material: Crosslinked polyolefin
Shrink ratio: 3:1
Operating temperature: -55°C +135°C
Shrinking temperature: +90°C
Dielectric strength: 20 kV/mm
Tensile strength: 15 MPa
Specific volume resistance: 10¹⁵ w x cm
Water absorption: 0,2%
Compliance: CE, RoHS 2015/863/EU
Certifications: CSA, UL

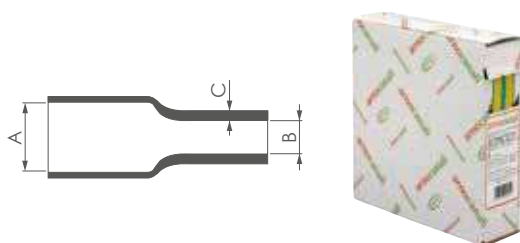

Articolo Item	Restringimento Shrinking			Lunghezza rotolo Roll Length
	Prima Before	Dopo After		
GIALLO/VERDE YELLOW/GREEN	A	B	C	
	A mm	B mm	C mm	
GM032YV	3,2	1,0	0,55	10 m
GM048YV	4,8	1,5	0,60	8 m
GM064YV	6,4	2,0	0,65	6 m
GM095YV	9,5	3,0	0,75	5 m
GM127YV	12,7	4,0	0,75	5 m
GM190YV	19,0	6,0	0,85	4 m
GM254YV	25,4	8,0	1,00	3 m

Guaina medio spessore con adesivo interno, in stecche Medium wall heat shrink tubing with internal adhesive, in bars

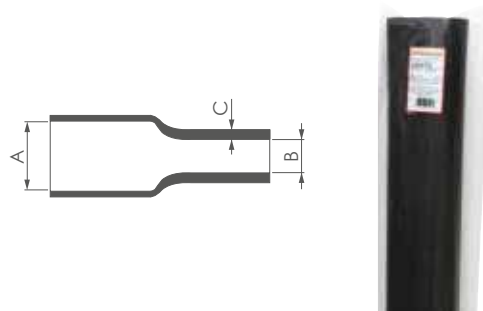

Materiale: Poliolefina irradiata con adesivo interno
Rapporto di restringimento: 4:1
Temperatura d'esercizio: -40°C +120°C
Temperatura di restringimento: +110°C
Rigidità dielettrica: 17 kV/mm
Resistenza alla trazione: 14 MPa
Resistenza volume specifico: 10¹⁵ w x cm
Assorbimento di acqua: 0,12%
Conformità: CE, RoHS 2015/863/EU
Certificazioni: CSA, UL

Material: Crosslinked polyolefin with internal adhesive
Shrink ratio: 4:1
Operating temperature: -40°C +120°C
Shrinking temperature: +110°C
Dielectric strength: 17 kV/mm
Tensile strength: 14 MPa
Specific volume resistance: 10¹⁵ w x cm
Water absorption: 0,12%
Compliance: CE, RoHS 2015/863/EU
Certifications: CSA, UL



Articolo Item	Restringimento Shrinking			Stecche da 1 m per busta Bars 1 m each bag
	Prima Before	Dopo After		
NERO BLACK	A	B	C	
	A mm	B mm	C mm	
GA012	12	3,0	2,20	10 p
GA022	22	6,0	2,30	5 p
GA033	33	7,0	2,60	5 p
GA040	40	12,0	2,60	1 p
GA055	55	17,0	2,90	1 p
GA065	65	19,0	3,15	1 p
GA072	72	22,0	3,15	1 p
GA092	92	35,0	3,35	1 p
GA115	115	35,0	3,35	1 p
GA180	180	60,0	3,50	1 p

Guaina termorestringente a parete sottile in Kit Thin wall heat shrink tubing in Kit

<p>Materiale: Poliolefina irradiata Rapporto di restringimento: 2:1 Temperatura d'esercizio: -40°C +120°C Temperatura di restringimento: +110°C Rigidità dielettrica: 17 kV/mm Resistenza alla trazione: 14 MPa Resistenza volume specifico: 10¹⁵ w x cm Assorbimento di acqua: 0,12% Conformità: CE, RoHS 2015/863/EU</p>		<p>Material: Crosslinked polyolefin Shrink ratio: 2:1 Operating temperature: -40°C +120°C Shrinking temperature: +110°C Dielectric strength: 17 kV/mm Tensile strength: 14 MPa Specific volume resistance: 10¹⁵ w x cm Water absorption: 0,12% Compliance: CE, RoHS 2015/863/EU</p>					
	Articolo Item	Colore Colour	Quantità Quantity	Restringimento Shrinking			Lunghezza spezzone Piece length
				Prima Before	Dopo After		
				A mm	B mm	C mm	
	G-KIT1	Nero Black	30 pz	1,6	0,8	0,4	100 mm
			30 pz	2,4	1,2	0,5	100 mm
			20 pz	4,0	2,0	0,5	100 mm
			10 pz	6,0	3,0	0,6	100 mm
			6 pz	10	5,0	0,6	100 mm
			4 pz	13	6,5	0,6	100 mm
	G-KIT1C	Nero Black	30 pz	1,6	0,8	0,4	100 mm
		Giallo Yellow	30 pz	2,4	1,2	0,5	100 mm
		Rosso Red	20 pz	4,0	2,0	0,5	100 mm
		Verde Green	10 pz	6,0	3,0	0,6	100 mm
		Blu Blue	6 pz	10	5,0	0,6	100 mm
		Bianco White	4 pz	13	6,5	0,6	100 mm

Ugello riflettore piccolo Small reflector nozzle



	Articolo Item
	GUP
	Ugello riflettore piccolo Small reflector nozzle

Ugello riflettore grande Large reflector nozzle



	Articolo Item
	GUG
	Ugello riflettore grande Large reflector nozzle

Termosoffiatore professionale 2 livelli di regolazione Professional heat gun 2 adjustment levels



<p>Potenza: 1.600W Temperatura: 300°C/500°C Volume aria: 240-450 l/min Regolazione temperatura: 2 livelli Dimensione: 252 x 85,5 x 200 mm Lunghezza cavo: 2,2 m Peso: 670 g Conformità: CE, RoHS 2015/863/EU</p>	<p>Power: 1.600W Temperature: 300°C/500°C Air volume: 240-450 l/min Temperature setting: 2 levels Dimensions: 252 x 85,5 x 200 mm Cable length: 2,2 m Weight: 670 g Compliance: CE, RoHS 2015/863/EU</p>
 <p>Art. GHL1620S</p>	

Termosoffiatore professionale 3 livelli di regolazione Professional heat gun 3 adjustment levels



<p>Potenza: 2.000W Temperatura: 80°C/600°C Volume aria: 150-500 l/min Regolazione temperatura: 9 livelli Dimensione: 253 x 84,5 x 200 mm Lunghezza cavo: 2,2 m Peso: 840 g Conformità: CE, RoHS 2015/863/EU</p>	<p>Power: 2.000W Temperature: 80°C/600°C Air volume: 150-500 l/min Temperature setting: 9 levels Dimensions: 253 x 84,5 x 200 mm Cable length: 2,2 m Weight: 840 g Compliance: CE, RoHS 2015/863/EU</p>
 <p>Art. GHL1920E</p>	

WALKABLE

Canali passacavi carrabili e copricavo pedonali

Cable ramps system





Caratteristiche Tecniche

- Materiali utilizzati NR/SBR, TPU, ABS
- Grado di protezione IP30XC
- Tensione isolamento 3kV
- Resistenza di isolamento 51 GΩ
- Carico massimo da 200Kg a 40t su 20x20 cm
- Tensione di esercizio 1000V C.A. - 1500V C.C.
- Campo di durezza da 78 a 95 (Shore A)

Technical Features

- Materials used NR/SBR, TPU, ABS
- Protection degree IP30XC
- Insulation voltage 3kV
- Insulation resistance 51 GΩ
- Maximum load from 200Kg to 40t on 20x20 cm
- Operating voltage 1000V AC - 1500V DC
- Hardness range from 78 to 95 (Shore A)

Riferimenti a Norme

- Conforme alla Norma CEI 64.8 (sez. 704, 708, 752)
- Conforme alla Direttiva RoHS 2015/863/EU
- Conforme alla Direttiva B.T. 2014/35/EU

Norms Reference

- Complies with standard CEI 64.8 (sec. 704, 708, 752)
- Compliant with RoHS Directive 2015/863/EU
- Compliant with the Low Voltage Directive 2014/35/EU

Campi di utilizzo

Cantieri, camping, teatri all'aperto, saloni espositivi, mercati, sagre, zone militari, aree pubbliche, concerti, ospedali da campo, ecc.

Fields of use

Construction, camping, open-air theaters, exhibition halls, markets, festivals, military areas, public areas, concerts, field hospitals, etc.

Marchi e Certificazioni

- Marcatura CE

Marks and Certifications

- CE marking

Colori disponibili

- Nero, Nero/Giallo

Available colours

- Black, Black/Yellow

Canale passacavi carrabile in gomma Drive-over cable ramp in rubber

Materiale: NR/SBR (Gomma naturale)

Colore: Nero e giallo

Peso: 7,8 Kg(ZPC2), 13 Kg(ZPC3), 14 Kg(ZPC5)

Capacità di carico: 3 t (ZPC2), 5 t (ZPC3,ZPC5)

Temperatura di esercizio: -20°C +70°C

Campo di durezza: 78 ± 5

Classe di infiammabilità: ND

Material: NR/SBR (Natural rubber)

Colour: Black and yellow

Weight: 7,8 Kg(ZPC2), 13 Kg(ZPC3), 14 Kg (ZPC5)

Load capacity: 3 t (ZPC2), 5 t (ZPC3,ZPC5)

Working temperature: -20°C +70°C

Hardness field: 78 ± 5

Flammability class: ND

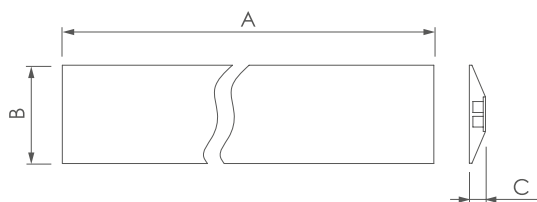

Articolo Item	Descrizione Description	A mm	B mm	C mm
ZPC2	2 scomparti 2 channels	1000	245	45
ZPC3	3 scomparti 3 channels	900	350	50
ZPC5	5 scomparti 5 channels	800	450	50

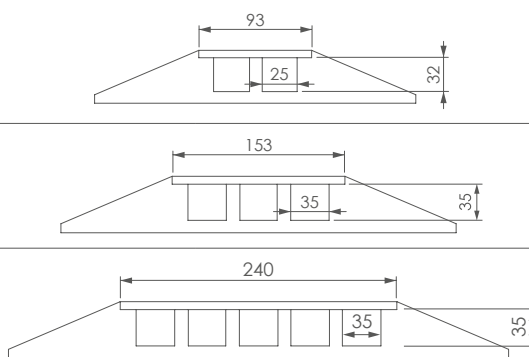

Curva a 30° 30° curve

Articolo Item	Descrizione Description	L mm	H mm
ZPW2	2 scomparti 2 channels	245	45
ZPW3	3 scomparti 3 channels	350	50
ZPW5	5 scomparti 5 channels	450	50



Coppia di terminali End piece kit

Articolo Item	Descrizione Description	L mm	H mm
ZPE2	2 scomparti 2 channels	245	45
ZPE3	3 scomparti 3 channels	350	50
ZPE5	5 scomparti 5 channels	450	50



Canale passacavi carrabile in poliuretano Drive-over cable ramp in polyurethane

Materiale: TPU (Poliuretano termoplastico)
Colore: Nero e giallo
Peso: 4 Kg (ZTC2), 11 Kg (ZTC3), 8 Kg (ZTC5)
Capacità di carico: 24 t (ZTC2), 28 t (ZTC3), 40 t (ZTC5)
Temperatura di esercizio: -25°C +60°C
Campo di durezza: 92A
Classe di infiammabilità: B2

Material: TPU (Thermoplastic polyuretane)
Colour: Black and yellow
Weight: 4 Kg (ZTC2), 11 Kg (ZTC3), 8 Kg (ZTC5)
Load capacity: 24 t (ZTC2), 28 t (ZTC3), 40 t (ZTC5)
Working temperature: -25°C +60°C
Hardness field: 92A
Flammability class: B2

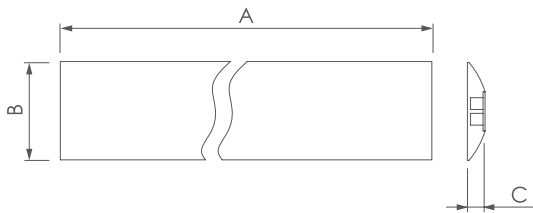

Articolo Item	Descrizione Description	A mm	B mm	C mm
ZTC2	2 scomparti 2 channels	935	255	55
ZTC3	3 scomparti 3 channels	900	500	75
ZTC5	5 scomparti 5 channels	945	500	45

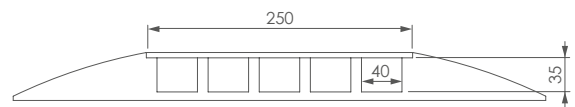
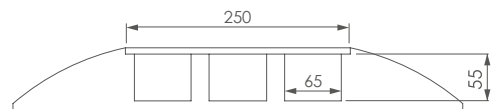
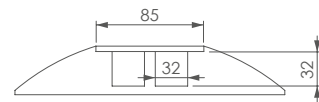

Curva a 45° 45° curve

Articolo Item	Descrizione Description	L mm	H mm
ZTW2	2 scomparti 2 channels	255	55
ZTW3	3 scomparti 3 channels	500	75
ZTW5	5 scomparti 5 channels	500	55



Coppia di terminali End piece kit

Articolo Item	Descrizione Description	L mm	H mm
ZTE2	2 scomparti 2 channels	255	55
ZTE3	3 scomparti 3 channels	500	75
ZTE5	5 scomparti 5 channels	500	55



Coperchio di ricambio per canali passacavi Replacement cover for cable ramps

I coperchi dei canali carrabili sono cernierati su un lato. Col transitare dei veicoli si possono rompere e quindi offriamo i coperchi come pezzo di ricambio

The covers of the cable ramps are hinged on one side. They can break as vehicles pass by and therefore we offer the covers as replacement parts

Articolo Item	Descrizione Description
ZPR2	Per canale ZPC2 For cable ramp ZPC2
ZPR3	Per canale ZPC3 For cable ramp ZPC3
ZPR5	Per canale ZPC5 For cable ramp ZPC5

ZTR2	Per canale ZTC2 For cable ramp ZTC2
ZTR3	Per canale ZTC3 For cable ramp ZTC3
ZTR5	Per canale ZTC5 For cable ramp ZTC5



Canale copricavo Cable cover

Materiale: TPU (Poliuretano termoplastico) Colore: Nero Peso: 1,3 Kg(ZCU1), 3,8 Kg(ZCU2) Capacità di carico: 200 Kg(ZCU1), 5 Tons(ZCU2) Temperatura di esercizio: -25°C +60°C Campo di durezza: 92A Classe di infiammabilità: B2					Material: TPU (Thermoplastic polyuretane) Colour: Black Weight: 1,3 Kg(ZCU1), 3,8 Kg(ZCU2) Load capacity: 200 Kg(ZCU1), 5 Tons(ZCU2) Working temperature: -25°C +60°C Hardness field: 92A Flammability class: B2
Articolo Item	Descrizione Description	A mm	B mm	C mm	
ZCU1	1 scomparto 1 channel	900	140	20	
ZCU2	2 scomparti 2 channels	900	275	40	

Canale copricavo snodato Articuled cable cover

Materiale: ABS rigido (acrilonitrile butadiene stirene) Colore: Nero e giallo Peso: 0,8 Kg(ZCV1), 1,5 Kg(ZCV2) Capacità di carico: 200 Kg(ZCV1), 1 Tons(ZCV2) Temperatura di esercizio: -25°C +60°C Campo di durezza: 95A Classe di infiammabilità: B2					Material: Rigid ABS (acrylonitrile butadiene styrene) Colour: Black and yellow Weight: 0,8 Kg(ZCV1), 1,5 Kg(ZCV2) Load capacity: 200 Kg(ZCV1), 1 Tons(ZCV2) Working temperature: -25°C +60°C Hardness field: 95A Flammability class: B2
Articolo Item	Descrizione Description	A mm	B mm	C mm	
ZCV1	1 scomparto 1 channel	1000	80	15	
ZCV2	1 scomparto 1 channel	1000	150	25	



Boxline

226

Morsetti unipolari, a cappuccio, serraggio indiretto e multiforo
Unipolar, multi holes, indirect tightening connectors and terminal blocks

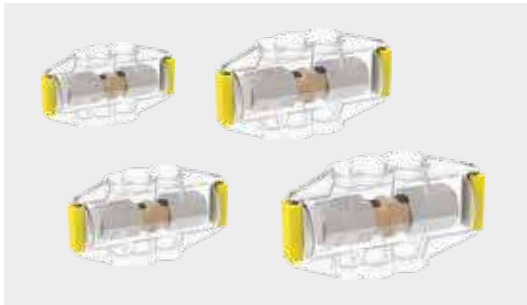

Boxkanal

230

Morsetti a serraggio indiretto per canale
Indirect tightening shunt terminals

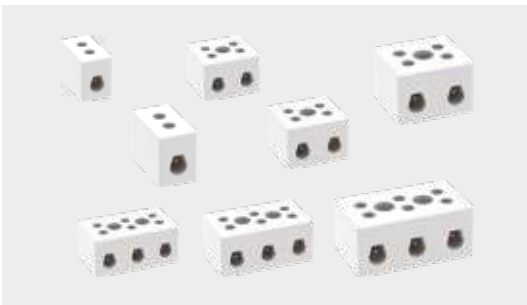

Hot

231

Morsettiere in ceramica
Ceramic terminal blocks

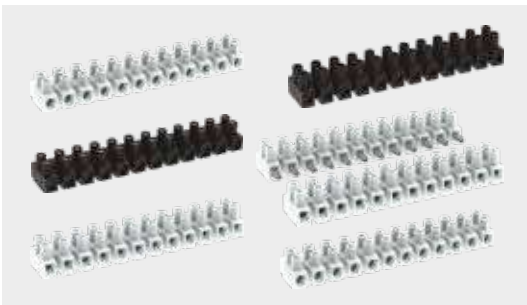

Boxterminal

232

Morsettiere
in Poliammide e Polipropilene
Terminal strips
in Polyamide and Polypropylene



Hybrid-Minibox

238

Morsetti a cablaggio rapido
per cavi rigidi e flessibili
Fast connectors
for solid and flexible wires

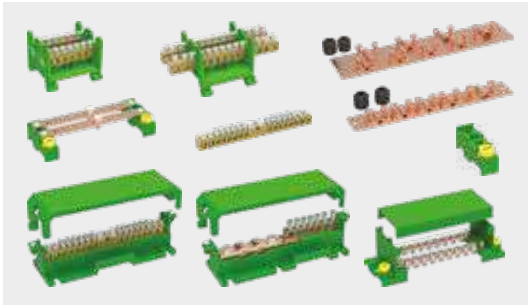

Equijoint

240

Morsettiere equipotenziali
Equipotential earthing terminals

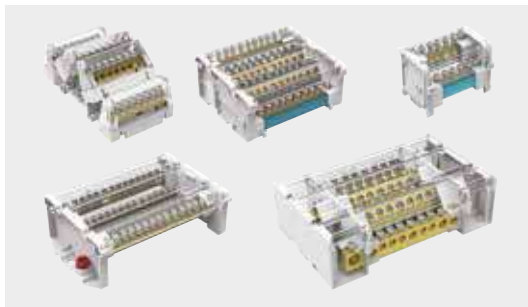

Boxdin

246

Morsettiere di ripartizione con coperchio
Distribution terminals with cover

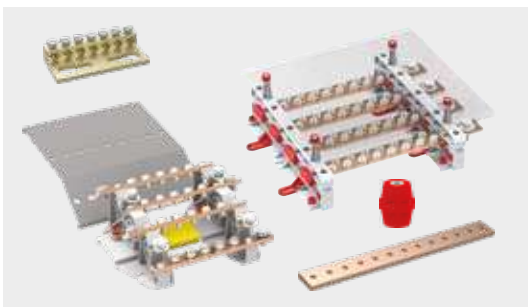

Boxbarra

250

Ripartitori quadripolari e accessori
Quadripolar distribution frames
and accessories



Boxdis

260

Morsetti di ripartizione
Distribution terminal blocks



Quadrix

262

Morsetti da quadro
Terminal blocks

BOXLINE morsetti unipolari a cappuccio BOXLINE unipolar terminal blocks

<p>Certificazioni: IMQ, SEMKO Conformità: CE, RoHS 2015/863/EU Normative: EN 60998-1:2004 Materiale guscio: Polycarbonato Materiale inserto: Ottone Materiale viti: acciaio zincato Temperatura d'esercizio: -5°C +85°C Resistenza al calore: 130°C</p>	<p>Approvals: IMQ, SEMKO Compliance: CE, RoHS 2015/863/EU Standards: EN 60998-1: 2004 Shell material: Polycarbonate Insert material: Brass Screws material: zinc plated steel Working temperature: -5°C +85°C Heat resistance: 130°C</p>	 
--	---	---

Articolo Item	Sezione nominale Nominal section	Tensione Nominale Rated voltage	Grado di protezione Protection degree	Corrente nominale Rated current	Poli per stecca Bar poles	Conduttori connettibili Connectable cables	Dimensioni Dimensions			
							A mm	B mm	C mm	Ø D mm
B15	1,5 mm ²	450 V	IP20	17,5 A	10	2x1,5 mm ² 3x1,0 mm ² 4x0,75 mm ²	16,5	90	15,5	3,2
B25	2,5 mm ²	450 V	IP20	24 A	10	2x2,5 mm ² 3x1,5 mm ² 4x1,0 mm ²	20	110	18,5	4
B40	4 mm ²	450 V	IP20	32 A	10	2x4,0 mm ² 3x2,5 mm ² 4x1,5 mm ²	22,2	116	19,7	4,5
B60	6 mm ²	450 V	IP20	41 A	10	2x6,0 mm ² 3x4,0 mm ² 4x2,5 mm ²	24,5	137	22	6
B100	10 mm ²	500 V	IP20	57 A	10	2x10 mm ² 3x6,0 mm ² 4x4,0 mm ²	29	157	25	7,5
B160	16 mm ²	500 V	IP00	76 A	5	2x16 mm ² 3x10 mm ² 4x6,0 mm ²	34,7	100	31	9,5
B250	25 mm ²	500 V	IP00	101 A	1	2x25 mm ² 3x16 mm ² 4x10 mm ²	38,5	22	40	12
B350	35 mm ²	500 V	IP00	125 A	1	2x35 mm ² 3x25 mm ² 4x16 mm ²	45,5	24,5	42,8	14

Versione ad 1 polo 1 pole version

B15.1	1,5 mm ²	450 V	IP20	17,5 A	1	2x1,5 mm ² 3x1,0 mm ² 4x0,75 mm ²	16,5	7,8	15,5	3,2
B25.1	2,5 mm ²	450 V	IP20	24 A	1	2x2,5 mm ² 3x1,5 mm ² 4x1,0 mm ²	20	9,7	18,5	4
B40.1	4 mm ²	450 V	IP20	32 A	1	2x4,0 mm ² 3x2,5 mm ² 4x1,5 mm ²	22,2	10,4	19,7	4,5
B60.1	6 mm ²	450 V	IP20	41 A	1	2x6,0 mm ² 3x4,0 mm ² 4x2,5 mm ²	24,5	12,5	22	6
B100.1	10 mm ²	500 V	IP20	57 A	1	2x10 mm ² 3x6,0 mm ² 4x4,0 mm ²	29	14,6	25	7,5

BOXLINE Z morsetti a cappuccio a serraggio indiretto BOXLINE Z indirect tightening terminal blocks

<p>Certificazioni: IMQ, RINA Conformità: CE, RoHS 2015/863/EU Normative: EN 60998-1:2004 Materiale guscio: Policarbonato e poliammide Materiale inserto: acciaio zincato Materiale viti: acciaio zincato Temperatura d'esercizio: -5°C +85°C Resistenza al calore: 130°C</p>	<p>Approvals: IMQ, RINA Compliance: CE, RoHS 2015/863/EU Standards: EN 60998-1: 2004 Shell material: Polycarbonate and Polyamide Insert material: zinc plated steel Screws material: zinc plated steel Working temperature: -5°C +85°C Heat resistance: 130°C</p>	 
---	--	---

Articolo Item	Sezione nominale Nominal section	Tensione Nominale Rated voltage	Grado di protezione Protection degree	Corrente nominale Rated current	Poli per stecca Bar poles	Conduttori connettibili Connectable cables	Dimensioni Dimensions				
							A mm	B mm	C mm	D mm	E mm
BZ25	2,5 mm ²	750 V	IP20	24 A	8	2x2,5 mm ² 3x1,5 mm ² 5x1,0 mm ²	79,5	20	19	10,5	8,5
BZ40	4 mm ²	750 V	IP20	32 A	8	2x4,0 mm ² 3x2,5 mm ² 5x1,5 mm ²	94,5	24,5	22,5	12,5	10,5
BZ60	6 mm ²	750 V	IP20	41 A	8	2x6,0 mm ² 3x4,0 mm ² 4x2,5 mm ²	110	29	32	16	12
BZ100	10 mm ²	750 V	IP20	57 A	8	2x10 mm ² 3x6 mm ² 5x4 mm ²	132	32	32	18	15
BZ160	16 mm ²	750 V	IP00	76 A	4	2x16 mm ² 3x10 mm ² 5x6 mm ²	77,5	39	34,5	21	18
BZ250	25 mm ²	750 V	IP00	101 A	2	2x25 mm ² 3x16 mm ² 5x10 mm ²	41,5	41	42,5	22	19
BZ350	35 mm ²	750 V	IP00	125 A	2	2x35 mm ² 2x25 mm ² 4x16 mm ²	52	49	45,5	26	24,5



Nel morsetto BOXLINE la vite tocca direttamente il rame dei cavi
 In the BOXLINE terminal, the screw directly touches the copper of the cables

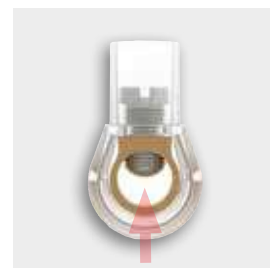

Nel morsetto BOXLINE Z la vite spinge una lamella in acciaio che serra i cavi, quindi non ha un contatto diretto sul rame dei cavi
 In the BOXLINE Z terminal, the screw pushes a steel blade that tightens the cables, so it does not have direct contact on the copper of the cables



BOXLINE 2 morsetti unipolari a 2 fori BOXLINE 2 unipolar terminal blocks 2 holes

<p>Certificazioni: IMQ Conformità: CE, RoHS 2015/863/EU Normative: EN 60998-1:2004 Materiale guscio: Policarbonato Materiale inserto: Ottone Materiale viti: acciaio zincato Temperatura d'esercizio: -5°C +85°C Resistenza al calore: 130°C</p>	<p>Approvals: IMQ Compliance: CE, RoHS 2015/863/EU Standards: EN 60998-1: 2004 Shell material: Polycarbonate Insert material: Ottone Screws material: zinc plated steel Working temperature: -5°C +85°C Heat resistance: 130°C</p>	 
---	---	--

Articolo Item	Sezione nominale Nominal section	N. fori N. holes	Tensione Nominale Rated voltage	Grado di protezione Protection degree	Corrente nominale Rated current	Conduttori connettibili Connectable cables	Dimensioni Dimensions			
							A mm	B mm	C mm	Ø D mm
B22	4 mm ²	2	450 V	IP20	32 A	2x4 mm ² 2x2,5 mm ² 4x1,5 mm ²	16	12	15	3,2
B42	6 mm ²	2	450 V	IP20	41 A	2x6 mm ² 2x4 mm ² 4x2,5 mm ²	20	16	19	4
B62	16 mm ²	2	500 V	IP00	76 A	2x16 mm ² 2x10 mm ² 4x6 mm ²	25	21	25	6
B252	25 mm ²	2	500 V	IP00	101 A	2x25 mm ² 2x16 mm ² 4x10 mm ²	29	26	29	7,5
B352	35 mm ²	2	500 V	IP00	125 A	2x35 mm ² 2x25 mm ² 4x16 mm ²	33	32	31	9
B502	50 mm ²	2	500 V	IP00	151 A	2x50 mm ² 2x35 mm ² 4x25 mm ²	45	38	40	12

BOXLINE 2 morsetti unipolari a 2 fori BOXLINE 2 unipolar terminal blocks 2 holes

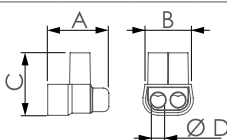
<p>Certificazioni: IMQ Conformità: CE, RoHS 2015/863/EU Normative: EN 60998-1:2004 Materiale guscio: Policarbonato Materiale inserto: Ottone Materiale viti: acciaio zincato Temperatura d'esercizio: -5°C +85°C Resistenza al calore: 130°C Aggancio guida DIN: con supporto 159SM</p>	<p>Approvals: IMQ Compliance: CE, RoHS 2015/863/EU Standards: EN 60998-1: 2004 Shell material: Polycarbonate Insert material: Ottone Screws material: zinc plated steel Working temperature: -5°C +85°C Heat resistance: 130°C Fixing on din rail: with support 159SM</p>	 
---	---	--

Articolo Item	Sezione nominale Nominal section	N. fori N. holes	Tensione Nominale Rated voltage	Grado di protezione Protection degree	Corrente nominale Rated current	Conduttori connettibili Connectable cables	Dimensioni Dimensions			
							A mm	B mm	C mm	Ø D mm
B102	25 mm ²	2	500 V	IP00	101 A	2x25 mm ² 2x16 mm ² 4x10 mm ²	29	26	29	7,5
B162	35 mm ²	2	500 V	IP00	125 A	2x35 mm ² 2x25 mm ² 4x16 mm ²	33	32	31	9

BOXLINE 3 morsetti unipolari a 3 fori BOXLINE 3 unipolar terminal blocks 3 holes

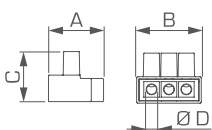
<p>Certificazioni: IMQ Conformità: CE, RoHS 2015/863/EU Normative: EN 60998-1:2004 Materiale guscio: Policarbonato e poliammide Materiale inserto: Ottone Materiale viti: acciaio zincato Temperatura d'esercizio: -5°C +85°C Resistenza al calore: 130°C Aggancio guida DIN: con supporto 159SM</p>	<p>Approvals: IMQ Compliance: CE, RoHS 2015/863/EU Standards: EN 60998-1: 2004 Shell material: Polycarbonate and Polyamide Insert material: Ottone Screws material: zinc plated steel Working temperature: -5°C +85°C Heat resistance: 130°C Fixing on din rail: with support 159SM</p>	 
---	--	--

Articolo Item	Sezione nominale Nominal section	N. fori N. holes	Tensione Nominale Rated voltage	Grado di protezione Protection degree	Corrente nominale Rated current	Conduttori connettibili Connectable cables	Dimensioni Dimensions			
							A mm	B mm	C mm	Ø D mm
B63	6 mm ²	3	450 V	IP20	41 A	3x6 mm ² 3x4 mm ² 6x2,5 mm ²	25	30	23	4,5
B163	16 mm ²	3	500 V	IP20	76 A	3x16 mm ² 3x10 mm ² 6x6 mm ²	28	34	26	6
B253	25 mm ²	3	500 V	IP20	101 A	3x25 mm ² 3x16 mm ² 6x10 mm ²	33	40	30	9,5

BOXLINE 5 morsetti unipolari a 5 fori BOXLINE 5 unipolar terminal blocks 5 holes

<p>Certificazioni: IMQ Conformità: CE, RoHS 2015/863/EU Normative: EN 60998-1:2004 Materiale guscio: Policarbonato e poliammide Materiale inserto: Ottone Materiale viti: acciaio zincato Temperatura d'esercizio: -5°C +85°C Resistenza al calore: 130°C Aggancio guida DIN: con supporto 159SM</p>	<p>Approvals: IMQ Compliance: CE, RoHS 2015/863/EU Standards: EN 60998-1: 2004 Shell material: Polycarbonate and Polyamide Insert material: Ottone Screws material: zinc plated steel Working temperature: -5°C +85°C Heat resistance: 130°C Fixing on din rail: with support 159SM</p>	 
---	--	--

Articolo Item	Sezione nominale Nominal section	N. fori N. holes	Tensione Nom- nale Rated voltage	Grado di protezione Protection degree	Corrente nominale Rated current	Conduttori connettibili Connectable cables	Dimensioni Dimensions			
							A mm	B mm	C mm	Ø D mm
B65	6 mm ²	5	450 V	IP20	41 A	5x6 mm ² 5x4 mm ² 10x2,5 mm ²	25	45	23	4,5
B165	16 mm ²	5	500 V	IP20	76 A	5x16 mm ² 5x10 mm ² 10x6 mm ²	28	52	26	6
B255	25 mm ²	5	500 V	IP20	101 A	5x25 mm ² 5x16 mm ² 10x10 mm ²	33	62	30	7,5



I morsetti a 2 fori B102 e B162, a 3 fori e 5 fori hanno una predisposizione per il fissaggio su guida DIN con il supporto articolo **159SM**

The terminals with 2 holes B102 and B162, 3 holes and 5 holes have a prearrangement for fixing on DIN rail using the support item **159SM**



BOXLINE 7, 11, 15 morsetti unipolari multiforo BOXLINE 7, 11, 15 unipolar terminal blocks multi-holes

<p>Certificazioni: IMQ Conformità: CE, RoHS 2015/863/EU Normative: EN 60998-1:2004 Materiale guscio: Policarbonato e poliammide Materiale inserto: Ottone Materiale viti: acciaio zincato Temperatura d'esercizio: -5°C +85°C Resistenza al calore: 130°C</p>	<p>Approvals: IMQ Compliance: CE, RoHS 2015/863/EU Standards: EN 60998-1: 2004 Shell material: Polycarbonate and Polyamide Insert material: Ottone Screws material: zinc plated steel Working temperature: -5°C +85°C Heat resistance: 130°C</p>	
---	--	--

Articolo Item	Colore Color	N. fori N. holes	Dimensioni fori Holes dimension	Tensione Nominale Rated voltage	Grado di protezione Protection degree	Conduttori connettibili Connectable cables	Dimensioni Dimensions				
							A mm	B mm	C mm	ØD1 mm	ØD2 mm
507F	Grigio Grey	7	2xØ6 mm 5xØ5,3 mm	750 V	IP00	2x16 mm ² 5x10 mm ²	19	59	34	6	5,3
507N	Blu Blue										
T167	Verde Green										
5011F	Grigio Grey	11	2xØ6 mm 9xØ5,3 mm	750 V	IP00	2x16 mm ² 9x10 mm ²	19	88	34	6	5,3
5011N	Blu Blue										
T1611	Verde Green										
5015F	Grigio Grey	15	2xØ6 mm 13xØ5,3 mm	750 V	IP00	2x16 mm ² 13x10 mm ²	19	114	34	6	5,3
5015N	Blu Blue										
T1615	Verde Green										

BOXKANAL morsetti di derivazione senza interruzione del cavo BOXKANAL derivation shunt terminals

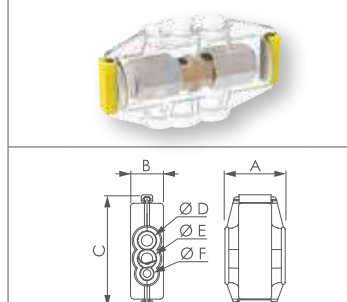
<p>Certificazioni: IMQ Conformità: CE, RoHS 2015/863/EU Normative: EN 60998-1:2004 Materiale guscio: Policarbonato Materiale inserto: Ottone Temperatura d'esercizio: -5°C +85°C Resistenza al calore: 130°C</p>	<p>Approvals: IMQ Compliance: CE, RoHS 2015/863/EU Standards: EN 60998-1: 2004 Material: Polycarbonate Insert material: Ottone Working temperature: -5°C +85°C Heat resistance: 130°C</p>	
---	--	---

Articolo Item	Tensione Nominale Rated voltage	Corrente nominale Rated current	Grado di protezione Protection degree	Conduttore primario Main cable	Conduttori derivabili Derivable cables	Dimensioni Dimensions					
						A mm	B mm	C mm	Ø D mm	Ø E mm	Ø F mm
BK616	500 V	76 A	IP20	16 mm ²	1x16 mm ² - 1x10 mm ² 2x6 mm ² - 4x4 mm ²	45,5	25,5	67	13	13	7
BK635	500 V	125 A	IP20	35 mm ²	1x35 mm ² - 1x25 mm ² 2x16 mm ² - 3x10 mm ²	46,5	26	84	15	15	11
BK650	500 V	160 A	IP20	50 mm ²	1x50 mm ² - 1x35 mm ² 2x25 mm ² - 3x16 mm ²	50	29	95	18	18	13
BK670	500 V	192 A	IP20	70 mm ²	1x70 mm ² - 1x50 mm ² 2x35 mm ² - 3x25 mm ²	52	31,5	106	19	19	14







HOT morsetti in steatite HOT steatite terminal blocks

<p>Conformità: CE, RoHS 2015/863/EU Normative: EN 60998-1:2004 Materiale guscio: Steatite Materiale inserto: Ottone Nichelato Materiale vite: Acciaio Zincato Temperatura d'esercizio: -40°C +300°C Resistenza al calore: 650°C</p>	<p>Compliance: CE, RoHS 2015/863/EU Standards: EN 60998-1: 2004 Shell material: Steatite Insert material: Nickel Plated Brass Screw material: Zinc Plated Steel Working temperature: -40°C +300°C Heat resistance: 650°C</p>	 
--	---	--

Articolo Item		BH60.1	BH60.2	BH60.3	BH100.1	BH100.2	BH100.3	BH160.2	BH160.3
Sezione nominale Nominal section		4 mm ²	4 mm ²	4 mm ²	6 mm ²	6 mm ²	6 mm ²	10 mm ²	10 mm ²
Tensione Nominale Rated voltage		450 V	450 V	450 V	450 V	450 V	450 V	450 V	450 V
Grado di protezione Protection degree		IP20	IP20	IP20	IP20	IP20	IP00	IP00	IP00
Corrente nominale Rated current		32 A	32 A	32 A	41 A	41 A	41 A	57 A	57 A
N. fori di fissaggio N. of fixing holes		-	1	2	-	1	2	1	2
Interasse di fissaggio Fixing center distance		-	-	13 mm	-	-	13 mm	-	17 mm
Conduttori connettibili Connectable cables	Flessibili Flexible	2x4 mm ²	2x4 mm ²	2x4 mm ²	2x6 mm ²	2x6 mm ²	2x6 mm ²	2x10 mm ²	2x10 mm ²
	Rigidi Rigid	2x6 mm ²	2x6 mm ²	2x6 mm ²	2x10 mm ²	2x10 mm ²	2x10 mm ²	2x16 mm ²	2x16 mm ²
Dimensioni Dimensions	A mm	12	21	33	13	24	36	31	48
	B mm	16	18	18	21	21	21	26	26
	C mm	16	16	16	20	20	20	20	20
	Ø D mm	-	4,5	4,5	-	4,8	4,8	5	5
	Ø E mm	3,2	3,2	3,2	4,3	4,3	4,3	6,1	6,1
	F mm	-	12	12	-	16	16	12	12
Ø G mm	-	7	7	-	7,2	7,2	7,6	7,6	

BOXTERMINAL morsettiere in poliammide
BOXTERMINAL polyamide terminal strips

<p>Conformità: CE, RoHS 2015/863/EU Normative: EN 60998-1:2004 Materiale guscio: Poliammide Materiale inserto: Ottone Nichelato Materiale vite: Acciaio Zincato Temperatura d'esercizio: -30°C +110°C Resistenza al calore: 150°C</p>	<p>Compliance: CE, RoHS 2015/863/EU Standards: EN 60998-1: 2004 Shell material: Polyamide Insert material: Nickel Plated Brass Screw material: Zinc Plated Steel Working temperature: -30°C +110°C Heat resistance: 150°C</p>	
		

Articolo Item		B204	B206	B210	B216	B225	B235
Sezione nominale Nominal section		1,5 mm ²	2,5 mm ²	6 mm ²	10 mm ²	16 mm ²	25 mm ²
Tensione Nominale Rated voltage		450 V	450 V	500 V	500 V	500 V	750 V
Grado di protezione Protection degree		IP20	IP20	IP20	IP20	IP20	IP20
Corrente nominale Rated current		17,5 A	24 A	41 A	57 A	76 A	101 A
Poli per stecca Bar poles		12	12	12	12	12	12
Conduttori connettibili Connectable cables		2x2,5 mm ²	2x4 mm ²	2x6 mm ²	2x10 mm ²	2x16 mm ²	2x25 mm ²
Dimensioni Dimensions	A mm	96,2	117,2	140,7	158	170	208,5
	B mm	17	20,2	23,8	25,6	28,1	37,5
	C mm	14,5	16,8	19	25	23	34
	D mm	8,2	10	12	13,5	14,5	18
	Ø E mm	2,9	3,6	3,9	4,4	4,2	4,5
	Ø F mm	2,8	3,4	4,2	5	6	7,4
Certificazioni Approvals							



I morsetti della linea Boxterminal possono essere montati su guida DIN utilizzando il supporto art. **159SM**

The terminals of the Boxterminal line can be mounted on a DIN rail using the support item **159SM**

BOXTERMINAL morsettiere in poliammide BOXTERMINAL polyamide terminal strips

<p>Conformità: CE, RoHS 2015/863/EU Normative: EN 60998-1:2004 Materiale guscio: Poliammide Materiale inserto: Acciaio Zincato Materiale vite: Acciaio Zincato Temperatura d'esercizio: -30°C +110°C Resistenza al calore: 150°C</p>	<p>Compliance: CE, RoHS 2015/863/EU Standards: EN 60998-1: 2004 Shell material: Polyamide Insert material: Zinc Plated Steel Screw material: Zinc Plated Steel Working temperature: -30°C +110°C Heat resistance: 150°C</p>	 
---	--	--

Articolo Item		BA204	BA206	BA210
Sezione nominale Nominal section		2,5 mm ²	4 mm ²	10 mm ²
Tensione Nominale Rated voltage		450 V	450 V	500 V
Grado di protezione Protection degree		IP20	IP20	IP20
Corrente nominale Rated current		24 A	32 A	57 A
Poli per stecca Bar poles		12	12	12
Conduttori connettibili Connectable cables		2x4 mm ²	2x6 mm ²	2x10 mm ²
Dimensioni Dimensions	A mm	96,2	116,8	141
	B mm	17	19,2	23,5
	C mm	14,5	16,7	18,7
	D mm	8,2	10	12
	Ø E mm	2,9	3,6	3,9
	Ø F mm	3,2	3,4	4,5
Certificazioni Approvals				







I morsetti della linea Boxterminal possono essere montati su guida DIN utilizzando il supporto art. **159SM**

The terminals of the Boxterminal line can be mounted on a DIN rail using the support item **159SM**

BOXTERMINAL morsettiere con lamella proteggicavo in poliammide
BOXTERMINAL polyamide terminal strips with wire protection

<p>Conformità: CE, RoHS 2015/863/EU Normative: EN 60998-1:2004 Materiale guscio: Poliammide Materiale inserto: Ottone Nichelato Materiale vite: Acciaio Zincato Temperatura d'esercizio: -30°C +110°C Resistenza al calore: 150°C</p>	<p>Compliance: CE, RoHS 2015/863/EU Standards: EN 60998-1: 2004 Shell material: Polyamide Insert material: Nickel Plated Brass Screw material: Zinc Plated Steel Working temperature: -30°C +110°C Heat resistance: 150°C</p>	 
--	--	--

Articolo Item	BL204	BL206	BL210	BL216	
Sezione nominale Nominal section	1,5 mm ²	2,5 mm ²	6 mm ²	10 mm ²	
Tensione Nominale Rated voltage	450 V	450 V	500 V	500 V	
Grado di protezione Protection degree	IP20	IP20	IP20	IP20	
Corrente nominale Rated current	17,5 A	24 A	41 A	57 A	
Poli per stecca Bar poles	12	12	12	12	
Conduttori conneffibili Connectable cables	2x1,5 mm ²	2x2,5 mm ²	2x6 mm ²	2x10 mm ²	
Dimensioni Dimensions	A mm	92,2	117,2	140,7	158
	B mm	17	20,2	23,8	25,6
	C mm	14,5	16,8	19	25
	D mm	8,2	10	12	13,5
	Ø E mm	2,9	3,6	3,9	4,4
	Ø F mm	2,8	3,4	4,2	5
Certificazioni Approvals					





I morsetti della linea Boxterminal possono essere montati su guida DIN utilizzando il supporto art. **159SM**

The terminals of the Boxterminal line can be mounted on a DIN rail using the support item **159SM**

BOXTERMINAL morsettiere a spina in poliammide BOXTERMINAL polyamide plug-in terminals

<p>Conformità: CE, RoHS 2015/863/EU Normative: EN 60998-1:2004 Materiale guscio: Poliammide Materiale inserto: Ottone Nichelato Materiale vite: Acciaio Zincato Temperatura d'esercizio: -30°C +110°C Resistenza al calore: 150°C</p>	<p>Compliance: CE, RoHS 2015/863/EU Standards: EN 60998-1: 2004 Shell material: Polyamide Insert material: Nickel Plated Brass Screw material: Zinc Plated Steel Working temperature: -30°C +110°C Heat resistance: 150°C</p>	 
--	--	--

Articolo Item		B204S	B206S	B210S
Sezione nominale Nominal section		2,5 mm ²	4 mm ²	10 mm ²
Tensione Nominale Rated voltage		250 V	250 V	250 V
Grado di protezione Protection degree		IP20	IP20	IP20
Corrente nominale Rated current		24 A	32 A	57 A
Poli per stecca Bar poles		12	12	12
Conduttori connettabili Connectable cables		2x2,5 mm ²	2x4 mm ²	2x10 mm ²
Dimensioni Dimensions	A mm	95	117	140
	B mm	16,3	20,2	23,2
	C mm	15	16,6	20,3
	D mm	6	10	10
	Ø E mm	2,9	3,4	4,3
	Ø F mm	2,8	3,4	4,1
Certificazioni Approvals				







I morsetti della linea Boxterminal possono essere montati su guida DIN utilizzando il supporto art. **159SM**

The terminals of the Boxterminal line can be mounted on a DIN rail using the support item **159SM**

BOXTERMINAL morsettiere in polipropilene
BOXTERMINAL polypropylene terminal strips

<p>Conformità: CE, RoHS 2015/863/EU Normative: EN 60998-1:2004 Materiale guscio: Polipropilene BIANCO Materiale inserto: Acciaio Zincato Materiale vite: Acciaio Zincato Temperatura d'esercizio: -5°C +85°C Resistenza al calore: 130°C</p>	<p>Compliance: CE, RoHS 2015/863/EU Standards: EN 60998-1: 2004 Shell material: WHITE Polypropylene Insert material: Zinc Plated Steel Screw material: Zinc Plated Steel Working temperature: -5°C +85°C Heat resistance: 130°C</p>	
		

Articolo Item	B104	B106	B110	B116	B125	
Sezione nominale Nominal section	2,5 mm ²	4 mm ²	10 mm ²	16 mm ²	25 mm ²	
Tensione Nominale Rated voltage	450 V	450 V	500 V	500 V	750 V	
Grado di protezione Protection degree	IP20	IP20	IP20	IP20	IP20	
Corrente nominale Rated current	24 A	32 A	57 A	76 A	101 A	
Poli per stecca Bar poles	12	12	12	12	12	
Conduttori connettabili Connectable cables	2x4 mm ²	2x6 mm ²	2x10 mm ²	2x16 mm ²	2x25 mm ²	
Dimensioni Dimensions	A mm	96,2	116,8	140,5	169,8	195
	B mm	17	19,2	23,5	25	36
	C mm	14,5	16,7	18,7	20,8	26,1
	D mm	8,2	10	12	14,5	16,5
	Ø E mm	2,9	3,6	3,9	4,3	4,3
	Ø F mm	3,2	3,4	4,5	6,5	7
Certificazioni Certifications						



I morsetti della linea Boxterminal possono essere montati su guida DIN utilizzando il supporto art. **159SM**

The terminals of the Boxterminal line can be mounted on a DIN rail using the support item **159SM**

BOXTERMINAL morsettiere in polipropilene BOXTERMINAL polypropylene terminal strips

<p>Conformità: CE, RoHS 2015/863/EU Normative: EN 60998-1:2004 Materiale guscio: Polipropilene NERO Materiale inserto: Acciaio Zincato Materiale vite: Acciaio Zincato Temperatura d'esercizio: -5°C +85°C Resistenza al calore: 130°C</p>	<p>Compliance: CE, RoHS 2015/863/EU Standards: EN 60998-1: 2004 Shell material: BLACK Polypropylene Insert material: Zinc Plated Steel Screw material: Zinc Plated Steel Working temperature: -5°C +85°C Heat resistance: 130°C</p>	 
---	--	--

Articolo Item	B2104	B2106	B2110	B2116	B2125	
Sezione nominale Nominal section	2,5 mm ²	4 mm ²	10 mm ²	16 mm ²	25 mm ²	
Tensione Nominale Rated voltage	450 V	450 V	500 V	500 V	750 V	
Grado di protezione Protection degree	IP20	IP20	IP20	IP20	IP20	
Corrente nominale Rated current	24 A	32 A	57 A	76 A	101 A	
Poli per stecca Bar poles	12	12	12	12	12	
Conduttori connettibili Connectable cables	2x4 mm ²	2x6 mm ²	2x10 mm ²	2x16 mm ²	2x25 mm ²	
Dimensioni Dimensions	A mm	96,2	116,8	140,5	169,8	195
	B mm	17	19,2	23,5	25	36
	C mm	14,5	16,7	18,7	20,8	26,1
	D mm	8,2	10	12	14,5	16,5
	Ø E mm	2,9	3,6	3,9	4,3	4,3
	Ø F mm	3,2	3,4	4,5	6,5	7
Certificazioni Certifications						



I morsetti della linea Boxterminal possono essere montati su guida DIN utilizzando il supporto art. **159SM**

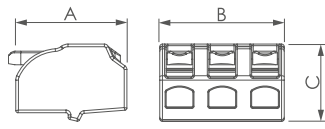

The terminals of the Boxterminal line can be mounted on a DIN rail using the support item **159SM**

HYBRID morsetti a levetta per cavi flessibili e rigidi HYBRID fast connectors for flexible and rigid cables

<p>Certificazioni: TUV Conformità: CE, RoHS 2015/863/EU Normative: EN 60998-1:2004 Materiale guscio: Polycarbonato Materiale inserto: Rame Elettrolitico Temperatura d'esercizio: -5°C +85°C Resistenza al calore: 130°C</p>	<p>Approvals: TUV Compliance: CE, RoHS 2015/863/EU Standards: EN 60998-1: 2004 Shell material: Polycarbonate Insert material: Electrolytic Copper Working temperature: -5°C +85°C Heat resistance: 130°C</p>	 
---	---	--

Articolo Item	Numero fori Holes number	Tensione Nominale Rated voltage	Grado di protezione Protection degree	Corrente nominale Rated current	Conduttori flessibili/rigidi Flexible/rigid conductors	Dimensioni Dimensions		
						A mm	B mm	C mm
BIW252	2	450 V	IP20	32 A	2 x 0,2÷4 mm ²	20	12	14
BIW253	3	450 V	IP20	32 A	3 x 0,2÷4 mm ²	20	16	14
BIW255	5	450 V	IP20	32 A	5 x 0,2÷4 mm ²	20	26	14

HYBRID morsetti a levetta per cavi flessibili e rigidi HYBRID fast connectors for flexible and rigid cables

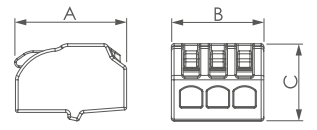
<p>Certificazioni: UL, ENEC Conformità: CE, RoHS 2015/863/EU Normative: EN 60998-1:2004 Materiale inserto: Rame Elettrolitico</p> <p>Materiale guscio: Polycarbonato Temperatura d'esercizio: -5°C +85°C Resistenza al calore: 130°C</p> <p>Materiale guscio: Poliammide Temperatura d'esercizio: -40°C +100°C Resistenza al calore: 140°C</p>	<p>Approvals: UL, ENEC Compliance: CE, RoHS 2015/863/EU Standards: EN 60998-1: 2004 Insert material: Electrolytic Copper</p> <p>Shell material: Polycarbonate Working temperature: -5°C +85°C Heat resistance: 130°C</p> <p>Shell material: Polyamide Working temperature: -40°C +100°C Heat resistance: 140°C</p>	  
---	---	---

Articolo Item	Numero fori Holes number	Tensione Nominale Rated voltage	Grado di protezione Protection degree	Corrente nominale Rated current	Conduttori flessibili/rigidi Flexible/rigid conductors	Dimensioni Dimensions		
						A mm	B mm	C mm
BIF252	2	450 V	IP20	32 A	2 x 0,2÷4 mm ²	22	14	15
BIF253	3	450 V	IP20	32 A	3 x 0,2÷4 mm ²	22	18	15
BIF255	5	450 V	IP20	32 A	5 x 0,2÷4 mm ²	22	28	15

Versione in poliammide grigio - Grey polyamide version

BIV402	2	450 V	IP20	32 A	2 x 0,2÷4 mm ²	22	14	15
BIV403	3	450 V	IP20	32 A	3 x 0,2÷4 mm ²	22	18	15
BIV405	5	450 V	IP20	32 A	5 x 0,2÷4 mm ²	22	28	15

MINIBOX morsetti a serraggio rapido per cavi rigidi MINIBOX push-in connectors for rigid wires

<p>Certificazioni: UL, FIMKO, VDE, KEMA Conformità: CE, RoHS 2015/863/EU Normative: EN 60998-1:2004 Materiale guscio: Policarbonato e poliammide Materiale inserto: Rame Elettrolitico Temperatura d'esercizio: -5°C +85°C Resistenza al calore: 130°C</p>	<p>Approvals: UL, FIMKO, VDE, KEMA Compliance: CE, RoHS 2015/863/EU Standards: EN 60998-1: 2004 Shell material: Polycarbonate and Polyamide Insert material: Electrolytic Copper Working temperature: -5°C +85°C Heat resistance: 130°C</p>	

Articolo Item	N. fori N. holes	Colore inserti lateral Lateral inserts color	Tensione Nominale Rated voltage	Grado di protezione Protection degree	Corrente nominale Rated current	Conduttori rigidi Rigid conductors	Dimensioni Dimensions		
							A mm	B mm	C mm
BIS252	2	Rosso Red	450 V	IP20	32 A	2 x 1÷2,5 mm ²	19	10	9
BIS253	3	Arancione Orange	450 V	IP20	32 A	3 x 1÷2,5 mm ²	19	13	9
BIS254	4	Giallo Yellow	450 V	IP20	32 A	4 x 1÷2,5 mm ²	19	17	9
BIS255	5	Grigio Grey	450 V	IP20	32 A	5 x 1÷2,5 mm ²	19	21	9
BIS258	8	Nero Black	450 V	IP20	32 A	8 x 1÷2,5 mm ²	19	17	17

MINIBOX morsetti a serraggio rapido per cavi rigidi MINIBOX push-in connectors for rigid wires

<p>Certificazioni: VDE, KEMA Conformità: CE, RoHS 2015/863/EU Normative: EN 60998-1:2004 Materiale guscio: Poliammide Materiale inserto: Rame Elettrolitico Temperatura d'esercizio: -40°C +100°C Resistenza al calore: 140°C</p>	<p>Approvals: VDE, KEMA Compliance: CE, RoHS 2015/863/EU Standards: EN 60998-1: 2004 Shell material: Polyamide Insert material: Electrolytic Copper Working temperature: -40°C +100°C Heat resistance: 140°C</p>	

Articolo Item	N. fori N. holes	Colore Color	Tensione Nominale Rated voltage	Grado di protezione Protection degree	Corrente nominale Rated current	Conduttori rigidi Rigid conductors	Dimensioni Dimensions		
							A mm	B mm	C mm
BIR253	3	Grigio Grey	450 V	IP20	32 A	3 x 1÷2,5 mm ²	19	15	9
BIR254	4		450 V	IP20	32 A	4 x 1÷2,5 mm ²	19	19	9
BIR255	5		450 V	IP20	32 A	5 x 1÷2,5 mm ²	19	22	9

EQUIJOINT morsettiere equipotenziali EQUIJOINT equipotential terminals

<p>Conformità: CE, RoHS 2015/863/EU Normative: EN 60998-1:2004 Materiale guscio: Poliammide Materiale inserto: Ottone/Acciaio Temperatura d'esercizio: -30°C +85°C Resistenza al calore: 150°C Compliance: CE, RoHS 2015/863/EU Standards: EN 60998-1: 2004 Shell material: Polyamide Insert material: Brass/Steel Working temperature: -30°C +85°C Heat resistance: 150°C</p>		
---	---	---

Articolo Item	N. fori N. holes	Dimensione fori Holes dimension	Sezione cavi collegabili Cable cross section	Dimensione conduttore tondo Dimension round conductor	Dimensione conduttore piatto Dimension flat conductor	Dimensioni Dimensions		
						A mm	B mm	C mm
TP309	7	7xØ 6,5 mm	7x16 mm ²	2xØ10 mm (78 mm ²)	1x30x3,5 mm (105 mm ²)	45	155	46

<p>Conformità: CE, RoHS 2015/863/EU Normative: EN 60998-1:2004 Materiale guscio: Poliammide Materiale inserto: Ottone/Acciaio Temperatura d'esercizio: -30°C +85°C Resistenza al calore: 150°C Compliance: CE, RoHS 2015/863/EU Standards: EN 60998-1: 2004 Shell material: Polyamide Insert material: Brass/Steel Working temperature: -30°C +85°C Heat resistance: 150°C</p>		
---	--	---

Articolo Item	N. fori N. holes	Dimensione fori Holes dimension	Sezione cavi collegabili Cable cross section	Dimensione conduttore tondo Dimension round conductor	Dimensione conduttore piatto Dimension flat conductor	Dimensioni Dimensions		
						A mm	B mm	C mm
TP2309	16	12xØ4,5 mm 4xØ6 mm	12x6 mm ² 4x16 mm ²	1xØ8 mm (50 mm ²)	-	45	155	46

<p>Conformità: CE, RoHS 2015/863/EU Normative: EN 60998-1:2004 Materiale inserto: Ottone/Acciaio Temperatura d'esercizio: -30°C +85°C Resistenza al calore: 150°C Compliance: CE, RoHS 2015/863/EU Standards: EN 60998-1: 2004 Insert material: Brass/Steel Working temperature: -30°C +85°C Heat resistance: 150°C</p>		
--	---	--

Articolo Item	N. fori N. holes	Dimensione fori Holes dimension	Sezione cavi collegabili Cable cross section	Dimensione conduttore tondo Dimension round conductor	Dimensione conduttore piatto Dimension flat conductor	Dimensioni Dimensions		
						A mm	B mm	C mm
T2309	16	12xØ4,5 mm 4xØ6 mm	12x6 mm ² 4x16 mm ²	1xØ8 mm (50 mm ²)	-	10	120	12

EQUIJOINT morsettiere equipotenziali EQUIJOINT equipotential terminals

<p>Certificazioni: IMQ Conformità: CE, RoHS 2015/863/EU Normative: EN 60998-1:2004 Materiale guscio: Poliammide Materiale inserto: Ottone/Rame Temperatura d'esercizio: -30°C +85°C Resistenza al calore: 150°C Certifications: IMQ Compliance: CE, RoHS 2015/863/EU Standards: EN 60998-1: 2004 Shell material: Polyamide Insert material: Brass/Copper Working temperature: -30°C +85°C Heat resistance: 150°C</p>		
---	--	--

Articolo Item	N. fori N. holes	Dimensione fori Holes dimension	Sezione cavi collegabili Cable cross section	Dimensione conduttore tondo Dimension round conductor	Dimensione conduttore piatto Dimension flat conductor	Dimensioni Dimensions		
						A mm	B mm	C mm
BT137	7	5xØ 5,3 mm 1xØ 6,9 mm 1xØ 8 mm	5x10 mm ² 1x16 mm ² 1x35 mm ²	2xØ10 mm (78 mm ²)	1x30x3,5 mm (105 mm ²)	45	155	46
BT1311	11	9xØ 5,3 mm 1xØ 6,9 mm 1xØ 8 mm	9x10 mm ² 1x16 mm ² 1x35 mm ²	2xØ10 mm (78 mm ²)	1x30x3,5 mm (105 mm ²)	45	192	46
BT1315	15	13xØ 5,3 mm 1xØ 6,9 mm 1xØ 8 mm	13x10 mm ² 1x16 mm ² 1x35 mm ²	2xØ10 mm (78 mm ²)	1x30x3,5 mm (105 mm ²)	45	222	46

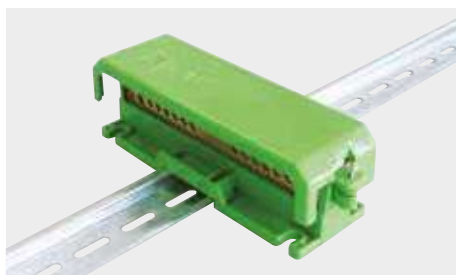

Tutte le morsettiere possono essere montate a scatto su guida DIN metallica (Omega3/Omega3A vedi pag. 206) o direttamente su piastra con viti. E' possibile applicare oltre ai cavi per la messa a terra, n.1/2 conduttori tondi max Ø10 mm, oppure n.1 conduttore piatto max 30x3,5 mm.

All the terminal blocks can be snap-mounted on a metallic DIN rail (Omega3 / Omega3A see page 206) or directly on a plate with screws. In addition to the grounding cables, it is possible to apply n.1/2 round conductors max Ø10 mm, or n.1 flat conductor max 30x3.5 mm.

<p>Certificazioni: IMQ Conformità: CE, RoHS 2015/863/EU Normative: EN 60998-1:2004 Materiale guscio: Poliammide Materiale inserto: Ottone/Rame Temperatura d'esercizio: -30°C +85°C Resistenza al calore: 150°C Certifications: IMQ Compliance: CE, RoHS 2015/863/EU Standards: EN 60998-1: 2004 Shell material: Polyamide Insert material: Brass/Copper Working temperature: -30°C +85°C Heat resistance: 150°C</p>		
---	--	--

Articolo Item	N. fori N. holes	Dimensione fori Holes dimension	Sezione cavi collegabili Cable cross section	Dimensione conduttore tondo Dimension round conductor	Dimensione conduttore piatto Dimension flat conductor	Dimensioni Dimensions		
						A mm	B mm	C mm
BT2309	16	12xØ 4,5 mm 4xØ6 mm	12x6 mm ² 4x16 mm ²	1xØ8 mm (50 mm ²)	-	45	155	46

EQUIJOINT morsettiere equipotenziali EQUIJOINT equipotential terminals

<p>Certificazioni: IMQ Conformità: CE, RoHS 2015/863/EU Normative: EN 60998-1:2004 Materiale guscio: Poliammide Materiale inserto: Ottone Approvals: IMQ Compliance: CE, RoHS 2015/863/EU Standards: EN 60998-1: 2004 Shell material: Polyamide Insert material: Brass</p>		
---	---	---

Articolo Item	Numero fori Holes number	Numero poli Number poles	Dimensione fori Holes dimension	Sezione cavi collegabili Cable cross section	Dimensioni Dimensions		
					A mm	B mm	C mm
T1614	14	2	4xØ 6 mm 10xØ 5,3 mm	4x16 mm ² 10x10 mm ²	51	47	39
T1628	30	2	4xØ 6 mm 26xØ 5,3 mm	4x16 mm ² 26x10 mm ²	105	47	39



EQUIJOINT morsettiere equipotenziali EQUIJOINT equipotential terminals

<p>Certificazioni: IMQ Conformità: CE, RoHS 2015/863/EU Normative: EN 60998-1:2004 Materiale guscio: Poliammide/Policarbonato Materiale inserto: Ottone Approvals: IMQ Compliance: CE, RoHS 2015/863/EU Standards: EN 60998-1: 2004 Shell material: Polyamide/Polycarbonate Insert material: Brass</p>		
---	---	---

Articolo Item	N. fori N. holes	Dimensione fori Holes dimension	Sezione cavi collegabili Cable cross section	Numero poli Number of poles	Dimensioni Dimensions				
					A mm	B mm	C mm	Ø D mm	Ø E mm
T167	7	2 x Ø 6 mm 5 x Ø 5,3 mm	2 x 16 mm ² 5 x 10 mm ²	1	19	59	34	6	5,3
T1611	11	2 x Ø 6 mm 9 x Ø 5,3 mm	2 x 16 mm ² 9 x 10 mm ²	1	19	88	34	6	5,3
T1615	15	2 x Ø 6 mm 13 x Ø 5,3 mm	2 x 16 mm ² 13 x 10 mm ²	1	19	114	34	6	5,3

EQUIJOINT barre equipotenziali EQUIJOINT equipotential bars

<p>Conformità: CE, RoHS 2015/863/EU Normative: EN 60998-1:2004 Materiale guscio: Poliammide Materiale Barre: Rame Temperatura d'esercizio: -30°C +85°C Resistenza al calore: 150°C Compliance: CE, RoHS 2015/863/EU Standards: EN 60998-1: 2004 Shell material: Polyamide Bars material: Copper Working temperature: -30°C +85°C Heat resistance: 150°C</p>		
--	--	--

Articolo Item	N. barre N. bars	Dimensione barre Dimension bars	N. fori e viti in dotazione N. holes and supplied screws	Interasse fori Holes step	A mm	B mm	C mm
BT20	2	12 x 2 mm	20 x M5	9,5 mm	128	47	24
BT34	2	12 x 2 mm	34 x M5	9,5 mm	195	47	24

Componenti singoli per la personalizzazione Single components for customization				
Articolo Item	Composizione Kit Composition Kit	Dimensioni Dimensions	Interasse fori Holes step	Oggetto Object
BTS122	N.2 supporti di fissaggio N.2 fixing supports	45 x 12 x 9 mm	56 mm (interasse barre) 56 mm (bars step)	
BCF1220-1	1 barra da 1 metro 1 bar of 1 meter	Barre 12 x 2 mm	9,5 mm (interasse viti) 9,5 mm (screws step)	
BBM590	1 sacchetto con 100 viti 1 bag with 100 screws	M5		

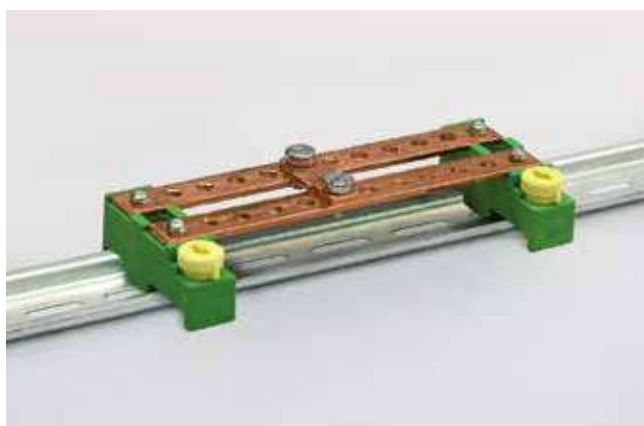

EQUIJOINT barre equipotenziali con coperchio EQUIJOINT equipotential bars with cover

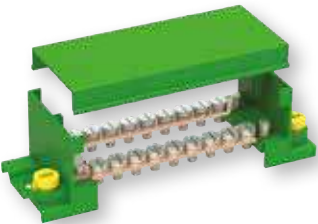
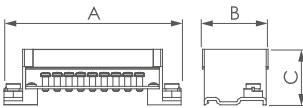
<p>Certificazioni: IMQ Conformità: CE, RoHS 2015/863/EU Normative: EN 60998-1:2004 Materiale guscio: Poliammide Materiale Barre: Rame Temperatura d'esercizio: -30°C +85°C Resistenza al calore: 150°C Certifications: IMQ Compliance: CE, RoHS 2015/863/EU Standards: EN 60998-1: 2004 Shell material: Polyamide Bars material: Copper Working temperature: -30°C +85°C Heat resistance: 150°C</p>		
--	---	---

Articolo Item	N. barre N. bars	Dimensione barre Bars dimension	N. fori e viti in dotazione N. holes and supplied screws	Interasse fori Holes step	A mm	B mm	C mm
TV122-18	2	12 x 2 mm	18 x M5	9,5 mm	140	50	45
TV124-18	2	12 x 4 mm	18 x M5	9,5 mm	140	50	45

Scatole per nodi equipotenziali Equipotential boxes

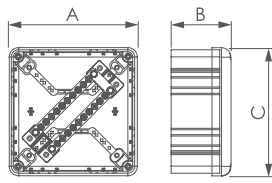
<p>Certificazioni: IMQ Conformità: CE, RoHS 2015/863/EU Normative: EN 60998-1:2004 Materiale scatola: Abs/Polycarbonato Materiale morsettiere: Ottone Certifications: IMQ Compliance: CE, RoHS 2015/863/EU Standards: EN 60998-1: 2004 Box material: Abs/Polycarbonate Terminal block material: Brass</p>		
--	---	---

Articolo Item	Numero fori Number holes	Filettatura fori Thread holes	N. Viti in dotazione Thread holes	Interasse fori Holes step	Numero e articolo morsettiere Terminals number and item	Dimensioni Dimensions		
						A mm	B mm	C mm
6700BT12.3	12	M5	20	9,5 mm	1 x BT12	115	53	115
6701BT20.3	20	M5	20	9,5 mm	1 x BT20	155	80	155
6702BT34.3	34	M5	40	9,5 mm	1 x BT34	200	80	200

Scatole per nodi equipotenziali Equipotential boxes

<p>Certificazioni: IMQ Conformità: CE, RoHS 2015/863/EU Normative: EN 60998-1:2004 Materiale scatola: Abs/Polycarbonato Materiale morsettiere: Ottone Certifications: IMQ Compliance: CE, RoHS 2015/863/EU Standards: EN 60998-1: 2004 Box material: Abs/Polycarbonate Terminal block material: Brass</p>		
--	--	--

Articolo Item	N. fori N. holes	Numero e articolo morsettiere Terminals number and item	Espansione possibile Possible extension	Diametro e sezione fori Diameter and hole section	Dimensioni Dimensions		
					A mm	B mm	C mm
6700TE14.3	14	2 x T167	2 x T167	10 x Ø5,3 mm (10 mm ²) 4 x Ø6,0 mm (16 mm ²)	115	53	115
6701TE28.3	30	2 x T1611	x T1611	26 x Ø5,3 mm (10 mm ²) 4 x Ø6,0 mm (16 mm ²)	155	80	155
6702TE56.3	60	4 x T1615	2 x T1615	52 x Ø5,3 mm (10 mm ²) 8 x Ø6,0 mm (16 mm ²)	200	80	200





Le scatole per nodi equipotenziali sono fornite con un numero standard di morsettiere come riportato in tabella, ma possono essere espanse con altre morsettiere. Le morsettiere vengono fissate all'interno della scatola a pressione utilizzando l'asola presente sulla base.

The equipotential boxes are supplied with a standard number of terminals as shown in the table, but they can be increased with other terminal blocks. The terminal blocks are fixed inside the pressure box using the slot on the base.

Morsettiere di ripartizione per quadri elettrici

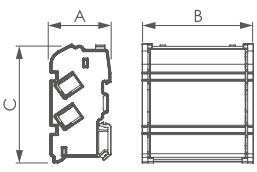
Distribution terminal posts for panels

<p>Certificazioni: IMQ, * UL Conformità: CE, RoHS 2015/863/EU Normative: EN 60998-1:2004 Materiale fiancate: Poliammide Materiale coperchio: Policarbonato Materiale Barre: Ottone Materiale viti: acciaio zincato Temperatura d'esercizio: -5°C +85°C Resistenza al calore: 130°C</p>	<p>Certifications: IMQ, * UL Compliance: CE, RoHS 2015/863/EU Standards: EN 60998-1: 2004 Sides material: Polyamide Cover material: Polycarbonate Bars material: Brass Screws material: zinc plated steel Working temperature: -5°C +85°C Heat resistance: 130°C</p>	
		

Articolo Item	Corrente nominale Rated current	Numero poli Number poles	N. fori per polo N. holes for pole	Dimensione fori per barra Dimension holes for bar	Sezione max per barra Max section for bar	I _{pk}	I _{cw}	U _{imp}	Potenza dissipata per barra Dissipated power per bar		Dimensioni Dimensions		
									kA	kA	kV	25°C	85°C
BR82.63	63 A	2	8	2xØ6 mm 6xØ5,3 mm	2x16 mm ² 6x10 mm ²	20	3	8	0,65W	0,76W	45	68	47
BR132.63	63 A	2	13	2xØ6 mm 11xØ5,3 mm	2x16 mm ² 11x10 mm ²	20	3	8	1,04W	1,23W	45	105	47
BR72.100 *	125 A	2	7	1xØ9 mm 1xØ8 mm 5xØ6 mm	1x35 mm ² 1x25 mm ² 5x10 mm ²	20	6	8	1,36W	1,46W	45	68	47
BR112.125	125 A	2	11	1xØ9 mm 2xØ8 mm 2xØ7 mm 6xØ6 mm	1x35 mm ² 2x25 mm ² 2x16 mm ² 6x10 mm ²	22	6	8	4,10W	4,85W	45	105	47
BR152.125 *	125 A	2	15	1xØ9 mm 2xØ8 mm 2xØ7 mm 10xØ6 mm	1x35 mm ² 2x25 mm ² 2x16 mm ² 10x10 mm ²	22	6	8	5,27W	6,30W	45	134	47

<p>Certificazioni: IMQ, * UL Conformità: CE, RoHS 2015/863/EU Normative: EN 60998-1:2004 Materiale fiancate: Poliammide Materiale coperchio: Policarbonato Materiale Barre: Ottone Materiale viti: acciaio zincato Temperatura d'esercizio: -5°C +85°C Resistenza al calore: 130°C</p>	<p>Certifications: IMQ, * UL Compliance: CE, RoHS 2015/863/EU Standards: EN 60998-1: 2004 Sides material: Polyamide Cover material: Polycarbonate Bars material: Brass Screws material: zinc plated steel Working temperature: -5°C +85°C Heat resistance: 130°C</p>												
BR84.63	63 A	4	8	2xØ6 mm 6xØ5,3 mm	2x16 mm ² 6x10 mm ²	20	3	8	0,65W	0,76W	45	72	98
BR134.63	63 A	4	13	2xØ6 mm 11xØ5,3 mm	2x16 mm ² 11x10 mm ²	20	3	8	1,04W	1,23W	45	109	98
BR74.100 *	125 A	4	7	1xØ9 mm 1xØ8 mm 5xØ6 mm	1x35 mm ² 1x25 mm ² 5x10 mm ²	20	6	8	1,36W	1,46W	45	72	98
BR114.125 *	125 A	4	11	1xØ9 mm 2xØ8 mm 2xØ7 mm 6xØ6 mm	1x35 mm ² 2x25 mm ² 2x16 mm ² 6x10 mm ²	22	6	8	4,10W	4,85W	45	109	98
BR154.125 *	125 A	4	15	1xØ9 mm 2xØ8 mm 2xØ7 mm 10xØ6 mm	1x35 mm ² 2x25 mm ² 2x16 mm ² 10x10 mm ²	22	6	8	5,27W	6,30W	45	138	98

Morsettiere di ripartizione per quadri elettrici

Distribution terminal posts for panels

<p>Certificazioni: IMQ Conformità: CE, RoHS 2015/863/EU Normative: EN 60998-1:2004 Materiale fiancate: Poliammide Materiale coperchio: Policarbonato Materiale Barre: Ottone Materiale viti: acciaio zincato Temperatura d'esercizio: -5°C +85°C Resistenza al calore: 130°C</p>	<p>Certifications: IMQ Compliance: CE, RoHS 2015/863/EU Standards: EN 60998-1: 2004 Sides material: Polyamide Cover material: Polycarbonate Bars material: Brass Screws material: zinc plated steel Working temperature: -5°C +85°C Heat resistance: 130°C</p>	

Articolo Item	Corrente nominale Rated current	Numero poli Number poles	N. fori per polo N. holes for pole	Dimensione fori per barra Dimension holes for bar	Max sezione per barra Max section for bar	I _{pk}	I _{cw}	U _{imp}	Potenza dissipata per barra Dissipated power per bar		Dimensioni Dimensions		
									25°C	85°C	A mm	B mm	C mm
BD10074	125 A	4	7	1xØ9 mm 1xØ8 mm 5xØ6 mm	1x35 mm ² 1x25 mm ² 5x10 mm ²	20	6	8	1,36W	1,46W	45	72	98
BD125114	125 A	4	11	1xØ9 mm 2xØ8 mm 2xØ7 mm 6xØ6 mm	1x35 mm ² 2x25 mm ² 2x16 mm ² 6x10 mm ²	22	6	8	4,10W	4,85W	45	109	98
BD125154	125 A	4	15	1xØ9 mm 2xØ8 mm 2xØ7 mm 10xØ6 mm	1x35 mm ² 2x25 mm ² 2x16 mm ² 10x10 mm ²	22	6	8	5,27W	6,30W	45	138	98

<p>Certificazioni: IMQ, UL Conformità: CE, RoHS 2015/863/EU Normative: EN 60998-1:2004 Materiale fiancate: Poliammide Materiale coperchio: Policarbonato Materiale Barre: Ottone Materiale viti: acciaio zincato Temperatura d'esercizio: -5°C +85°C Resistenza al calore: 130°C</p>	<p>Certifications: IMQ, UL Compliance: CE, RoHS 2015/863/EU Standards: EN 60998-1: 2004 Sides material: Polyamide Cover material: Polycarbonate Bars material: Brass Screws material: zinc plated steel Working temperature: -5°C +85°C Heat resistance: 130°C</p>												
BD16084	160 A	4	8	1xØ12 mm 1xØ9 mm 1xØ8 mm 5xØ7 mm	1x50 mm ² 1x35 mm ² 1x25 mm ² 5x16 mm ²	24	10	8	2,82W	3,17W	70	133	136
BD160134	160 A	4	13	1xØ12 mm 2xØ9 mm 2xØ8 mm 8xØ7 mm	1x50 mm ² 2x35 mm ² 2x25 mm ² 8x16 mm ²	24	10	8	4,39W	4,93W	70	186	136
BD160135	160 A	5	13	1xØ12 mm 2xØ9 mm 2xØ8 mm 8xØ7 mm	1x50 mm ² 2x35 mm ² 2x25 mm ² 8x16 mm ²	24	10	8	4,39W	4,93W	70	186	136

Barrette di espansione 5° polo

5° Pole expansion bars

Articolo Item	507N	5011N	5015N	BD1608	BD16013
Per morsettiere For terminals	7 fori/holes 125A	11 fori/holes 125A	15 fori/holes 125A	8 fori/holes 160A	13 fori/holes 160A
Info tec pagina 230 Info tec page 230					

BOXDIN 2 morsettiere di ripartizione per quadri elettrici

BOXDIN 2 distribution terminal posts for panels

<p>Certificazioni: IMQ Conformità: CE, RoHS 2015/863/EU Normative: EN 60998-1:2004 Materiale basi: Poliammide Materiale coperchio: Policarbonato Materiale Barre: Ottone Materiale viti: acciaio zincato Temperatura d'esercizio: -5°C +85°C Resistenza al calore: 130°C</p>	<p>Certifications: IMQ Compliance: CE, RoHS 2015/863/EU Standards: EN 60998-1: 2004 Bases material: Polyamide Cover material: Polycarbonate Bars material: Brass Screws material: zinc plated steel Working temperature: -5°C +85°C Heat resistance: 130°C</p>	
		

Articolo Item	Corrente nominale Rated current	Numero poli Number poles	N. fori per polo N. holes for pole	Dimensione fori per barra Dimension holes for bar	Max sezione per barra Max section for bar	I _{pk}	I _{cw}	U _{imp}	Potenza dissipata per barra Dissipated power per bar		Dimensioni Dimensions		
									25°C	85°C	A mm	B mm	C mm
BD5072	63 A	2	7	2xØ6 mm 5xØ5,3 mm	2x16 mm ² 5x10 mm ²	12	1,9	8	0,53W	0,63W	45	59	68
BD50112	63 A	2	11	2xØ6 mm 9xØ5,3 mm	2x16 mm ² 9x10 mm ²	12	1,9	8	0,83W	0,98W	45	88	68
BD5074	63 A	4	7	2xØ6 mm 5xØ5,3 mm	2x16 mm ² 5x10 mm ²	12	1,9	8	0,53W	0,63W	45	59	110
BD50114	63 A	4	11	2xØ6 mm 9xØ5,3 mm	2x16 mm ² 9x10 mm ²	12	1,9	8	0,83W	0,98W	45	88	110

<p>Certificazioni: IMQ Conformità: CE, RoHS 2015/863/EU Normative: EN 60998-1:2004 Materiale fiancate: Poliammide Materiale coperchio: Policarbonato Materiale Barre: Ottone Materiale viti: acciaio zincato Temperatura d'esercizio: -5°C +85°C Resistenza al calore: 130°C</p>	<p>Certifications: IMQ Compliance: CE, RoHS 2015/863/EU Standards: EN 60998-1: 2004 Sides material: Polyamide Cover material: Polycarbonate Bars material: Brass Screws material: zinc plated steel Working temperature: -5°C +85°C Heat resistance: 130°C</p>	
---	---	---

BD12574D	125 A	4	7	1xØ9 mm 1xØ8 mm 5xØ6 mm	1x35 mm ² 1x25 mm ² 5x10 mm ²	22	6	8	1,36W	1,46W	50	95	102
BD125114D	125 A	4	11	1xØ9 mm 2xØ8 mm 2xØ7 mm 6xØ6 mm	1x35 mm ² 2x25 mm ² 2x16 mm ² 6x10 mm ²	22	6	8	4,10W	4,85W	50	132	102
BD125154D	125 A	4	15	1xØ9 mm 2xØ8 mm 2xØ7 mm 10xØ6 mm	1x35 mm ² 2x25 mm ² 2x16 mm ² 10x10 mm ²	22	6	8	5,27W	6,30W	50	162	102
BD16084D	160 A	4	8	1xØ12 mm 1xØ9 mm 1xØ8 mm 5xØ7 mm	1x50 mm ² 1x35 mm ² 1x25 mm ² 5x16 mm ²	24	10	8	2,82W	3,17W	55	131	102
BD160134D	160 A	4	13	1xØ12 mm 2xØ9 mm 2xØ8 mm 8xØ7 mm	1x50 mm ² 2x35 mm ² 2x25 mm ² 8x16 mm ²	24	10	8	4,39W	4,93W	55	185	102
BD160184D	160 A	4	18	1xØ12 mm 2xØ9 mm 2xØ8 mm 9xØ7 mm 4xØ6 mm	1x50 mm ² 2x35 mm ² 2x25 mm ² 9x16 mm ² 4x10 mm ²	24	10	8	5,70W	6,40W	55	230	102

BOXDIN 3 morsettiere di ripartizione per quadri elettrici BOXDIN 3 distribution terminal posts for panels

<p>Certificazioni: IMQ Conformità: CE, RoHS 2015/863/EU Normative: EN 60998-1:2004 Materiale fiancate: Poliammide Materiale coperchio: Policarbonato Materiale Barre: Ottone Materiale viti: acciaio zincato Temperatura d'esercizio: -5°C +85°C Resistenza al calore: 130°C</p>	<p>Certifications: IMQ Compliance: CE, RoHS 2015/863/EU Standards: EN 60998-1: 2004 Sides material: Polyamide Cover material: Polycarbonate Bars material: Brass Screws material: zinc plated steel Working temperature: -5°C +85°C Heat resistance: 130°C</p>	

Articolo Item	Corrente nominale Rated current	Numero poli Number poles	N. fori per polo N. holes for pole	Dimensione fori per barra Dimension holes for bar	Max sezione per barra Max section for bar	I _{pk}	I _{cw}	U _{imp}	Potenza dissipata per barra Dissipated power for bar		Dimensioni Dimensions		
									25°C	85°C	A mm	B mm	C mm
BD125104	125 A	4	10 fori	1xØ9 mm 2xØ8 mm 2xØ7 mm 5xØ6 mm	1x35 mm ² 2x25 mm ² 2x16 mm ² 5x10 mm ²	22	6	8	4,0W	4,7W	45	149	103
BD125164	125 A	4	16 fori	1xØ9 mm 2xØ8 mm 2xØ7 mm 11xØ6 mm	1x35 mm ² 2x25 mm ² 2x16 mm ² 11x10 mm ²	22	6	8	5,5W	6,8W	45	201	103
BD160104	160 A	4	10 fori	1xØ12 mm 1xØ9 mm 1xØ8 mm 7xØ7 mm	1x50 mm ² 1x35 mm ² 1x25 mm ² 7x16 mm ²	24	10	8	3,0W	3,5W	45	165	103
BD160164	160 A	4	16 fori	1xØ12 mm 2xØ9 mm 2xØ8 mm 11xØ7 mm	1x50 mm ² 2x35 mm ² 2x25 mm ² 11x16 mm ²	24	10	8	5,0W	5,60W	70	228	103

Barrette di espansione 5° polo 5° Pole expansion bars

Articolo Item	BD12510	BD12516	BD16010	BD16016
Per morsettiere For terminals	10 fori/holes 125A	16 fori/holes 125A	10 fori/holes 160A	16 fori/holes 160A



Le morsettiere BOXDIN 2 si cablano da 2 lati, 2 barre a destra e 2 barre a sinistra

The terminal posts BOXDIN2 have a wiring system from 2 sides, 2 bars right and 2 bars left



Nelle morsettiere BOXDIN 3 il cablaggio del conduttore primario è separato dai cavi di distribuzione

In the terminal posts BOXDIN 3 the main wire is cabled separately from distribution wires

160A Ripartitori quadripolari Quadripolar distribution frames

Versione a scaletta con passo 19 mm

Ladder version with pitch 19 mm

Conformità: CE, RoHS 2015/863/EU
Normative: EN 60998-1:2004
Materiale supporti: Poliammide
Materiale coperchio: Pvc
Materiale Barre: Rame
Compliance: CE, RoHS 2015/863/EU
Standards: EN 60998-1: 2004
Supports material: Polyamide
Cover material: Pvc
Bars material: Copper

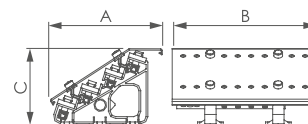
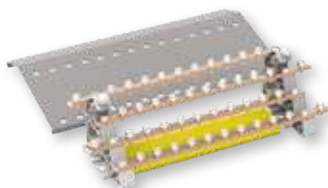

Articolo Item	Corrente nominale Rated current	Sezione barre Bars section	Numero fori per barra Holes number each bar	Numero viti e rondelle Screws and washers number	Distanza fra i supporti Distance between supports	I_{pk}	$I_{cc\ rms}$	$I_{cw\ ms\ I_s}$	U_i	U_{imp}	Potenza dissipata per barra Dissipated power for bar	Dimensioni Dimensions		
						kA	kA	kA	V	kV		A mm	B mm	C mm
BBD1606	160 A	15x4mm	6xM5	20xM5	114 mm	48	23	5	500	6	0,96W	135	190	74
BBD16011	160 A	15x4mm	11xM5	40xM5	209 mm	30	15	5	500	6	1,77W	135	280	74
BBD16017	160 A	15x4mm	17xM5	60xM5	171 mm	40	20	5	500	6	2,89W	135	420	74

Versione piana con passo 19 mm

Flat version with pitch 19 mm

Conformità: CE, RoHS 2015/863/EU
Normative: EN 60998-1:2004
Materiale supporti: Poliammide
Materiale coperchio: Policarbonato
Materiale Barre: Rame
Compliance: CE, RoHS 2015/863/EU
Standards: EN 60998-1: 2004
Supports material: Polyamide
Cover material: Polycarbonate
Bars material: Copper

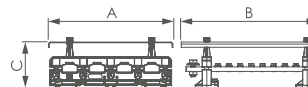
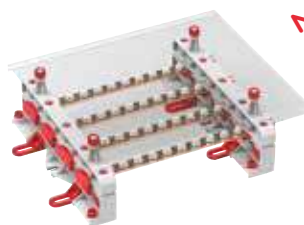

Articolo Item	Corrente nominale Rated current	Sezione barre Bars section	Numero fori per barra Holes number each bar	Numero viti e rondelle Screws and washers number	Distanza fra i supporti Distance between supports	I_{pk}	$I_{cc\ rms}$	$I_{cw\ ms\ I_s}$	U_i	U_{imp}	Potenza dissipata per barra Dissipated power for bar	Dimensioni Dimensions		
						kA	kA	kA	V	kV		A mm	B mm	C mm
BBS16006	160 A	15x4mm	6xM5	20xM5	114 mm	64	8	6	1000	12	0,96W	250	190	95
BBS16011	160 A	15x4mm	11xM5	40xM5	209 mm	56	6	6	1000	12	1,77W	250	280	95
BBS16017	160 A	15x4mm	17xM5	60xM5	171 mm	60	7	6	1000	12	2,89W	250	420	95

250A Ripartitori quadripolari Quadripolar distribution frames

Versione a scaletta con passo 19 mm

Ladder version with pitch 19 mm

Conformità: CE, RoHS 2015/863/EU
Normative: EN 60998-1:2004
Materiale supporti: Poliammide
Materiale coperchio: Pvc
Materiale Barre: Rame
Compliance: CE, RoHS 2015/863/EU
Standards: EN 60998-1: 2004
Supports material: Polyamide
Cover material: Pvc
Bars material: Copper

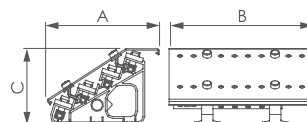
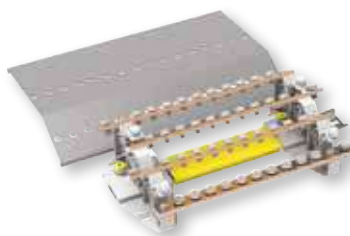

Articolo Item	Corrente nominale Rated current	Sezione barre Bars section	Numero fori per barra Holes number each bar	Numero viti e rondelle Screws and washers number	Distanza fra i supporti Distance between supports	I_{pk}	$I_{cc\ rms}$	$I_{ew\ ms\ s}$	U_i	U_{imp}	Potenza dissipata per barra Dissipated power for bar	Dimensioni Dimensions		
						kA	kA	kA	V	kV		A mm	B mm	C mm
BBD2506	250 A	20x5mm	1xM8 5xM6	4xM8 20xM6	114 mm	48	23	9	500	8	1,50W	190	190	67
BBD25011	250 A	20x5mm	1xM8 10xM6	4xM8 40xM6	209 mm	30	15	9	500	8	2,74W	190	280	67
BBD25017	250 A	20x5mm	1xM8 16xM6	4xM8 60xM6	171 mm	40	20	9	500	8	4,49W	190	420	67
BBD25027	250 A	20x5mm	1xM8 26xM6	4xM8 100xM6	190 mm	40	20	9	500	8	7,23W	190	630	67

Versione piana con passo 19 mm

Flat version with pitch 19 mm

Conformità: CE, RoHS 2015/863/EU
Normative: EN 60998-1:2004
Materiale supporti: Poliammide
Materiale coperchio: Policarbonato
Materiale Barre: Rame
Compliance: CE, RoHS 2015/863/EU
Standards: EN 60998-1: 2004
Supports material: Polyamide
Cover material: Polycarbonate
Bars material: Copper

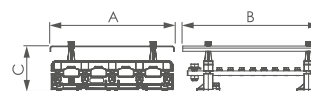
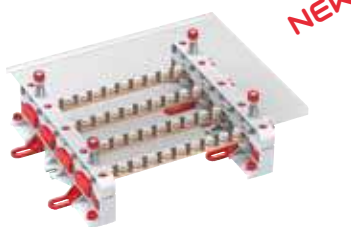

Articolo Item	Corrente nominale Rated current	Sezione barre Bars section	Numero fori per barra Holes number each bar	Numero viti e rondelle Screws and washers number	Distanza fra i supporti Distance between supports	I_{pk}	$I_{cc\ rms}$	$I_{ew\ ms\ s}$	U_i	U_{imp}	Potenza dissipata per barra Dissipated power for bar	Dimensioni Dimensions		
						kA	kA	kA	V	kV		A mm	B mm	C mm
BBS25006	250 A	20x5mm	1xM8 5xM6	4xM8 20xM6	114 mm	69	9	9	1000	12	1,50W	250	190	95
BBS25011	250 A	20x5mm	1xM8 10xM6	4xM8 40xM6	209 mm	60	9	9	1000	12	2,74W	250	280	95
BBS25017	250 A	20x5mm	1xM8 16xM6	4xM8 60xM6	171 mm	61	8	9	1000	12	4,49W	250	420	95
BBS25027	250 A	20x5mm	1xM8 26xM6	4xM8 100xM6	190 mm	61	8	9	1000	12	7,23W	250	630	95

250A Ripartitori quadripolari Quadripolar distribution frames

Versione a scaletta con passo 25 mm

Ladder version with pitch 25 mm

Conformità: CE, RoHS 2015/863/EU
Normative: EN 60998-1:2004
Materiale supporti: Poliammide
Materiale coperchio: Policarbonato
Materiale Barre: Rame
Compliance: CE, RoHS 2015/863/EU
Standards: EN 60998-1: 2004
Supports material: Polyamide
Cover material: Polycarbonate
Bars material: Copper

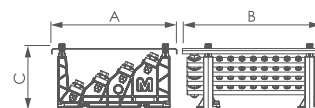
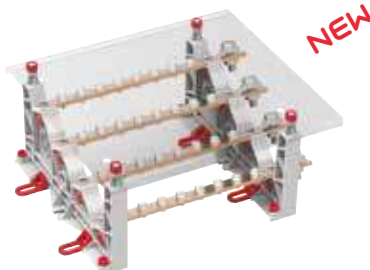

Articolo Item	Corrente nominale Rated current	Sezione barre Bars section	Numero fori per barra Holes number each bar	Numero viti e rondelle Screws and washers number	Distanza fra i supporti Distance between supports	I_{pk}	$I_{cc\ rms}$	$I_{cw\ ms\ IS}$	U_i	U_{imp}	Potenza dissipata per barra Dissipated power for bar	Dimensioni Dimensions		
						kA	kA	kA	V	kV		A mm	B mm	C mm
BBD25509	250 A	20x5mm	1xM8 8xM6	4xM10 20xM6	220 mm	30	15	9	500	8	2,74W	190	294	67
BBD25512	250 A	20x5mm	1xM8 11xM6	4xM10 40xM6	294 mm	30	15	9	500	8	3,00W	190	368	67
BBD25515	250 A	20x5mm	1xM8 14xM6	4xM10 60xM6	196 mm	40	20	9	500	8	4,70W	190	465	67
BBD25518	250 A	20x5mm	1xM8 17xM6	4xM10 100xM6	294 mm	30	15	9	500	8	6,90W	190	540	67

Versione piana con passo 25 mm

Flat version with pitch 25 mm

Conformità: CE, RoHS 2015/863/EU
Normative: EN 60998-1:2004
Materiale supporti: Poliammide
Materiale coperchio: Policarbonato
Materiale Barre: Rame
Compliance: CE, RoHS 2015/863/EU
Standards: EN 60998-1: 2004
Supports material: Polyamide
Cover material: Polycarbonate
Bars material: Copper

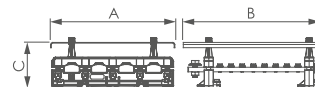
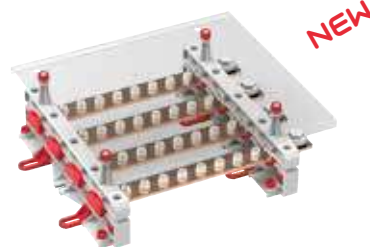

Articolo Item	Corrente nominale Rated current	Sezione barre Bars section	Numero fori per barra Holes number each bar	Numero viti e rondelle Screws and washers number	Distanza fra i supporti Distance between supports	I_{pk}	$I_{cc\ rms}$	$I_{cw\ ms\ IS}$	U_i	U_{imp}	Potenza dissipata per barra Dissipated power for bar	Dimensioni Dimensions		
						kA	kA	kA	V	kV		A mm	B mm	C mm
BBS25509	250 A	20x5mm	1xM8 8xM6	4xM10 20xM6	220 mm	54	9	9	1000	12	1,92W	275	294	95
BBS25512	250 A	20x5mm	1xM8 11xM6	4xM10 40xM6	294 mm	47	7	9	1000	12	3,00W	275	368	95
BBS25515	250 A	20x5mm	1xM8 14xM6	4xM10 60xM6	196 mm	61	8	9	1000	12	4,70W	275	465	95
BBS25518	250 A	20x5mm	1xM8 17xM6	4xM10 100xM6	294 mm	54	9	9	1000	12	6,90W	275	540	95

400A Ripartitori quadripolari Quadripolar distribution frames

Versione a scaletta con passo 19 mm

Ladder version with pitch 19 mm

Conformità: CE, RoHS 2015/863/EU
Normative: EN 60998-1:2004
Materiale supporti: Poliammide
Materiale coperchio: Pvc
Materiale Barre: Rame
Compliance: CE, RoHS 2015/863/EU
Standards: EN 60998-1: 2004
Supports material: Polyamide
Cover material: Pvc
Bars material: Copper

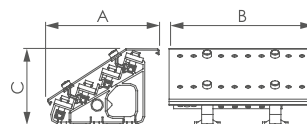
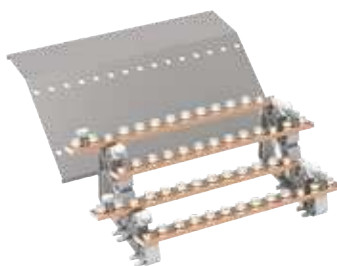

Articolo Item	Corrente nominale Rated current	Sezione barre Bars section	Numero fori per barra Holes number each bar	Numero viti e rondelle Screws and washers number	Distanza fra i supporti Distance between supports	I_{pk}	$I_{cc\ rms}$	$I_{cw\ ms\ 1s}$	U_i	U_{imp}	Potenza dissipata per barra Dissipated power for bar	Dimensioni Dimensions		
						kA	kA	kA	V	kV		A mm	B mm	C mm
BB4006	400 A	25x6mm	1xM8 5xM6	4xM8 20xM6	95 mm	52	25	14	500	8	2,83W	175	210	110
BB40011	400 A	25x6mm	1xM8 10xM6	4xM8 40xM6	190 mm	30	15	14	500	8	5,18W	175	300	110
BB40017	400 A	25x6mm	1xM8 16xM6	4xM8 60xM6	152 mm	48	23	14	500	8	8,48W	175	420	110
BB40027	400 A	25x6mm	1xM8 26xM6	4xM8 100xM6	171 mm	40	20	14	500	8	13,66W	175	630	110

Versione piana con passo 19 mm

Flat version with pitch 19 mm

Conformità: CE, RoHS 2015/863/EU
Normative: EN 60998-1:2004
Materiale supporti: Poliammide
Materiale coperchio: Policarbonato
Materiale Barre: Rame
Compliance: CE, RoHS 2015/863/EU
Standards: EN 60998-1: 2004
Supports material: Polyamide
Cover material: Polycarbonate
Bars material: Copper

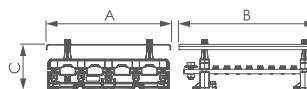
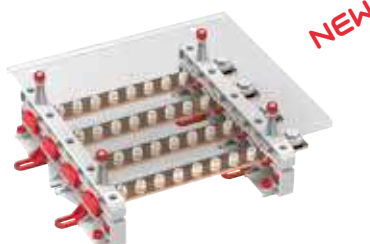

Articolo Item	Corrente nominale Rated current	Sezione barre Bars section	N. fori per barra N. holes for bar	N. viti e rondelle N. screws and washers	Distanza fra i supporti Distance between supports	I_{pk}	$I_{cc\ rms}$	$I_{cw\ ms\ 1s}$	U_i	U_{imp}	Potenza dissipata per barra Dissipated power for bar	Dimensioni Dimensions		
						kA	kA	kA	V	kV		A mm	B mm	C mm
BBS41906	400 A	25x6mm	1xM8 5xM6	4xM10 20xM6	95 mm	85	11	14	1000	12	2,83W	250	210	95
BBS41911	400 A	25x6mm	1xM8 10xM6	4xM10 40xM6	190 mm	72	15	14	1000	12	5,18W	250	300	95
BBS41917	400 A	25x6mm	1xM8 16xM6	4xM10 60xM6	152 mm	79	10	14	1000	12	8,48W	250	420	95
BBS41927	400 A	25x6mm	1xM8 26xM6	4xM10 100xM6	171 mm	72	10	14	1000	12	13,66W	250	630	95

400A Ripartitori quadripolari Quadripolar distribution frames

Versione a scaletta con passo 25 mm

Ladder version with pitch 25 mm

Conformità: CE, RoHS 2015/863/EU
Normative: EN 60998-1:2004
Materiale supporti: Poliammide
Materiale coperchio: Policarbonato
Materiale Barre: Rame
Compliance: CE, RoHS 2015/863/EU
Standards: EN 60998-1: 2004
Supports material: Polyamide
Cover material: Polycarbonate
Bars material: Copper

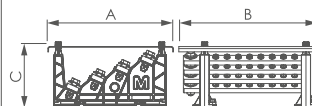
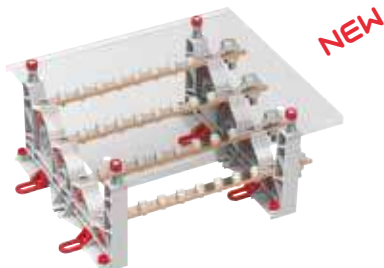

Articolo Item	Corrente nominale Rated current	Sezione barre Bars section	Numero fori per barra Holes number each bar	Numero viti e rondelle Screws and washers number	Distanza fra i supporti Distance between supports	I_{pk}	$I_{cc\ rms}$	$I_{cw\ ms1S}$	U_i	U_{imp}	Potenza dissipata per barra Dissipated power for bar	Dimensioni Dimensions		
						kA	kA	kA	V	kV		A mm	B mm	C mm
BDD40009	400 A	30x5 mm	8xM6 1xØ10,5mm	4 x M10 20 x M6	220 mm	60	15	15	1000	12	7,00W	275	294	145
BDD40012	400 A	30x5 mm	11xM6 1xØ10,5mm	4 x M10 40 x M6	294 mm	50	16	15	1000	12	9,18W	275	368	145
BDD40015	400 A	30x5 mm	14xM6 1xØ10,5mm	4 x M10 60 x M6	367 mm	40	13	15	1000	12	11,29W	275	441	145
BDD40018	400 A	30x5 mm	17xM6 1xØ10,5mm	4 x M10 100 x M6	441 mm	60	15	15	1000	12	13,40W	275	515	145

Versione a scaletta con passo 25x2 mm e fori disassati

Ladder version with pitch 25x2 mm and offset holes

Conformità: CE, RoHS 2015/863/EU
Normative: EN 60998-1:2004
Materiale supporti: Poliammide
Materiale coperchio: Policarbonato
Materiale Barre: Rame
Compliance: CE, RoHS 2015/863/EU
Standards: EN 60998-1: 2004
Supports material: Polyamide
Cover material: Polycarbonate
Bars material: Copper

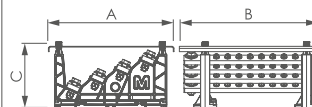
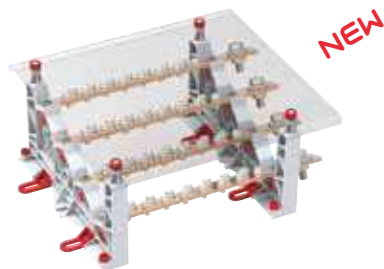

Articolo Item	Corrente nominale Rated current	Sezione barre Bars section	Numero fori per barra Holes number each bar	Numero viti e rondelle Screws and washers number	Distanza fra i supporti Distance between supports	I_{pk}	$I_{cc\ rms}$	$I_{cw\ ms1S}$	U_i	U_{imp}	Potenza dissipata per barra Dissipated power for bar	Dimensioni Dimensions		
						kA	kA	kA	V	kV		A mm	B mm	C mm
BDD40016	400 A	30x5mm	15xM6 1xØ10,5mm	4xM10 20xM6	220 mm	60	15	15	1000	12	7,00W	275	294	145
BDD40022	400 A	30x5mm	21xM6 1xØ10,5mm	4xM10 40xM6	294 mm	50	16	15	1000	12	9,18W	275	368	145

400A Ripartitori quadripolari Quadripolar distribution frames

Versione piana con passo **25 mm**

Flat version with pitch **25 mm**

Conformità: CE, RoHS 2015/863/EU
Normative: EN 60998-1:2004
Materiale supporti: Poliammide
Materiale coperchio: Policarbonato
Materiale Barre: Rame
Compliance: CE, RoHS 2015/863/EU
Standards: EN 60998-1: 2004
Supports material: Polyamide
Cover material: Polycarbonate
Bars material: Copper

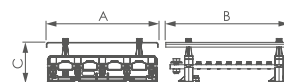
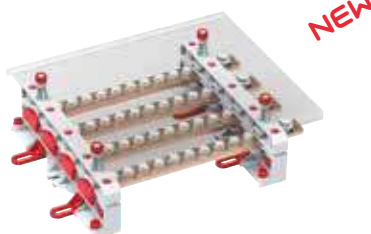

Articolo Item	Corrente nominale Rated current	Sezione barre Bars section	Numero fori per barra Holes number each bar	Numero viti e rondelle Screws and washers number	Distanza fra i supporti Distance between supports	I_{pk}	$I_{cc\ rms}$	$I_{cw\ ms\ S}$	U_i	U_{imp}	Potenza dissipata per barra Dissipated power for bar	Dimensioni Dimensions		
						kA	kA	kA	V	kV		A mm	B mm	C mm
BBS40009	400 A	30x5mm	8xM6 1xØ10,5mm	4xM10 20xM6	220 mm	52	7	15	1000	12	7,00W	275	294	110
BBS40012	400 A	30x5mm	11xM6 1xØ10,5mm	4xM10 40xM6	294 mm	46	16	15	1000	12	9,18W	275	368	110
BBS40015	400 A	30x5mm	14xM6 1xØ10,5mm	4xM10 60xM6	367 mm	42	7	15	1000	12	11,29W	275	441	110
BBS40018	400 A	30x5mm	17xM6 1xØ10,5mm	4xM10 100xM6	441 mm	41	6	15	1000	12	13,40W	275	515	110

Versione piana con passo **25x2 mm** e fori disassati

Flat version with pitch **25x2 mm** and offset holes

Conformità: CE, RoHS 2015/863/EU
Normative: EN 60998-1:2004
Materiale supporti: Poliammide
Materiale coperchio: Policarbonato
Materiale Barre: Rame
Compliance: CE, RoHS 2015/863/EU
Standards: EN 60998-1: 2004
Supports material: Polyamide
Cover material: Polycarbonate
Bars material: Copper

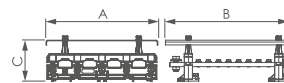
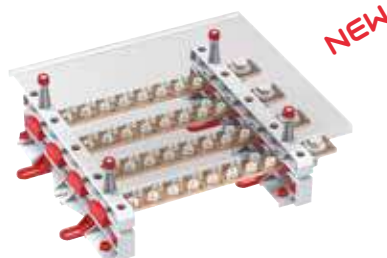

Articolo Item	Corrente nominale Rated current	Sezione barre Bars section	Numero fori per barra Holes number each bar	Numero viti e rondelle Screws and washers number	Distanza fra i supporti Distance between supports	I_{pk}	$I_{cc\ rms}$	$I_{cw\ ms\ S}$	U_i	U_{imp}	Potenza dissipata per barra Dissipated power for bar	Dimensioni Dimensions		
						kA	kA	kA	V	kV		A mm	B mm	C mm
BDS40016	400 A	30x5mm	15xM6 1xØ10,5mm	4xM10 60xM6	220 mm	52	7	15	1000	12	7,00W	275	294	110
BDS40022	400 A	30x5mm	21xM6 1xØ10,5mm	4xM10 100xM6	294 mm	46	16	15	1000	12	9,18W	275	368	110

630A Ripartitori quadripolari Quadripolar distribution frames

Versione a scaletta con passo 25 mm

Ladder version with pitch 25 mm

Conformità: CE, RoHS 2015/863/EU
Normative: EN 60998-1:2004
Materiale supporti: Poliammide
Materiale coperchio: Policarbonato
Materiale Barre: Rame
Compliance: CE, RoHS 2015/863/EU
Standards: EN 60998-1: 2004
Supports material: Polyamide
Cover material: Polycarbonate
Bars material: Copper

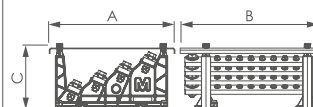
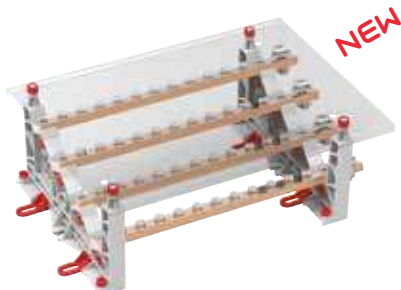

Articolo Item	Corrente nominale Rated current	Sezione barre Bars section	N. fori per barra N. holes for bar	N. viti e rondelle N. screws and washers	Distanza fra i supporti Distance between supports	I_{pk}	$I_{c,rms}$	$I_{w,rms}$	U_i	U_{imp}	Potenza dissipata per barra Dissipated power for bar	Dimensioni Dimensions		
						kA	kA	kA	V	kV		A mm	B mm	C mm
BBD63009	630 A	30x10 mm	8 x M6 1xØ10,5mm	4xM10 20xM6	220 mm	75	29	29	1000	12	8,75W	275	294	145
BBD63012	630 A	30x10 mm	11xM6 1x Ø10,5mm	4xM10 40xM6	294 mm	66	20	29	1000	12	11,40W	275	368	145
BBD63015	630 A	30x10 mm	14 x M6 1xØ10,5mm	4xM10 60xM6	367 mm	57	17	29	1000	12	14,00W	275	441	145
BBD63018	630 A	30x10 mm	18 x M6 1xØ10,5mm	4xM10 100xM6	441 mm	47	23	29	1000	12	16,60W	275	515	145

Versione piana con passo 25 mm

Flat version with pitch 25 mm

Conformità: CE, RoHS 2015/863/EU
Normative: EN 60998-1:2004
Materiale: Poliammide/Policarbonato
Materiale Barre: Rame
Compliance: CE, RoHS 2015/863/EU
Standards: EN 60998-1: 2004
Material: Polyamide/Policarbonate
Bars material: Copper

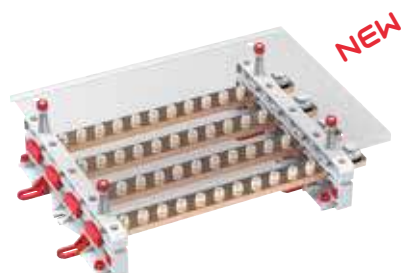

Articolo Item	Corrente nominale Rated current	Sezione barre Bars section	N. fori per barra N. holes for bar	N. viti e rondelle N. screws and washers	Distanza fra i supporti Distance between supports	I_{pk}	$I_{c,rms}$	$I_{w,rms}$	U_i	U_{imp}	Potenza dissipata per barra Dissipated power for bar	Dimensioni Dimensions		
						kA	kA	kA	V	kV		A mm	B mm	C mm
BBS63009	630 A	30x10mm	8xM6 1xØ 10,5mm	4 x M10 20 x M6	220 mm	86	12	29	1000	12	8,75W	275	294	110
BBS63012	630 A	30x10mm	11xM6 1xØ 10,5mm	4 x M10 40 x M6	294 mm	78	10	29	1000	12	11,40W	275	368	110
BBS63015	630 A	30x10mm	14xM6 1xØ 10,5mm	4 x M10 60 x M6	367 mm	71	10	29	1000	12	14,00W	275	441	110
BBS63018	630 A	30x10mm	17xM6 1xØ 10,5mm	4 x M10 100 x M6	441 mm	62	29	29	1000	12	16,60W	275	515	110

Barre in rame filettate Threaded copper bars

		Articolo Item	Dimensioni Dimension	Lunghezza Length	Corrente Nominale Rated current	Passo Pitch	Filettatura Thread
		BCF122-1	12x2 mm	1,00 m	65A	19 mm	M5
		BCF122	12x2 mm	2,00 m	65A	19 mm	M5
		BCF124-1	12x4 mm	1,00 m	125A	19 mm	M5
		BCF124	12x4 mm	1,75 m	125A	19 mm	M5
		BCF124-2	12x4 mm	2,00 m	125A	19 mm	M5
		BCF154-1	15x4 mm	1,00 m	160A	19 mm	M5
		BCF154	15x4 mm	1,75 m	160A	19 mm	M5
		BCF154-2	15x4 mm	2,00 m	160A	19 mm	M5
		BCF205-1	20x5 mm	1,00 m	250A	19 mm	M6
		BCF205	20x5 mm	1,75 m	250A	19 mm	M6
		BCF205-2	20x5 mm	2,00 m	250A	19 mm	M6
		BCF255-1	20x5 mm	1,00 m	250A	25 mm	M6
		BCF255	20x5 mm	1,75 m	250A	25 mm	M6
		BCF255-2	20x5 mm	2,00 m	250A	25 mm	M6
		BCF256-1	25x6 mm	1,00 m	400A	19 mm	M6
		BCF256	25x6 mm	1,75 m	400A	19 mm	M6
		BCF256-2	25x6 mm	2,00 m	400A	19 mm	M6
		BCF305-1	30x5 mm	1,00 m	400A	25 mm	M6
		BCF305	30x5 mm	1,75 m	400A	25 mm	M6
		BCF305-2	30x5 mm	2,00 m	400A	25 mm	M6
		BCF325-1	30x5 mm	1,00 m	400A	25x2 mm	M6
		BCF325	30x5 mm	1,75 m	400A	25x2 mm	M6
		BCF325-2	30x5 mm	2,00 m	400A	25x2 mm	M6
		BCF310-1	30x10 mm	1,00 m	630A	25 mm	M6
		BCF310	30x10 mm	1,75 m	630A	25 mm	M6
		BCF310-2	30x10 mm	2,00 m	630A	25 mm	M6

Supporti a scaletta Ladder holders

Articolo Item	Per barre For bars	Corrente nominale Rated current	Materiale Material	Fissaggio Fixing
	BB416 12x4 mm 15x4 mm	125 A 160 A	Poliammide Polyamide	Con vite o su guida DIN With screw or on DIN rail
	BB420 20x5 mm	250 A	Poliammide Polyamide	Con vite o su guida DIN With screw or on DIN rail
	BB425 25x6 mm	400 A	Poliammide Polyamide	Con vite With screw
	BB430 30x5 mm 30x10mm	400 A 630 A	Poliammide Polyamide	Con vite o su guida DIN With screw or on DIN rail

Supporti piani Flat holders

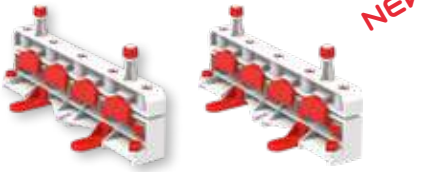
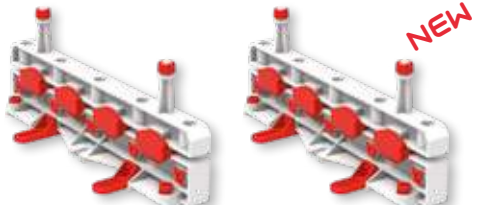
	BS420 15x4 mm 20x5 mm 25x6 mm	160 A 250 A 400 A	Poliammide Polyamide	Con vite o su guida DIN With screw or on DIN rail
	BS430 30x5 mm 30x10 mm	400 A 630 A	Poliammide Polyamide	Con vite o su guida DIN With screw or on DIN rail

Coperchi di protezione Protection cover

Articolo Item	Per supporto For holder	Materiale Material	Colore Colour	Lunghezza Length	
	BB2150	BB416	PVC	Grigio Grey	1m
	BB2250	BB420	PVC	Grigio Grey	1m
	BB2200	BB425	PVC	Grigio Grey	1m
NEW 	BS2275	BB430 BS420 BS430	Polycarbonato Polycarbonate	Trasparente Transparent	1m

Copriguida DIN L 1m Din rail cover L 1 m

Articolo Item	Per guida For rail	Materiale Material
NEW 	BCDIN Omega 3 Omega 3A	PVC

Viti con rondelle Screws and washers

Articolo Item	Dimensione Dimension	Materiale Material
	BBM59	M5 x 9 mm
	BBM610	M6 x 10 mm
	BBM612	M6 x 12 mm
		Acciaio zincato Zinc plated steel

Isolatori portabarre Insulating bar holder

Articolo Item	BP25M6	BP30M8	BP35M8	BP50M8	BP75M10	
Altezza Height	25 mm	30 mm	35 mm	50 mm	75 mm	
Filettatura Thread	M6	M8	M8	M8	M10	

Morsettiera di derivazione Universal derivation terminal

Articolo Item	BCFD	
Materiale Material	Ottone Brass	
Numero fori morsettiera Number of terminal block holes	7	
Sezione fori mm ² Holes section mm ²	16 mm ²	
Fori occupati sulla barra di rame Holes occupied on the copper bar	4 fori	



BOXDIS morsetti di ripartizione per quadri elettrici BOXDIS distribution terminal blocks for electrical panels

<p>Certificazioni: VDE Conformità: CE, RoHS 2015/863/EU Normative: EN 60998-1:2004 Materiale guscio: Poliammide Materiale Barre: Ottone Temperatura d'esercizio: -5°C +85°C Resistenza al calore: 130°C Certifications: IMQ Compliance: CE, RoHS 2015/863/EU Standards: EN 60998-1: 2004 Shell material: Polyamide Bars material: Brass Working temperature: -5°C +85°C Heat resistance: 130°C</p>										
Articolo Item	Corrente nominale Rated current	Numero poli Number poles	N. fori per polo N. holes for pole	Dimensione fori Dimension holes	Sezione fori Holes cross section	Coppia serraggio Tightening torque	Colore Colour	Dimensioni Dimensions		
						Nm		A mm	B mm	C mm
BKB251	100 A	1	2 + 2	2 x Ø6 mm 2 x Ø6,6 mm	16/25 mm ²	2,5	Grigio Grey	24	43	37
BKB251V	100 A	1	2 + 2	2 x Ø6 mm 2 x Ø6,6 mm	16/25 mm ²	2,5	Verde Green	24	43	37
BKB251N	100 A	1	2 + 2	2 x Ø6 mm 2 x Ø6,6 mm	16/25 mm ²	2,5	Blu Blue	24	43	37
BKB253	100 A	3	2 + 2	2 x Ø6 mm 2 x Ø6,6 mm	16/25 mm ²	2,5	Grigio Grey	61	43	37
BKB254	100 A	4	2 + 2	2 x Ø6 mm 2 x Ø6,6 mm	16/25 mm ²	2,5	Grigio Grey	83	43	37

BOXDIS morsettiere di ripartizione per quadri elettrici BOXDIS distribution terminal blocks for electrical panels

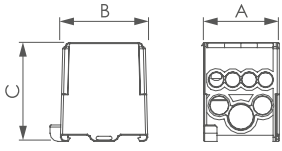
<p>Certificazioni: IMQ Conformità: CE, RoHS 2015/863/EU Normative: EN 60998-1:2004 Materiale guscio: Poliammide Materiale Barre: Ottone Temperatura d'esercizio: -5°C +85°C Resistenza al calore: 130°C Certifications: IMQ Compliance: CE, RoHS 2015/863/EU Standards: EN 60998-1: 2004 Shell material: Polyamide Bars material: Brass Working temperature: -5°C +85°C Heat resistance: 130°C</p>													
Articolo Item	Corrente nominale Rated current	Numero poli Number poles	N. fori per polo N. holes for pole	Dimensione fori Dimension holes	Sezione fori Max section for bar	Coppia serraggio Tightening torque	I _{pk}	I _{cw}	I _{cc}	U _{imp}	Dimensioni Dimensions		
						Nm					kA	kA	kA
BKB12511	125 A	1	11	1 x Ø9 mm 2 x Ø7 mm 8 x Ø5,5 mm	1 x 35 mm ² 2 x 25 mm ² 8 x 10 mm ²	4,4 - 2,7	20	6	10	8	35	43	45
BKB16011	160 A	1	11	1 x Ø12 mm 2 x Ø9 mm 8 x Ø7 mm	1 x 50 mm ² 2 x 35 mm ² 8 x 16 mm ²	- 4,4 2,7	24	10	12	8	40	43	45

BOXDIS morsettiere di ripartizione per quadri elettrici BOXDIS distribution terminal blocks for electrical panels





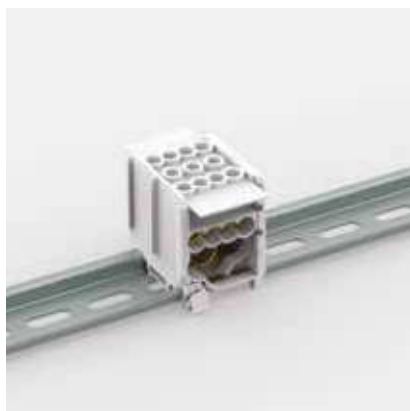
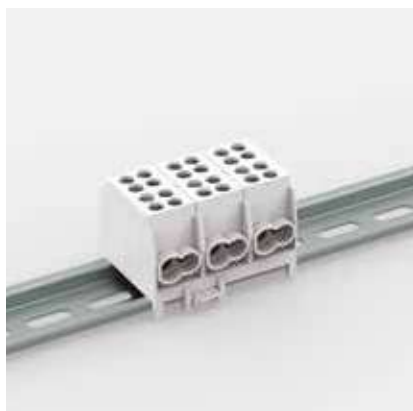







<p>Conformità: CE, RoHS 2015/863/EU Normative: EN 60998-1:2004 Materiale guscio: Poliammide/Polycarbonato Materiale Barre: Ottone Temperatura d'esercizio: -5°C +85°C Resistenza al calore: 130°C Compliance: CE, RoHS 2015/863/EU Standards: EN 60998-1: 2004 Shell material: Polyamide/Polycarbonate Bars material: Brass Working temperature: -5°C +85°C Heat resistance: 130°C</p>		
---	--	--

Articolo Item	Corrente nominale Rated current	Numero poli Number poles	N. fori per polo N. holes for pole	Dimensione fori Dimension holes	Sezione fori Max section for bar	Coppia serraggio Tightening torque	I _{pk}	I _{cw}	Dimensioni Dimensions		
						Nm			kA	kA	A mm
BKB0807	80 A	1	7	3 x Ø6,8 mm 4 x Ø4,5 mm	3 x 16 mm ² 4 x 6 mm ²	3,5 1,2	22	3	27	66	46
BKB12508	125 A	1	8	1 x Ø10 mm 7 x Ø6,8 mm	1 x 35 mm ² 7 x 16 mm ²	8,5 3,5	30	4,2	29	77	46
BKB16008	160 A	1	8	1 x Ø12,3 mm 7 x Ø6,8 mm	1 x 70 mm ² 7 x 16 mm ²	8,5 3,5	30	11,8	29	77	46
BKB25012	250 A	1	12	1 x Ø15 mm 2 x Ø9 mm 5 x Ø7 mm 4 x Ø6 mm	1 x 120 mm ² 2 x 35 mm ² 5 x 16 mm ² 4 x 10 mm ²	19 4,4 2,7 2,7	51	24,5	46	96	50
BKB40012	400 A	1	12	1 x Ø19 mm 2 x Ø9 mm 5 x Ø7 mm 4 x Ø6 mm	1 x 185 mm ² 2 x 35 mm ² 5 x 16 mm ² 4 x 10 mm ²	25 4,4 2,7 2,7	51	24,5	46	96	50
BKB50012	500 A	1	12	8 x 24 mm 2 x Ø9 mm 5 x Ø7 mm 4 x Ø6 mm	Flexible busbar 2 x 35 mm ² 5 x 16 mm ² 4 x 10 mm ²	10 4,4 2,7 2,7	51	24,5	46	96	50



Tutte le morsettiere della linea Boxdis possono essere montate su guida DIN Omega3 oppure direttamente su piastra con viti di fissaggio.
 All the terminal blocks of the Boxdis line can be mounted on a DIN Omega3 guide or directly on a plate with fixing screws.















Morsetti con serraggio a vite Screw clamp terminal blocks

Conformità: CE, RoHS 2015/863/EU Normative: IEC60947-7-1, UL1059, CSA22.2-158 Infiammabilità: UL94V0 Temperatura di esercizio: -40°C +80°C Resistenza al calore: 100°C				Compliance: CE, RoHS 2015/863/EU Standards: IEC60947-7-1, UL1059, CSA22.2-158 Flammability: UL94V0 Working temperature: -40°C +80°C Heat resistance: 100°C									
Immagine prodotto Product image													
Articolo Item	Grigio/Grey	CTS2.5UN	CTS4UN	CTS6U	CTS10U								
	Blu/Blue	CTS2.5UNBU	CTS4UNBU	CTS6UBU	CTS10UBU								
Schema di collegamento Connection diagram													
Dimensioni Dimensions	H x L x S	46.2 x 43 x 5 mm	46.2 x 43.0 x 6 mm	47.8 x 43.0 x 8 mm	47.8 x 43.0 x 10 mm								
Conduttori connettibili per foro Connection Possibility each hole	Flessibili Flexible	1 x 0.25 ÷ 2.5 mm ² 2 x 0.25 ÷ 1.5 mm ²	1 x 0.25 ÷ 4.0 mm ² 2 x 0.25 ÷ 2.5 mm ²	1 x 0.5 ÷ 6.0 mm ² 2 x 0.5 ÷ 4.0 mm ²	1 x 0.5 ÷ 10.0 mm ² 2 x 0.5 ÷ 6.0 mm ²								
	Rigidi Solid	1 x 0.25 ÷ 4.0 mm ²	1 x 0.25 ÷ 6.0 mm ²	-	-								
	Con terminale With ferrule/lug	1 x 0.25 ÷ 2.5 mm ² 2 x 0.25 ÷ 1.5 mm ²	1 x 0.25 ÷ 4.0 mm ² 2 x 0.25 ÷ 2.5 mm ²	1 x 0.5 ÷ 6.0 mm ² 2 x 0.5 ÷ 4.0 mm ²	1 x 0.5 ÷ 10.0 mm ² 2 x 0.5 ÷ 6.0 mm ²								
Lunghezza spelatura cavo Cable stripping length		8 mm	8 mm	9 mm	11 mm								
Materiale isolante Insulating material		Poliamide 6.6 Polyamide 6.6		Poliamide 6.6 Polyamide 6.6									
Normativa di riferimento Reference standard		IEC	UL	CSA	IEC	UL	CSA	IEC	UL	CSA	IEC	UL	CSA
Tensione nominale Voltage Rating		1000 V	600 V	600 V	1000 V	600 V	600 V	1000 V	600 V	600 V	1000 V	600 V	600 V
Corrente nominale Current Rating		24 A	25 A	25 A	32 A	35 A	35 A	41 A	50 A	50 A	57 A	65 A	65 A
Coppia di serraggio Tightening torque range		0,4 Nm	7 lb-in	7 lb-in	0,5 Nm	7 lb-in	7 lb-in	0,8 Nm	14 lb-in	14 lb-in	1,2 Nm	14 lb-in	14 lb-in
Certificazioni Certifications													
Terminale End plate		EP2.5/4UN		EP2.5/4UN		EP6/10U		EP6/10U		EP6/10U		EP6/10U	
Diaframma Partition plate		PP2.5/4UN		PP2.5/4UN		PP6/10U		PP6/10U		PP6/10U		PP6/10U	
Separatore Separator plate		SP2.5/4UN		SP2.5/4UN		SP6/10U		SP6/10U		SP6/10U		SP6/10U	
Blocchetto terminale a incastro Interlocking end clamp		CA702		CA702		CA702		CA702		CA702		CA702	
Blocchetto terminale a vite Screw end clamp		CA802		CA802		CA802		CA802		CA802		CA802	
Marcatore Marking tags		CA509/K5WHT		CA509/K6WHT		CA509/K8WHT		CA509/K8WHT		CA509/K10WHT		CA509/K10WHT	
Ponte di parallelo 2 poli Shorting links 2 poles		CA721/2 (Imax 24A)		CA722/2 (Imax 32A)		CA723/2 (Imax 41A)		CA723/2 (Imax 41A)		CA724/2 (Imax 41A)		CA724/2 (Imax 41A)	
Ponte di parallelo 3 poli Shorting links 3 poles		CA721/3 (Imax 24A)		CA722/3 (Imax 32A)		CA723/3 (Imax 41A)		CA723/3 (Imax 41A)		CA724/3 (Imax 41A)		CA724/3 (Imax 41A)	
Ponte di parallelo 4 poli Shorting links 4 poles		CA721/4 (Imax 24A)		CA722/4 (Imax 32A)		CA723/4 (Imax 41A)		CA723/4 (Imax 41A)		CA724/4 (Imax 41A)		CA724/4 (Imax 41A)	
Ponte di parallelo 10 poli Shorting links 10 poles		CA721/10 (Imax 24A)		CA722/10 (Imax 32A)		CA723/10 (Imax 41A)		CA723/10 (Imax 41A)		CA724/10 (Imax 41A)		CA724/10 (Imax 41A)	









Conformità: CE, RoHS 2015/863/EU Normative: IEC60947-7-1, UL1059, CSA22.2-158 Infiammabilità: UL94V0 Temperatura di esercizio: -40°C +80°C Resistenza al calore: 100°C	Compliance: CE, RoHS 2015/863/EU Standards: IEC60947-7-1, UL1059, CSA22.2-158 Flammability: UL94V0 Working temperature: -40°C +80°C Heat resistance: 100°C
---	---

CTS16U	CTS25UN	CTS35UN	CTS50/70N	CTS95/120N										
CTS16UBU	CTS25UNBU	CTS35UNBU	CTS50/70NBU	CTS95/120NBU										
47.8 x 43.0 x 12 mm	57.2 x 48 x 12 mm	59.2 x 50.5 x 16 mm	71.1 x 77 x 20.5 mm	83.0 x 85 x 27 mm										
1 x 2.5 ÷ 16 mm ² 2 x 2.5 ÷ 10 mm ²	1 x 4.0 ÷ 25.0 mm ² 2 x 4.0 ÷ 16.0 mm ²	1 x 4.0 ÷ 35.0 mm ² 2 x 4.0 ÷ 16.0 mm ²	1 x 10.0 ÷ 70.0 mm ² 2 x 4.0 ÷ 35.0 mm ²	1 x 25.0 ÷ 120.0 mm ² 2 x 10.0 ÷ 70.0 mm ²										
-	-	-	-	-										
1 x 0.2 ÷ 16 mm ² 2 x 0.2 ÷ 10 mm ²	1 x 4.0 ÷ 25.0 mm ² 2 x 4.0 ÷ 10.0 mm ²	1 x 4.0 ÷ 35.0 mm ² 2 x 4.0 ÷ 16.0 mm ²	1 x 10.0 ÷ 70.0 mm ²	1 x 25.0 ÷ 120.0 mm ²										
12 mm	14 mm	15 mm	22 mm	24 mm										
Poliamide 6.6 Polyamide 6.6	Poliamide 6.6 Polyamide 6.6	Poliamide 6.6 Polyamide 6.6	Poliamide 6.6 Polyamide 6.6	Poliamide 6.6 Polyamide 6.6										
IEC	UL	CSA	IEC	UL	CSA	IEC	UL	CSA	IEC	UL	CSA	IEC	UL	CSA
1000 V	600 V	600 V	1000 V	600 V	600 V	1000 V	600 V	600 V	1000 V	600 V	600 V	1000 V	600 V	600 V
76 A	85 A	70 A	101 A	105 A	85 A	125 A	150 A	130 A	192 A	175 A	175 A	269 A	240 A	240 A
1.2 Nm	14 lb-in	14 lb-in	2.0 Nm	30 lb-in	18 lb-in	2.5 Nm	30 lb-in	25 lb-in	3.0 Nm	38 lb-in	38 lb-in	6.0 Nm	90 lb-in	90 lb-in
-	-	-	-	-	-	-	-	-	-	-	-	-	-	
-	PP25UN	PP35UN	-	-	-	-	-	-	-	-	-	-	-	
SP6/10U	-	-	-	-	-	-	-	-	-	-	-	-	-	
CA702	CA702	CA702	CA702	CA202	CA202	-	-	-	-	-	-	-	-	
CA802	CA802	CA802	-	-	-	-	-	-	-	-	-	-	-	
CA509/K12WHT	CA509/K12WHT	CA509/K16WHT	CA509/K16WHT	CA509/K16WHT	CA509/K16WHT	-	-	-	-	-	-	-	-	
CA751/2 (I _{max} 65A)	CA725/2 (I _{max} 90A)	CA771/2 (I _{max} 105A)	-	-	-	-	-	-	-	-	-	-	-	
CA751/3 (I _{max} 65A)	CA725/3 (I _{max} 90A)	CA771/3 (I _{max} 105A)	-	-	-	-	-	-	-	-	-	-	-	
CA751/4 (I _{max} 65A)	CA725/4 (I _{max} 90A)	CA771/4 (I _{max} 105A)	-	-	-	-	-	-	-	-	-	-	-	
CA751/10 (I _{max} 65A)	CA725/10 (I _{max} 90A)	CA771/10 (I _{max} 105A)	-	-	-	-	-	-	-	-	-	-	-	

Morsetti di terra con serraggio a vite Ground screw clamp terminal blocks

Conformità: CE, RoHS 2015/863/EU Normative: IEC60947-7-1, UL1059, CSA22.2-158 Infiammabilità: UL94V0 Temperatura di esercizio: -40°C +80°C Resistenza al calore: 100°C			Compliance: CE, RoHS 2015/863/EU Standards: IEC60947-7-1, UL1059, CSA22.2-158 Flammability: UL94V0 Working temperature: -40°C +80°C Heat resistance: 100°C									
Immagine prodotto Product image												
Articolo Item	Giallo Yellow	Verde Green	CGT4N	CGT6N	CGT10N	CGT16N	CGT35U					
Schema di collegamento Connection diagram												
Dimensioni Dimensions	H x L x S		47.0 x 54.5 x 6 mm	48.2 x 54.5 x 8 mm	48.5 x 55.0 x 10 mm	48.5 x 55 x 12 mm	63.2 x 58 x 16 mm					
Conduttori connettibili per foro Connection Possibility each hole	Flessibili Flexible		1 x 0.2 ÷ 4.0 mm ² 2 x 0.2 ÷ 2.5 mm ²	1 x 0.2 ÷ 6.0 mm ² 2 x 0.2 ÷ 4.0 mm ²	1 x 0.2 ÷ 10.0 mm ² 2 x 0.2 ÷ 6.0 mm ²	1 x 0.2 ÷ 16.0 mm ² 2 x 0.2 ÷ 10.0 mm ²	1 x 0.2 ÷ 35.0 mm ² 2 x 0.2 ÷ 25.0 mm ²					
	Rigidi Solid		1 x 0.2 ÷ 6.0 mm ²		-		-					
	Con ferrule With ferrule/lug		1 x 0.2 ÷ 4.0 mm ² 2 x 0.2 ÷ 2.5 mm ²	1 x 0.2 ÷ 6.0 mm ² 2 x 0.2 ÷ 4.0 mm ²	1 x 0.2 ÷ 10.0 mm ² 2 x 0.2 ÷ 6.0 mm ²	1 x 0.2 ÷ 16.0 mm ² 2 x 0.2 ÷ 10.0 mm ²	1 x 0.2 ÷ 35.0 mm ²					
Lunghezza spelatura cavo Cable stripping length			8 mm	9 mm	11 mm	12 mm	15 mm					
Materiale isolante Insulating material			Poliammide 6.6 Polyamide 6.6		Poliammide 6.6 Polyamide 6.6		Poliammide 6.6 Polyamide 6.6					
Normativa di riferimento Reference standard			IEC	UL	CSA	IEC	UL	CSA				
Coppia di serraggio Tightening torque range			0.8 Nm	7 lb-in	7 lb-in	0.8 Nm	7 lb-in	7 lb-in				
Certificazioni Certifications												
Marcatore Marking tags			CA509/K5WHT		CA509/K6WHT		CA509/K8WHT		CA509/K10WHT		CA509/K16WHT	

Morsetti portafusibile con serraggio a vite Fuse screw clamp terminal blocks

Conformità: CE, RoHS 2015/863/EU Normative: IEC60947-7-1, UL1059, CSA22.2-158 Infiammabilità: UL94V0 Temperatura di esercizio: -40°C +80°C Resistenza al calore: 100°C		Compliance: CE, RoHS 2015/863/EU Standards: IEC60947-7-1, UL1059, CSA22.2-158 Flammability: UL94V0 Working temperature: -40°C +80°C Heat resistance: 100°C		
Immagine prodotto Product image				
Articolo Item	Grigio/Grey	CF4U	CF4UL6-60V	CF4UL110-240V
	Blu/Blue	CF4UBU	-	-
Schema di collegamento Connection diagram				
Dimensioni Dimensions	H x L x S	50.3 x 57.0 x 8 mm	50.3 x 57.0 x 8 mm	50.3 x 57.0 x 8 mm
Conduttori connettibili per foro Connection Possibility each hole	Flessibili Flexible	1 x 0.2 ÷ 4.0 mm ² 2 x 0.2 ÷ 2.5 mm ²	1 x 0.2 ÷ 4.0 mm ² 2 x 0.2 ÷ 2.5 mm ²	1 x 0.2 ÷ 4.0 mm ² 2 x 0.2 ÷ 2.5 mm ²
	Rigidi Solid	1 x 0.2 ÷ 6.0 mm ²	1 x 0.2 ÷ 6.0 mm ²	1 x 0.2 ÷ 6.0 mm ²
	Con terminale With ferrule/lug	1 x 0.2 ÷ 4.0 mm ² 2 x 0.2 ÷ 2.5 mm ²	1 x 0.2 ÷ 4.0 mm ² 2 x 0.2 ÷ 2.5 mm ²	1 x 0.2 ÷ 4.0 mm ² 2 x 0.2 ÷ 2.5 mm ²
Lunghezza spelatura cavo Cable stripping length		9,5 mm	9,5 mm	9,5 mm
Materiale isolante Insulating material		Poliammide 6.6 Polyamide 6.6	Poliammide 6.6 Polyamide 6.6	Poliammide 6.6 Polyamide 6.6
Normativa di riferimento Reference standard		IEC UL CSA	IEC UL CSA	IEC UL CSA
Tensione nominale Voltage Rating		800 V 600 V 600 V	800 V 600 V 600 V	800 V 600 V 600 V
Corrente nominale Current Rating		6.3 A 10 A 10 A	6.3 A 10 A 10 A	6.3 A 10 A 10 A
Coppia di serraggio Tightening torque range		0,5 Nm 7 lb-in 7 lb-in	0,5 Nm 7 lb-in 7 lb-in	0,5 Nm 7 lb-in 7 lb-in
Certificazioni Certifications				
Blocchetto terminale a incastro Interlocking end clamp		CA702	CA702	CA702
Blocchetto terminale a vite Screw end clamp		CA802	CA802	CA802
Marcatore su morsetto Marking tags on terminal		CA509/K8WHT	CA509/K8WHT	CA509/K8WHT
Marcatore su portafusibile Marking tags on fuse carrier		CA509/K6WHT	CA509/K6WHT	CA509/K6WHT

Morsetti con serraggio a vite a 2 o 3 livelli Screw clamp terminal blocks with 2 and 3 level

Conformità: CE, RoHS 2015/863/EU Normative: IEC60947-7-1, UL1059, CSA22.2-158 Infiammabilità: UL94V0 Temperatura di esercizio: -40°C +80°C Resistenza al calore: 100°C		Compliance: CE, RoHS 2015/863/EU Standards: IEC60947-7-1, UL1059, CSA22.2-158 Flammability: UL94V0 Working temperature: -40°C +80°C Heat resistance: 100°C					
Tipologia Typology		2 LIVELLI 2 LEVELS		3 LIVELLI 3 LEVELS			
Immagine prodotto Product image							
Articolo Item	Grigio/Grey	CDL4UN		CTL2.5U			
	Blu/Blue	CDL4UNBU		CTL2.5UBU			
Schema di collegamento Connection diagram							
Dimensioni Dimensions	H x L x S	59.5 x 57.5 x 6 mm		68.0 x 84.0 x 6 mm			
Conduttori connettabili per foro Connection Possibility each hole	Flessibili Flexible	1 x 0.2 ÷ 4.0 mm ² 2 x 0.2 ÷ 2.5 mm ²		1 x 0.2 ÷ 2.5 mm ² 2 x 0.2 ÷ 1.5 mm ²			
	Rigidi Solid	1 x 0.2 ÷ 6.0 mm ²		1 x 0.2 ÷ 4.0 mm ²			
	Con terminale With ferrule/lug	1 x 0.2 ÷ 4.0 mm ² 2 x 0.2 ÷ 2.5 mm ²		1 x 0.2 ÷ 2.5 mm ² 2 x 0.2 ÷ 1.5 mm ²			
Lunghezza spelatura cavo Cable stripping length		9 mm		9 mm			
Materiale isolante Insulating material		Poliammide 6.6 Polyamide 6.6		Poliammide 6.6 Polyamide 6.6			
Normativa di riferimento Reference standard		IEC	UL	CSA	IEC	UL	CSA
Tensione nominale Voltage Rating		800 V	600 V	600 V	500 V	300 V	300 V
Corrente nominale Current Rating		32 A	35 A	35 A	24 A	25 A	25 A
Coppia di serraggio Tightening torque range		0.5 Nm	7 lb-in	7 lb-in	0,4 Nm	4,5 lb-in	4,5 lb-in
Certificazioni Certifications							
Terminale End plate		EPCDL4UN		EPCTL2.5U			
Separatore Separator plate		SPCDL4U		-			
Blocchetto terminale a incastro Interlocking end clamp		CA702		CA702			
Blocchetto terminale a vite Screw end clamp		CA802		CA802			
Marcatore Marking tags		CA509/K6WHT		CA509/K2WHT			
Ponte di parallelo 2 poli Shorting links 2 poles		CA722/2 (Imax 32A)		CA722/2 (Imax 24A)			
Ponte di parallelo 3 poli Shorting links 3 poles		CA722/3 (Imax 32A)		CA722/3 (Imax 24A)			
Ponte di parallelo 4 poli Shorting links 4 poles		CA722/4 (Imax 32A)		CA722/4 (Imax 24A)			
Ponte di parallelo 10 poli Shorting links 10 poles		CA722/10 (Imax 32A)		CA722/10 (Imax 24A)			

Morsetti con serraggio a vite ad alto voltaggio High voltage screw clamp terminal blocks

Conformità: CE, RoHS 2015/863/EU Normative: IEC60947-7-1, UL1059, CSA22.2-158 Infiammabilità: UL94V0 Temperatura di esercizio: -40°C +80°C Resistenza al calore: 100°C		Compliance: CE, RoHS 2015/863/EU Standards: IEC60947-7-1, UL1059, CSA22.2-158 Flammability: UL94V0 Working temperature: -40°C +80°C Heat resistance: 100°C								
Immagine prodotto Product image										
Articolo Item	Grigio/Grey	CHV4U			CHV6U			CHV10U		
	Blu/Blue	CHV4UBU			CHV6UBU			CHV10UBU		
Schema di collegamento Connection diagram										
Dimensioni Dimensions	H x L x S	63.4 x 52.0 x 6 mm			63.4 x 52.0 x 6 mm			63.4 x 52.0 x 6 mm		
Conduttori connettibili per foro Connection Possibility each hole	Flessibili Flexible	1 x 0.2 ÷ 4.0 mm ² 2 x 0.2 ÷ 2.5 mm ²			1 x 0.2 ÷ 6.0 mm ² 2 x 0.2 ÷ 4.0 mm ²			1 x 0.2 ÷ 10.0 mm ² 2 x 0.2 ÷ 6.0 mm ²		
	Rigidi Solid	1 x 0.2 ÷ 6.0 mm ²			-			-		
	Con terminale With ferrule/lug	1 x 0.2 ÷ 4.0 mm ² 2 x 0.2 ÷ 2.5 mm ²			1 x 0.2 ÷ 6.0 mm ² 2 x 0.2 ÷ 4.0 mm ²			1 x 0.2 ÷ 10.0 mm ² 2 x 0.2 ÷ 6.0 mm ²		
Lunghezza spelatura cavo Cable stripping length		12 mm			14 mm			14 mm		
Materiale isolante Insulating material		Poliammide 6.6 Polyamide 6.6			Poliammide 6.6 Polyamide 6.6			Poliammide 6.6 Polyamide 6.6		
Normativa di riferimento Reference standard		IEC	UL	CSA	IEC	UL	CSA	IEC	UL	CSA
Tensione nominale Voltage Rating		1000 V	1000 V	1000 V	1000 V	1000 V	1000 V	1000 V	1000 V	1000 V
Corrente nominale Current Rating		32 A	35 A	35 A	41 A	50 A	50 A	57 A	65 A	65 A
Coppia di serraggio Tightening torque range		0,5 Nm	7 lb-in	7 lb-in	0,8 Nm	14 lb-in	14 lb-in	1,2 Nm	14 lb-in	14 lb-in
Certificazioni Certifications										
Terminale End plate		EPUSC			EPUSC			EPUSC		
Separatore Separator plate		SP2.5/4UN			SP2.5/4UN			SP2.5/4UN		
Blocchetto terminale a incastro Interlocking end clamp		CA702			CA702			CA702		
Blocchetto terminale a vite Screw end clamp		CA802			CA802			CA802		
Marcatore Marking tags		CA509/K5WHT			CA509/K6WHT			CA509/K8WHT		
Ponte di parallelo 2 poli Shorting links 2 poles		CA623/2 (Imax 32A)			CA624/2 (Imax 41A)			CA625/2 (Imax 57A)		
Ponte di parallelo 3 poli Shorting links 3 poles		CA623/3 (Imax 32A)			CA624/3 (Imax 41A)			CA625/3 (Imax 57A)		
Ponte di parallelo 4 poli Shorting links 4 poles		CA623/4 (Imax 32A)			CA624/4 (Imax 41A)			CA625/4 (Imax 57A)		
Ponte di parallelo 10 poli Shorting links 10 poles		CA623/10 (Imax 32A)			CA624/10 (Imax 41A)			CA625/10 (Imax 57A)		







Morsetti con serraggio a molla Spring clamp terminal blocks

Conformità: CE, RoHS 2015/863/EU Normative: IEC60947-7-1, UL1059, CSA22.2-158 Infiammabilità: UL94V0 Temperatura di esercizio: -40°C +80°C Resistenza al calore: 100°C				Compliance: CE, RoHS 2015/863/EU Standards: IEC60947-7-1, UL1059, CSA22.2-158 Flammability: UL94V0 Working temperature: -40°C +80°C Heat resistance: 100°C									
Immagine prodotto Product image													
Articolo Item	Grigio/Grey	CX2.5	CX4	CX6	CX10								
	Blu/Blue	CX2.5BU	CX4BU	CX6BU	CX10BU								
Schema di collegamento Connection diagram													
Dimensioni Dimensions	H x L x S	38.0 x 50.0 x 5 mm	38.0 x 54.8 x 6 mm	43.0 x 62.1 x 8 mm	49.5 x 71.7 x 10 mm								
Conduttori connettibili per foro Connection Possibility each hole	Flessibili Flexible	1 X 0.2 ÷ 2.5 mm ²	1 X 0.2 ÷ 4.0 mm ²	1 X 0.2 ÷ 6.0 mm ²	1 X 0.2 ÷ 10.0 mm ²								
	Rigidi Solid	1 X 0.2 ÷ 4.0 mm ²	1 X 0.2 ÷ 6.0 mm ²	-	-								
	Con terminale With ferrule/lug	1 X 0.2 ÷ 2.5 mm ²	1 X 0.2 ÷ 4.0 mm ²	1 X 0.2 ÷ 6.0 mm ²	1 X 0.2 ÷ 10.0 mm ²								
Lunghezza spelatura cavo Cable stripping length		10 mm	10 mm	14 mm	18 mm								
Materiale isolante Insulating material		Poliammide 6.6 Polyamide 6.6		Poliammide 6.6 Polyamide 6.6									
Normativa di riferimento Reference standard		IEC	UL	CSA	IEC	UL	CSA	IEC	UL	CSA	IEC	UL	CSA
Tensione nominale Voltage Rating		1000 V	600 V	600 V	1000 V	600 V	600 V	1000 V	600 V	600 V	1000 V	600 V	600 V
Corrente nominale Current Rating		24 A	20 A	20 A	32 A	30 A	30 A	41 A	50 A	50 A	57 A	65 A	65 A
Certificazioni Certifications													
Terminale End plate		EPCX2.5		EPCX4		EPCX6		EPCX6		EPCX10		EPCX10	
Diaframma Partition plate		PPCX4		PPCX4		PPCX10		PPCX10		PPCX10		PPCX10	
Blocchetto terminale a incastro Interlocking end clamp		CA702		CA702		CA702		CA702		CA702		CA702	
Blocchetto terminale a vite Screw end clamp		CA802		CA802		CA802		CA802		CA802		CA802	
Marcatore Marking tags		CA509/K5WHT		CA509/K6WHT		CA509/K8WHT		CA509/K8WHT		CA509/K10WHT		CA509/K10WHT	
Ponte di parallelo 2 poli Shorting links 2 poles		JX2.5/2 (I _{max} 24A)		JX4/2 (I _{max} 32A)		JX6/2 (I _{max} 32A)		JX6/2 (I _{max} 32A)		JX10/2 (I _{max} 57A)		JX10/2 (I _{max} 57A)	
Ponte di parallelo 3 poli Shorting links 3 poles		JX2.5/3 (I _{max} 24A)		JX4/3 (I _{max} 32A)		JX6/3 (I _{max} 32A)		JX6/3 (I _{max} 32A)		-		-	
Ponte di parallelo 4 poli Shorting links 4 poles		JX2.5/4 (I _{max} 24A)		JX4/4 (I _{max} 32A)		JX6/4 (I _{max} 32A)		JX6/4 (I _{max} 32A)		-		-	
Ponte di parallelo 8 poli Shorting links 8 poles		JX2.5/8 (I _{max} 24A)		JX4/8 (I _{max} 32A)		-		-		-		-	
Ponte di parallelo 10 poli Shorting links 10 poles		JX2.5/10 (I _{max} 24A)		JX4/10 (I _{max} 32A)		JX6/10 (I _{max} 32A)		JX6/10 (I _{max} 32A)		-		-	

Morsetti di terra con serraggio a molla Ground/Earth spring clamp terminal blocks

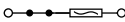
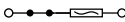
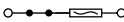
Conformità: CE, RoHS 2015/863/EU Normative: IEC60947-7-1, UL1059, CSA22.2-158 Infiammabilità: UL94V0 Temperatura di esercizio: -40°C +80°C Resistenza al calore: 100°C		Compliance: CE, RoHS 2015/863/EU Standards: IEC60947-7-1, UL1059, CSA22.2-158 Flammability: UL94V0 Working temperature: -40°C +80°C Heat resistance: 100°C											
Immagine prodotto Product image													
Articolo Item	Giallo Yellow	CXG2.5	CXG4	CXG6	CXG10								
Schema di collegamento Connection diagram													
Dimensioni Dimensions	H x L x S	38.0 x 50.0 x 5 mm	38.0 x 54.8 x 6 mm	43.0 x 62.1 x 8 mm	49.5 x 71.7 x 10 mm								
Conduttori connettibili per foro Connection Possibility each hole	Flessibili Flexible	1 X 0.2 ÷ 2.5 mm ²	1 X 0.2 ÷ 4.0 mm ²	1 X 0.2 ÷ 6.0 mm ²	1 X 0.2 ÷ 10.0 mm ²								
	Rigidi Solid	1 X 0.2 ÷ 4.0 mm ²	1 X 0.2 ÷ 6.0 mm ²	-	-								
	Con terminale With ferrule/lug	1 X 0.2 ÷ 2.5 mm ²	1 X 0.2 ÷ 4.0 mm ²	1 X 0.2 ÷ 6.0 mm ²	1 X 0.2 ÷ 10.0 mm ²								
Lunghezza spelatura cavo Cable stripping length		10 mm	10 mm	14 mm	18 mm								
Materiale isolante Insulating material		Poliammide 6.6 Polyamide 6.6		Poliammide 6.6 Polyamide 6.6									
Normativa di riferimento Reference standard		IEC	UL	CSA	IEC	UL	CSA	IEC	UL	CSA	IEC	UL	CSA
Tensione nominale Voltage Rating		1000 V	600 V	600 V	1000 V	600 V	600 V	1000 V	600 V	600 V	1000 V	600 V	600 V
Corrente nominale Current Rating		24 A	20 A	20 A	24 A	20 A	20 A	32 A	30 A	30 A	32 A	30 A	30 A
Certificazioni Certifications													
Terminale End plate		EPCX2.5		EPCX4		EPCX6		EPCX6		EPCX10		EPCX10	
Diaframma Partition plate		PPCX4		PPCX4		PPCX10		PPCX10		PPCX10		PPCX10	
Blocchetto terminale a incastro Interlocking end clamp		CA702		CA702		CA702		CA702		CA702		CA702	
Blocchetto terminale a vite Screw end clamp		CA802		CA802		CA802		CA802		CA802		CA802	
Marcatore Marking tags		CA509/K5WHT		CA509/K6WHT		CA509/K8WHT		CA509/K8WHT		CA509/K10WHT		CA509/K10WHT	
Ponte di parallelo 2 poli Shorting links 2 poles		JX2.5/2 (I _{max} 24A)		JX4/2 (I _{max} 32A)		JX6/2 (I _{max} 32A)		JX6/2 (I _{max} 32A)		JX10/2 (I _{max} 57A)		JX10/2 (I _{max} 57A)	
Ponte di parallelo 3 poli Shorting links 3 poles		JX2.5/3 (I _{max} 24A)		JX4/3 (I _{max} 32A)		JX6/3 (I _{max} 32A)		JX6/3 (I _{max} 32A)		-		-	
Ponte di parallelo 4 poli Shorting links 4 poles		JX2.5/4 (I _{max} 24A)		JX4/4 (I _{max} 32A)		JX6/4 (I _{max} 32A)		JX6/4 (I _{max} 32A)		-		-	
Ponte di parallelo 8 poli Shorting links 8 poles		JX2.5/8 (I _{max} 24A)		JX4/8 (I _{max} 32A)		-		-		-		-	
Ponte di parallelo 10 poli Shorting links 10 poles		JX2.5/10 (I _{max} 24A)		JX4/10 (I _{max} 32A)		JX6/10 (I _{max} 32A)		JX6/10 (I _{max} 32A)		-		-	

Morsetti portafusibile con serraggio a molla Fuse spring clamp terminal blocks

Conformità: CE, RoHS 2015/863/EU Normative: IEC60947-7-1, UL1059, CSA22.2-158 Infiammabilità: UL94V0 Temperatura di esercizio: -40°C +80°C Resistenza al calore: 100°C		Compliance: CE, RoHS 2015/863/EU Standards: IEC60947-7-1, UL1059, CSA22.2-158 Flammability: UL94V0 Working temperature: -40°C +80°C Heat resistance: 100°C								
Immagine prodotto Product image										
Articolo Item	Grigio/Grey	CXF4	CXF4L6-60V	CXF4L110-240V						
Schema di collegamento Connection diagram										
Dimensioni Dimensions	H x L x S	61.5 x 65.4 x 6 mm	61.5 x 65.4 x 6 mm	61.5 x 65.4 x 6 mm						
Conduttori connettibili per foro Connection Possibility each hole	Flessibili Flexible	1 X 0.2 ÷ 4.0 mm ²	1 X 0.2 ÷ 4.0 mm ²	1 X 0.2 ÷ 4.0 mm ²						
	Rigidi Solid	1 X 0.2 ÷ 6.0 mm ²	1 X 0.2 ÷ 6.0 mm ²	1 X 0.2 ÷ 6.0 mm ²						
	Con terminale With ferrule/lug	1 X 0.2 ÷ 4.0 mm ²	1 X 0.2 ÷ 4.0 mm ²	1 X 0.2 ÷ 4.0 mm ²						
Lunghezza spelatura cavo Cable stripping length		10 mm	10 mm	10 mm						
Materiale isolante Insulating material		Poliammide 6.6 Polyamide 6.6		Poliammide 6.6 Polyamide 6.6						
Normativa di riferimento Reference standard		IEC	UL	CSA	IEC	UL	CSA	IEC	UL	CSA
Tensione nominale Voltage Rating		1000 V	600 V	600 V	1000 V	600 V	600 V	1000 V	600 V	600 V
Corrente nominale Current Rating		10 A	10 A	10 A	10 A	10 A	10 A	10 A	10 A	10 A
Certificazioni Certifications										
Blocchetto terminale a incastro Interlocking end clamp		CA702			CA702			CA702		
Blocchetto terminale a vite Screw end clamp		CA802			CA802			CA802		
Marcatore Marking tags		CA509/K6WHT			CA509/K6WHT			CA509/K6WHT		
Ponte di parallelo 2 poli Shorting links 2 poles		JX4/2 (I _{max} 32A)			JX4/2 (I _{max} 32A)			JX4/2 (I _{max} 32A)		
Ponte di parallelo 3 poli Shorting links 3 poles		JX4/3 (I _{max} 32A)			JX4/3 (I _{max} 32A)			JX4/3 (I _{max} 32A)		
Ponte di parallelo 4 poli Shorting links 4 poles		JX4/4 (I _{max} 32A)			JX4/4 (I _{max} 32A)			JX4/4 (I _{max} 32A)		
Ponte di parallelo 8 poli Shorting links 8 poles		JX4/8 (I _{max} 32A)			JX4/8 (I _{max} 32A)			JX4/8 (I _{max} 32A)		
Ponte di parallelo 10 poli Shorting links 10 poles		JX4/10 (I _{max} 32A)			JX4/10 (I _{max} 32A)			JX4/10 (I _{max} 32A)		

Morsetti 2 e 3 livelli con serraggio a molla 2 and 3 level spring clamp terminal blocks

Conformità: CE, RoHS 2015/863/EU Normative: IEC60947-7-1, UL1059, CSA22.2-158 Infiammabilità: UL94V0 Temperatura di esercizio: -40°C +80°C Resistenza al calore: 100°C		Compliance: CE, RoHS 2015/863/EU Standards: IEC60947-7-1, UL1059, CSA22.2-158 Flammability: UL94V0 Working temperature: -40°C +80°C Heat resistance: 100°C					
Tipologia Tipology		2 LIVELLI 2 LEVELS		3 LIVELLI 3 LEVELS			
Immagine prodotto Product image							
Articolo Item	Grigio/Grey	CXDL2.5		CP3L2.5			
	Blu/Blue	CXDL2.5BU		-			
Schema di collegamento Connection diagram							
Dimensioni Dimensions	H x L x S	49.5 x 72.7 x 5 mm		83.1 x 98.7 x 5 mm			
Conduttori connettibili per foro Connection Possibility each hole	Flessibili Flexible	1 X 0.2 ÷ 2.5 mm ²		1 X 0.2 ÷ 2.5 mm ²			
	Rigidi Solid	1 X 0.2 ÷ 4.0 mm ²		1 X 0.2 ÷ 4.0 mm ²			
	Con terminale With ferrule/lug	1 X 0.2 ÷ 2.5 mm ²		1 X 0.2 ÷ 2.5 mm ²			
Lunghezza spelatura cavo Cable stripping length		10 mm		10 mm			
Materiale isolante Insulating material		Poliamide 6.6 Polyamide 6.6		Poliamide 6.6 Polyamide 6.6			
Normativa di riferimento Reference standard		IEC	UL	CSA	IEC	UL	CSA
Tensione nominale Voltage Rating		1000 V	600 V	600 V	500 V	300 V	-
Corrente nominale Current Rating		24 A	20 A	20 A	24 A	20 A	-
Certificazioni Certifications							
Terminale End plate		EPCXDL2.5		EPCP3L2.5			
Blocchetto terminale a incastro Interlocking end clamp		CA702		CA702			
Blocchetto terminale a vite Screw end clamp		CA802		CA802			
Marcatore Marking tags		CA509/K5WHT		CA509/K6WHT			
Ponte di parallelo 2 poli Shorting links 2 poles		JX2.5/2 (Imax 24A)		CA801/A2 (Imax 24A)			
Ponte di parallelo 3 poli Shorting links 3 poles		JX2.5/3 (Imax 24A)		CA801/A3 (Imax 24A)			
Ponte di parallelo 4 poli Shorting links 4 poles		JX2.5/4 (Imax 24A)		CA801/A4 (Imax 24A)			
Ponte di parallelo 8 poli Shorting links 8 poles		JX2.5/8 (Imax 24A)		-			
Ponte di parallelo 10 poli Shorting links 10 poles		JX2.5/10 (Imax 24A)		CA801/A10 (Imax 24A)			



Snake-Anguilla 274

Sonde passacavi e accessori
Fish tapes and accessories



Max 302

Lubrificanti per cavi
Cable lubricants



Max 303

Traccianti, sbloccanti e detergenti
Tracers, unblockers and detergents



Max 304

Gel e gomme isolanti
per connessioni elettriche
Insulating gel and rubber
for electrical connections



Nypo 318

Pressacavi in plastica e ottone
Plastic and brass cable glands



Tai

328

Fascette per cablaggio
Cable ties for wiring



Fix

331

Componenti per fissaggio di cavi e tubi
Fixing components for cables and pipes



Flex

338

Guaina spiralata in pvc e accessori
Pvc spiral sheath and accessories



Fit

339

Accessori per tubi rigidi e corrugati
Accessories for rigid and corrugated pipes



Boxy

340

Pozzetti elettrici e per irrigazione
Electric and irrigation well boxes



**Per una scelta corretta
For a correct choice**

Utilizzo sonda Fish tapes use	Caratteristiche cavidotto Cable duct features			
----------------------------------	--	--	--	--

Immagine Image	Articolo Item	Pagina Page	Diametro Diameter	Civile Domestic	Industriale Industrial	Vuoti Empty	Con cavi With cables	Diametro Diameter
	ANEF3	276	Ø3 mm	•		•		Ø16-20 mm
	ANE4	276	Ø4 mm	•		•		Ø16-25 mm
	AN4	277	Ø4 mm	•		•		Ø16-25 mm
	ANF4	277	Ø4 mm	•		•		Ø16-25 mm
	AP4	278	Ø4,2 mm	•		•	•	Ø16-32 mm
	AM5	278	Ø5 mm	•		•	•	Ø20-50 mm
	AMF3	279	Ø3,5 mm	•		•	•	Ø16-32 mm
	AM45	280	Ø4,2 mm	•		•	•	Ø16-50 mm
	AM6	282	Ø6 mm		•	•	•	Ø32-90 mm
	AI3	283	Ø3 mm	•		•	•	Ø16-50 mm
	AI6	284	Ø6 mm		•	•	•	Ø50-140 mm
	A4	285	Ø4 mm	•		•		Ø20-32 mm
	A6	286	Ø6 mm		•	•	•	Ø50-90 mm
	A10	287	Ø10 mm		•	•	•	Ø90-140 mm
	AF3	288	Ø3 mm	•		•	•	Ø16-50 mm
	AF35	290	Ø3,5 mm	•		•	•	Ø16-50 mm
	AF45	290	Ø4,5 mm		•	•	•	Ø40-90 mm
	AF6	291	Ø6 mm		•	•	•	Ø50-140 mm
	AF9	292	Ø9 mm		•	•	•	Ø63-200 mm
	AF11	293	Ø11 mm		•	•	•	Ø63-200 mm
	AFS4	299	Ø4 mm		•	•	•	Ø40-90 mm
	AFS6	300	Ø6 mm		•	•	•	Ø50-140 mm



Caratteristiche tecniche delle sonde Technical features of the fish tapes

Struttura e materiali Structure and materials			Caratteristiche Features			
Struttura Structure	Materiale Material	Rivestimento Coating	Curvatura Curvature	Forza introduzione Introduction force	Attrito Friction	Resistenza trazione Tensile strength
Lineare Linear	Nylon	-	Min 20 mm	Bassa Low	Normale Normal	100 Kg
Lineare Linear	Nylon	-	Min 40 mm	Bassa Low	Normale Normal	120 Kg
Lineare Linear	Nylon Perlon	-	Min 40 mm	Bassa Low	Normale Normal	120 Kg
Lineare Linear	Nylon Perlon	-	Min 40 mm	Bassa Low	Normale Normal	120 Kg
Spiralata Spiraled	Poliestere Polyester	-	Min 30 mm	Media Medium	Minimo Minimum	140 Kg
Spiralata Spiraled	Poliestere Polyester	-	Min 50 mm	Media Medium	Minimo Minimum	150 Kg
Spiralata Spiraled	1 filo acciaio 1 steel wire	Poliestere Polyester	Min 30 mm	Alta High	Minimo Minimum	120 Kg
Spiralata Spiraled	1 filo acciaio 1 steel wire	Poliestere Polyester	Min 40 mm	Alta High	Minimo Minimum	130 Kg
Spiralata Spiraled	1 filo acciaio 1 steel wire	Poliestere Polyester	Min 80 mm	Molto Alta Very high	Minimo Minimum	240 Kg
Spiralata Spiraled	3 fili acciaio 3 steel wires	Materiale Plastico Plastic material	Min 60 mm	Alta High	Minimo Minimum	200 Kg
Spiralata Spiraled	3 fili acciaio 3 steel wires	Materiale Plastico Plastic material	Min 120 mm	Molto Alta Very high	Minimo Minimum	1.000 Kg
Lineare Linear	Corda acciaio Steel rope	Polipropilene Polypropylene	Min 60 mm	Media Medium	Normale Normal	180 Kg
Lineare Linear	Piattina acciaio Steel strip	Polipropilene Polypropylene	Min 120 mm	Molto Alta Very high	Basso Low	320 Kg
Lineare Linear	Piattina acciaio Steel strip	Polipropilene Polypropylene	Min 250 mm	Molto Alta Very high	Basso Low	1.000 Kg
Lineare Linear	Fibra di vetro Fiberglass	Polipropilene Polypropylene	Min 60 mm	Alta High	Basso Low	80 Kg
Lineare Linear	Fibra di vetro Fiberglass	Polipropilene Polypropylene	Min 80 mm	Alta High	Basso Low	80 Kg
Lineare Linear	Fibra di vetro Fiberglass	Polipropilene Polypropylene	Min 100 mm	Molto Alta Very high	Basso Low	120 Kg
Lineare Linear	Fibra di vetro Fiberglass	Polipropilene Polypropylene	Min 150 mm	Molto Alta Very high	Basso Low	200 Kg
Lineare Linear	Fibra di vetro Fiberglass	Polipropilene Polypropylene	Min 300 mm	Molto Alta Very high	Basso Low	350 Kg
Lineare Linear	Fibra di vetro Fiberglass	Polipropilene Polypropylene	Min 400 mm	Molto Alta Very high	Basso Low	500 Kg
Spiralata Spiraled	Fibra di vetro Fiberglass	Polipropilene Polypropylene	Min 100 mm	Molto Alta Very high	Basso Low	120 Kg
Spiralata Spiraled	Fibra di vetro Fiberglass	Polipropilene Polypropylene	Min 150 mm	Molto Alta Very high	Basso Low	200 Kg



Sonde passacavi in Nylon Nylon fish tapes

Materiale: Nylon Struttura: Monofilare Rivestimento: Nessuno Diametro: Ø3 mm Teste: Fisse Conformità: CE, RoHS 2015/863/EU Material: Nylon Structure: Monofilament Coating: None Diameter: Ø3 mm Heads: Fastened Compliance: CE, RoHS 2015/863/EU						Struttura Structure		
						Ø3 mm		
						Accessori in dotazione Accessories supplied		
								
Articolo Item	Lunghezza Length	Suggerimento per un corretto utilizzo Suggestion for correct use				Forza introduzione Introduction force	Raggio di curvatura Bend radius	Resistenza trazione Tensile strength
		Uso Use	Cavidotto Cable duct	Diametro Diameter	Percorso Path			
ANEF3.005	5 m	Civile Domestic	Senza cavi Without cable	16-20 mm	Tortuoso Tortuous	Bassa Low	Min. 2 cm	100 Kg
ANEF3.010	10 m							
ANEF3.015	15 m							
ANEF3.020	20 m							

Sonde passacavi in Nylon Nylon fish tapes

Materiale: Nylon Struttura: Monofilare Rivestimento: Nessuno Diametro: Ø4 mm Teste: Intercambiabili M5 Conformità: CE, RoHS 2015/863/EU Material: Nylon Structure: Monofilament Coating: None Diameter: Ø4 mm Heads: Interchangeable M5 Compliance: CE, RoHS 2015/863/EU						Struttura Structure		
						Ø4 mm		
						Accessori in dotazione Accessories supplied		
								
Articolo Item	Lunghezza Length	Suggerimento per un corretto utilizzo Suggestion for correct use				Forza introduzione Introduction force	Raggio di curvatura Bend radius	Resistenza trazione Tensile strength
		Uso Use	Cavidotto Cable duct	Diametro Diameter	Percorso Path			
ANE4.005	5 m	Civile Domestic	Senza cavi Without cable	16-25 mm	Tortuoso Tortuous	Bassa Low	Min. 4 cm	120 Kg
ANE4.010	10 m							
ANE4.015	15 m							
ANE4.020	20 m							

Per la gamma completa di accessori di ricambio vedere pagine 296/298
For the complete range of spare accessories see pages 296/298

Sonde passacavi in Nylon Perlon Nylon Perlon fish tapes

Materiale: Nylon Perlon Struttura: Monofilare Rivestimento: Nessuno Diametro: Ø4 mm Teste: Intercambiabili M5 Conformità: CE, RoHS 2015/863/EU Material: Nylon Perlon Structure: Monofilament Coating: None Diameter: Ø4 mm Heads: Interchangeable M5 Compliance: CE, RoHS 2015/863/EU						Struttura Structure				
						Ø4 mm				
						Accessori in dotazione Accessories supplied				
Articolo Item	Lunghezza Length	Suggerimento per un corretto utilizzo Suggestion for correct use				Forza introduzione Introduction force	Raggio di curvatura Bend radius	Resistenza trazione Tensile strength		
		Uso Use	Cavidotto Cable duct	Diametro Diameter	Percorso Path					
AN4.005	5 m	Civile Domestic	Senza cavi Without cable	16-25 mm	Tortuoso Tortuous	Bassa Low	Min. 4 cm	120 Kg		
AN4.010	10 m									
AN4.015	15 m									
AN4.020	20 m									
AN4.025	25 m									
AN4.030	30 m									

Sonde passacavi in Nylon Perlon Nylon Perlon fish tapes







Materiale: Nylon Perlon Struttura: Monofilare Rivestimento: Nessuno Diametro: Ø4 mm Teste: Fisse Conformità: CE, RoHS 2015/863/EU Material: Nylon Structure: Monofilament Coating: None Diameter: Ø4 mm Heads: Fastened Compliance: CE, RoHS 2015/863/EU						Struttura Structure				
						Ø4 mm				
						Accessori in dotazione Accessories supplied				
Articolo Item	Lunghezza Length	Suggerimento per un corretto utilizzo Suggestion for correct use				Forza introduzione Introduction force	Raggio di curvatura Bend radius	Resistenza trazione Tensile strength		
		Uso Use	Cavidotto Cable duct	Diametro Diameter	Percorso Path					
ANF4.005	5 m	Civile Domestic	Senza cavi Without cable	16-25 mm	Tortuoso Tortuous	Bassa Low	Min. 4 cm	100 Kg		
ANF4.010	10 m									
ANF4.015	15 m									
ANF4.020	20 m									
ANF4.025	25 m									
ANF4.030	30 m									

Per la gamma completa di accessori di ricambio vedere pagine 296/298
For the complete range of spare accessories see pages 296/298

Sonde spiralate in Poliestere Spiral Polyester fish tapes









Materiale: Poliestere Struttura: Monofilare spiralato Rivestimento: Nessuno Diametro esterno: Ø4,2 mm Teste: Intercambiabili M5 Conformità: CE, RoHS 2015/863/EU Material: Polyester Structure: Spiral single wire Coating: None External diameter: Ø4,2 mm Heads: Interchangeable M5 Compliance: CE, RoHS 2015/863/EU				Struttura Structure				
				Ø4,2 mm				
				Accessori in dotazione Accessories supplied				
								
Articolo Item	Lunghezza Length	Suggerimento per un corretto utilizzo Suggestion for correct use				Forza introduzione Introduction force	Raggio di curvatura Bend radius	Resistenza trazione Tensile strength
		Uso Use	Cavidotto Cable duct	Diametro Diameter	Percorso Path			
AP4.010	10 m	Civile Civil	Con cavi With cables	16/32 mm	Tortuoso Tortuous	Media Medium	Min. 3 cm	120 Kg
AP4.015	15 m							
AP4.020	20 m							
AP4.025	25 m							
AP4.030	30 m							

Sonde spiralate in Poliestere Spiral Polyester fish tapes

Materiale: Poliestere Struttura: Monofilare spiralato Rivestimento: Nessuno Diametro esterno: Ø5 mm Teste: 1 fissa e 1 intercambiabile Conformità: CE, RoHS 2015/863/EU Material: Polyester Structure: Spiral single wire Coating: None External diameter: Ø5 mm Heads: 1 fixed and 1 interchangeable M5 Compliance: CE, RoHS 2015/863/EU				Struttura Structure				
				Ø5 mm				
				Accessori in dotazione Accessories supplied				
								
Articolo Item	Lunghezza Length	Suggerimento per un corretto utilizzo Suggestion for correct use				Forza introduzione Introduction force	Raggio di curvatura Bend radius	Resistenza trazione Tensile strength
		Uso Use	Cavidotto Cable duct	Diametro Diameter	Percorso Path			
AM5.010	10 m	Civile Civil	Con cavi With cables	20/50 mm	Tortuoso Tortuous	Media Medium	Min. 5 cm	140 Kg
AM5.015	15 m							
AM5.020	20 m							
AM5.030	30 m							
In caso di perdita o rottura In case of loss or breakage								
APS8.M5	Testa tirante Pulling head							
AT8.M5	Occhiello tirante Pulling eyelet							









Per la gamma completa di accessori di ricambio vedere pagine 296/298
For the complete range of spare accessories see pages 296/298

Sonde spiralate in Poliestere con anima in acciaio Spiral fish tapes of Polyester with steel core

Materiale: Poliestere Struttura: Monofilare spiralato Anima: Acciaio Diametro esterno: Ø3,5 mm Teste: Intercambiabili M4 Conformità: CE, RoHS 2015/863/EU Material: Steel Structure: Spiral single wire Core: Steel External diameter: Ø3,5 mm Heads: Interchangeable M4 Compliance: CE, RoHS 2015/863/EU				Struttura Structure				
				Ø3,5 mm				
				Accessori in dotazione Accessories supplied				
								
Articolo Item	Lunghezza Length	Suggerimento per un corretto utilizzo Suggestion for correct use				Forza introduzione Introduction force	Raggio di curvatura Bend radius	Resistenza trazione Tensile strength
		Uso Use	Cavidotto Cable duct	Diametro Diameter	Percorso Path			
AMF3.005	5 m	Civile Civil	Con cavi With cables	16/25 mm	Tortuoso Tortuous	Alta High	Min. 3 cm	120 Kg
AMF3.010	10 m							
AMF3.015	15 m							
AMF3.020	20 m							
Sonda con avvolgitore Fish tape with reel								
AMF3.015ASB	15 m	Avvolgitore Ø300 mm, in materiale plastico, con tirasonde in gomma, lunghezza massima sonde 30 metri						
AMF3.020ASB	20 m	Reel Ø300 mm, in plastic material, with rubber puller, maximum fish tape length 30 meters						
In caso di perdita o rottura In case of loss or breakage								
APT5.M4	Testa tirante Pulling head							
AT5.M4	Occhiello tirante Pulling eyelet							

Per la gamma completa di accessori di ricambio vedere pagine 296/298
For the complete range of spare accessories see pages 296/298

Sonde spiralate in Poliestere con anima in acciaio Spiral fish tapes of Polyester with steel core

Materiale: Poliestere Struttura: Monofilare spiralato Anima: Acciaio Diametro esterno: Ø4,2 mm Teste: Intercambiabili M5 Conformità: CE, RoHS 2015/863/EU Material: Polyester Structure: Spiral single wire Core: Steel External diameter: Ø4,2 mm Heads: Interchangeable M5 Compliance: CE, RoHS 2015/863/EU				Struttura Structure				
				Ø4,2 mm				
				Accessori in dotazione Accessories supplied				
								
Articolo Item	Lunghezza Length	Suggerimento per un corretto utilizzo Suggestion for correct use				Forza introduzione Introduction force	Raggio di curvatura Bend radius	Resistenza trazione Tensile strength
		Usò Use	Cavidotto Cable duct	Diametro Diameter	Percorso Path			
AM45.010	10 m	Civile Civil	Con cavi With cables	16/50 mm	Tortuoso Tortuous	Alta High	Min. 4 cm	130 Kg
AM45.015	15 m							
AM45.020	20 m							
AM45.025	25 m							
AM45.030	30 m							
Sonda con avvolgitore Fish tape with reel								
AM45.015ASB	15 m	Avvolgitore Ø300 mm, in materiale plastico, con tirasonde in gomma, lunghezza massima sonde 30 metri Reel Ø300 mm, in plastic material, with rubber puller, maximum fish tape length 30 meters						
AM45.020ASB	20 m							
AM45.030ASB	30 m							
In caso di perdita o rottura In case of loss or breakage								
APT6.M5	Testa tirante Pulling head							
AT6.M5	Occhiello tirante Pulling eyelet							

Per la gamma completa di accessori di ricambio vedere pagine 296/298
For the complete range of spare accessories see pages 296/298

Sonde spiralate in Poliestere con anima in acciaio Spiral fish tapes of Polyester with steel core

Materiale: Poliestere Struttura: Monofilare spiralato Anima: Acciaio Diametro esterno: Ø6 mm Teste: Intercambiabili M5 Conformità: CE, RoHS 2015/863/EU Material: Polyester Structure: Spiral single wire Core: Steel External diameter: Ø6 mm Heads: Interchangeable M5 Compliance: CE, RoHS 2015/863/EU			Struttura Structure		
			Ø6 mm		
	Accessori in dotazione Accessories supplied				









Articolo Item	Lunghezza Length	Suggerimento per un corretto utilizzo Suggestion for correct use				Forza introduzione Introduction force	Raggio di curvatura Bend radius	Resistenza trazione Tensile strength
		Uso Use	Cavidotto Cable duct	Diametro Diameter	Percorso Path			
AM6.010	10 m	Civile Civil	Con cavi With cables	32/90 mm	Tortuoso Tortuous	Molto alta Very high	Min. 8 cm	240 Kg
AM6.015	15 m							
AM6.020	20 m							
AM6.025	25 m							
AM6.030	30 m							
AM6.040	40 m							
AM6.050	50 m							
AM6.060	60 m							

Sonda con avvolgitore verticale Fish tape with vertical reel			
AM6.030C350	30 m	Avvolgitore Ø 350 mm, per uso verticale o in orizzontale in acciaio verniciato, con freno di sicurezza Reel Ø 350 mm, for vertical and in horizontal use in painted steel, with safety brake	
AM6.040C350	40 m		
AM6.050C350	50 m		
AM6.060C350	60 m		

In caso di perdita o rottura In case of loss or breakage			
APT8.M5	Testa tirante Pulling head		
AT8.M5	Occhiello tirante Pulling eyelet		

Per la gamma completa di accessori di ricambio vedere pagine 296/298
For the complete range of spare accessories see pages 296/298

Sonde spiralate in acciaio INOX rivestite in materiale plastico Spiral fish tapes stainless steel covered with insulating material

Materiale: 3 fili acciaio Struttura: Trifilare spiralato Rivestimento: Materiale plastico Diametro esterno: Ø3 mm Teste: Intercambiabili M4 Conformità: CE, RoHS 2015/863/EU Material: 3 steel wires Structure: Spiral three wires Coating: Plastic material External diameter: Ø3 mm Heads: Interchangeable M4 Compliance: CE, RoHS 2015/863/EU				Struttura Structure				
				Ø3 mm				
				Accessori in dotazione Accessories supplied				
								
Articolo Item	Lunghezza Length	Suggerimento per un corretto utilizzo Suggestion for correct use				Forza introduzione Introduction force	Raggio di curvatura Bend radius	Resistenza trazione Tensile strength
		Uso Use	Cavidotto Cable duct	Diametro Diameter	Percorso Path			
AI3.010	10 m	Civile Civil	Con cavi With cables	16/50 mm	Tortuoso Tortuous	Alta High	Min. 6 cm	200 Kg
AI3.015	15 m							
AI3.020	20 m							
AI3.025	25 m							
AI3.030	30 m							
Sonda con avvolgitore Fish tape with reel								
AI3.015ASB	15 m	Avvolgitore Ø300 mm, in materiale plastico, con tirasonde in gomma, lunghezza massima sonde 30 metri Reel Ø300 mm, in plastic material, with rubber puller, maximum fish tape length 30 meters						
AI3.020ASB	20 m							
AI3.030ASB	30 m							
In caso di perdita o rottura In case of loss or breakage								
APS5.M4	Testa tirante Pulling head							
AT5.M4	Occhiello tirante Pulling eyelet							

Per la gamma completa di accessori di ricambio vedere pagine 296/298
For the complete range of spare accessories see pages 296/298

Sonde spiralate in acciaio INOX rivestite in materiale plastico Spiral fish tapes stainless steel covered with insulating material



Materiale: 3 fili acciaio Struttura: Trifilare spiralato Rivestimento: Materiale plastico Diametro esterno: Ø6 mm Teste: Intercambiabili M5 Conformità: CE, RoHS 2015/863/EU Material: 3 steel wires Structure: Spiral three wires Coating: Plastic material External diameter: Ø6 mm Heads: Interchangeable M5 Compliance: CE, RoHS 2015/863/EU						Struttura Structure		
						Ø6 mm		
						Accessori in dotazione Accessories supplied		
Articolo Item	Lunghezza Length	Suggerimento per un corretto utilizzo Suggestion for correct use				Forza introduzione Introduction force	Raggio di curvatura Bend radius	Resistenza trazione Tensile strength
		Uso Use	Cavidotto Cable duct	Diametro Diameter	Percorso Path			
AI6.015	15 m	Industriale Industrial	Con cavi With cables	50/140 mm	Tortuoso Tortuous	Molto alta Very high	Min. 12 cm	1.000 Kg
AI6.020	20 m							
AI6.030	30 m							
AI6.040	40 m							
AI6.050	50 m							
AI6.060	60 m							
Sonda con avvolgitore verticale Fish tape with vertical reel								
AI6.020CA	20 m	Avvolgitore Ø 600 mm, per uso verticale o in orizzontale in acciaio verniciato, con freno di sicurezza Reel Ø 600 mm, for vertical and in horizontal use in painted steel, with safety brake						
AI6.030CA	30 m							
AI6.040CA	40 m							
AI6.050CA	50 m							
AI6.060CA	60 m							
In caso di perdita o rottura In case of loss or breakage								
APS8.M5	Testa tirante Pulling head							
AT8.M5	Occhiello tirante Pulling eyelet							

Per la gamma completa di accessori di ricambio vedere pagine 296/298
For the complete range of spare accessories see pages 296/298









Sonde in corda di acciaio rivestite Polipropilene Fish tapes in steel rope coated with Polypropylene



Materiale: Acciaio Struttura: Corda Rivestimento: Polipropilene Diametro esterno: Ø4 mm Teste: Intercambiabili M5 Conformità: CE, RoHS 2015/863/EU Material: Steel Structure: Rope Coating: Polypropylene External diameter: Ø4 mm Heads: Interchangeable M5 Compliance: CE, RoHS 2015/863/EU						Struttura Structure		
						Ø4 mm		
						Accessori in dotazione Accessories supplied		
Articolo Item	Lunghezza Length	Suggerimento per un corretto utilizzo Suggestion for correct use				Forza introduzione Introduction force	Raggio di curvatura Bend radius	Resistenza trazione Tensile strength
		Uso Use	Cavidotto Cable duct	Diametro Diameter	Percorso Path			
A4.010	10 m	Civile Civil	Con cavi With cables	20/32 mm	Tortuoso Tortuous	Media Medium	Min. 6 cm	200 Kg
A4.015	15 m							
A4.020	20 m							
A4.030	30 m							
In caso di perdita o rottura In case of loss or breakage								
APT6.M5	Testa tirante Pulling head							
AT6.M5	Occhiello tirante Pulling eyelet							

Per la gamma completa di accessori di ricambio vedere pagine 296/298
For the complete range of spare accessories see pages 296/298

Sonde in corda di acciaio rivestite in Nylon Fish tapes in steel rope coated with Nylon

Materiale: Acciaio Struttura: Corda Rivestimento: Nylon Diametro esterno: Ø4 mm Teste: 1 fissa e 1 intercambiabile M5 Conformità: CE, RoHS 2015/863/EU Material: Steel Structure: Rope Coating: Nylon External diameter: Ø4 mm Heads: 1 fixed and 1 interchangeable M5 Compliance: CE, RoHS 2015/863/EU						Struttura Structure		
		Ø4 mm						
		Accessori in dotazione Accessories supplied						
Articolo Item	Lunghezza Length	Suggerimento per un corretto utilizzo Suggestion for correct use				Forza introduzione Introduction force	Raggio di curvatura Bend radius	Resistenza trazione Tensile strength
		Uso Use	Cavidotto Cable duct	Diametro Diameter	Percorso Path			
A4.014MAX	14 m	Civile Civil	Con cavi With cables	20/32 mm	Tortuoso Tortuous	Media Medium	Min. 6 cm	180 Kg
A4.021MAX	21 m							
Sonda con avvolgitore Fish tape with reel								
A4.014ASB	14 m	Avvolgitore Ø300 mm, in materiale plastico, con tirasonde in gomma, lunghezza massima sonde 30 metri						
A4.021ASB	21 m	Reel Ø300 mm, in plastic material, with rubber puller, maximum fish tape length 30 meters						
In caso di perdita o rottura In case of loss or breakage								
APS6.M5	Testa tirante Pulling head							
AT6.M5	Occhiello tirante Pulling eyelet							

Per la gamma completa di accessori di ricambio vedere pagine 296/298
For the complete range of spare accessories see pages 296/298



Sonde in piattina di acciaio rivestite Polipropilene Flat steel fish tapes coated in Polypropylene

Materiale: Acciaio Struttura: Piattina di acciaio Rivestimento: Polipropilene Diametro esterno: Ø6 mm Teste: Intercambiabili M5 Conformità: CE, RoHS 2015/863/EU Material: Steel Structure: Steel strip Coating: Polypropylene External diameter: Ø6 mm Heads: Interchangeable M5 Compliance: CE, RoHS 2015/863/EU		Struttura Structure	
		Ø6 mm	
		Accessori in dotazione Accessories supplied	
			

Articolo Item	Lunghezza Length	Suggerimento per un corretto utilizzo Suggestion for correct use				Forza introduzione Introduction force	Raggio di curvatura Bend radius	Resistenza trazione Tensile strength
		Uso Use	Cavidotto Cable duct	Diametro Diameter	Percorso Path			
A6.010	10 m	Industriale Industrial	Con cavi With cables	50/90 mm	Tortuoso Tortuous	Molto alta Very high	Min. 12 cm	320 Kg
A6.020	20 m							
A6.030	30 m							
A6.040	40 m							
A6.050	50 m							
A6.060	60 m							
A6.080	80 m							
A6.100	100 m							









Sonda con avvolgitore orizzontale Fish tape with horizontal reel		
A6.040C450	40 m	Avvolgitore Ø 450 mm per uso orizzontale, in acciaio verniciato, con freno di sicurezza
A6.050C450	50 m	Reel Ø 450 mm, for horizontal use of painted steel, with safety brake

Sonda con avvolgitore verticale Fish tape with vertical reel		
A6.040C550	40 m	Avvolgitore Ø 600 mm per uso verticale o orizzontale, in acciaio verniciato, con freno di sicurezza Reel Ø 600 mm, for vertical and horizontal use of painted steel, with safety brake
A6.050C550	50 m	
A6.060C550	60 m	
A6.080C550	80 m	
A6.100C550	100 m	

In caso di perdita o rottura In case of loss or breakage		
APT8.M5	Testa flessibile Flexible head	
AT8.M5	Occhiello tirante Pulling eyelet	
AR30.M5	Testa a carrucola Rolling head	









Per la gamma completa di accessori di ricambio vedere pagine 296/298
For the complete range of spare accessories see pages 296/298

Sonde in piattina di acciaio rivestite Polipropilene Flat steel fish tapes coated in Polypropylene

Materiale: Acciaio Struttura: Piattina di acciaio Rivestimento: Polipropilene Diametro esterno: Ø10 mm Teste: Intercambiabili M12 Conformità: CE, RoHS 2015/863/EU Material: Steel Structure: Steel Strip Coating: Polypropylene External diameter: Ø10 mm Heads: Interchangeable M12 Compliance: CE, RoHS 2015/863/EU				Struttura Structure				
				Ø10 mm				
				Accessori in dotazione Accessories supplied				
								
Articolo Item	Lunghezza Length	Suggerimento per un corretto utilizzo Suggestion for correct use				Forza introduzione Introduction force	Raggio di curvatura Bend radius	Resistenza trazione Tensile strength
		Uso Use	Cavidotto Cable duct	Diametro Diameter	Percorso Path			
A10.040	40 m	Industriale Industrial	Con cavi With cables	Ø90-140 mm	Tortuoso Tortuous	Molto alta Very high	Min. 25 cm	1.000 Kg
A10.050	50 m							
A10.060	60 m							
A10.080	80 m							
A10.100	100 m							
Sonda con avvolgitore orizzontale Fish tape with horizontal reel								
A10.040C720	40 m	Avvolgitore Ø 720 mm per uso orizzontale, in acciaio verniciato, con freno di sicurezza Reel Ø 720 mm, for horizontal use of painted steel, with safety brake						
A10.050C720	50 m							
A10.060C720	60 m							
Sonda con avvolgitore verticale Fish tape with vertical reel								
A10.080C850	80 m	Avvolgitore Ø 800 mm per uso verticale o orizzontale, in acciaio verniciato, con freno di sicurezza Reel Ø 800 mm, for vertical and horizontal use of painted steel, with safety brake						
A10.100C850	100 m							
A10.150C850	150 m							
In caso di perdita o rottura In case of loss or breakage								
AP14.M12	Testa flessibile Flexible head							
AR30.M12	Testa a carrucola Rolling head							













Per la gamma completa di accessori di ricambio vedere pagine 296/298
For the complete range of spare accessories see pages 296/298

Sonde in fibra di vetro rivestite Polipropilene Polypropylene coated fiberglass fish tapes

Materiale: Fibra di vetro Struttura: Lineare Rivestimento: Polipropilene Diametro esterno: Ø3 mm Teste: Intercambiabili M5 Conformità: CE, RoHS 2015/863/EU Material: Fiberglass Structure: Linear Coating: Polypropylene External diameter: Ø3 mm Heads: Interchangeable M5 Compliance: CE, RoHS 2015/863/EU				Struttura Structure				
				Ø3 mm				
				Accessori in dotazione Accessories supplied				
								
Articolo Item	Lunghezza Length	Suggerimento per un corretto utilizzo Suggestion for correct use				Forza introduzione Introduction force	Raggio di curvatura Bend radius	Resistenza trazione Tensile strength
		Uso Use	Cavidotto Cable duct	Diametro Diameter	Percorso Path			
AF3.015	15 m	Civile Civil	Con cavi With cables	16/50 mm	Lineare Linear	Alta High	Min. 6 cm	80 Kg
AF3.020	20 m							
AF3.030	30 m							
Sonda con avvolgitore Fish tape with reel								
AF3.015ASB	15 m	Avvolgitore Ø300 mm, in materiale plastico, con tirasonde in gomma, lunghezza massima sonde 30 metri Reel Ø300 mm, in plastic material, with rubber puller, maximum fish tape length 30 meters						
AF3.020ASB	20 m							
AF3.030ASB	30 m							
In caso di perdita o rottura In case of loss or breakage								
APT6.M5	Testa flessibile Flexible head							
AT6.M5	Occhiello tirante Pulling eyelet							

Per la gamma completa di accessori di ricambio vedere pagine 296/298
For the complete range of spare accessories see pages 296/298

Sonde in fibra di vetro rivestite Nylon Nylon coated fiberglass fish tapes







Materiale: Fibra di vetro Struttura: Lineare Rivestimento: Nylon Diametro esterno: Ø3 mm Teste: Intercambiabili M5 Conformità: CE, RoHS 2015/863/EU Material: Fiberglass Structure: Linear Coating: Nylon External diameter: Ø3 mm Heads: Interchangeable M5 Compliance: CE, RoHS 2015/863/EU						Struttura Structure		
						Ø3 mm		
						Accessori in dotazione Accessories supplied		
								
Articolo Item	Lunghezza Length	Suggerimento per un corretto utilizzo Suggestion for correct use				Forza introduzione Introduction force	Raggio di curvatura Bend radius	Resistenza trazione Tensile strength
		Uso Use	Cavidotto Cable duct	Diametro Diameter	Percorso Path			
AF3.014MAX	14 m	Civile Civil	Con cavi With cables	16/50 mm	Lineare Linear	Alta High	Min. 6 cm	80 Kg
AF3.021MAX	21 m							
In caso di perdita o rottura In case of loss or breakage								
APT6.M5	Testa flessibile con occhiello Flexible head with eyelet							
AP6.M5	Testa flessibile Flexible head							
AGFM5.M5	Giunto di collegamento Coupling joint							
ARM045	Teste da crimpare Heads to be crimped							
AT6.M5	Occhiello tirante Pulling eyelet							

Per la gamma completa di accessori di ricambio vedere pagine 296/298
For the complete range of spare accessories see pages 296/298

Sonde in fibra di vetro rivestite Polipropilene Polypropylene coated fiberglass fish tapes

Materiale: Fibra di vetro Struttura: Lineare Rivestimento: Polipropilene Diametro esterno: Ø3,5 mm Teste: Intercambiabili M5 Conformità: CE, RoHS 2015/863/EU Material: Fiberglass Structure: Linear Coating: Polypropylene External diameter: Ø3,5 mm Heads: Interchangeable M5 Compliance: CE, RoHS 2015/863/EU						Struttura Structure		
						Ø3,5 mm		
						Accessori in dotazione Accessories supplied		
								
Articolo Item	Lunghezza Length	Suggerimento per un corretto utilizzo Suggestion for correct use				Forza introduzione Introduction force	Raggio di curvatura Bend radius	Resistenza trazione Tensile strength
		Uso Use	Cavidotto Cable duct	Diametro Diameter	Percorso Path			
AF35.010	10 m	Civile Civil	Con cavi With cables	16/50 mm	Lineare Linear	Alta High	Min. 8 cm	80 Kg
AF35.015	15 m							
AF35.020	20 m							
AF35.025	25 m							

Sonde in fibra di vetro rivestite polipropilene Polypropylene coated fiberglass fish tapes

Materiale: Fibra di vetro Struttura: Lineare Rivestimento: Polipropilene Diametro esterno: Ø4,5 mm Teste: Intercambiabili M5 Conformità: CE, RoHS 2015/863/EU Material: Fiberglass Structure: Linear Coating: Polypropylene External diameter: Ø4,5 mm Heads: Interchangeable M5 Compliance: CE, RoHS 2015/863/EU						Struttura Structure		
						Ø4,5 mm		
						Accessori in dotazione Accessories supplied		
								
Articolo Item	Lunghezza Length	Suggerimento per un corretto utilizzo Suggestion for correct use				Forza introduzione Introduction force	Raggio di curvatura Bend radius	Resistenza trazione Tensile strength
		Uso Use	Cavidotto Cable duct	Diametro Diameter	Percorso Path			
AF45.015	15 m	Civile Civil	Con cavi With cables	40/90 mm	Lineare Linear	Alta High	Min. 10 cm	120 Kg
AF45.030	30 m							
In caso di perdita o rottura In case of loss or breakage								
APT6.M5	Testa flessibile Flexible head							
AT6.M5	Occhiello tirante Pulling eyelet							







Per la gamma completa di accessori di ricambio vedere pagine 296/298
For the complete range of spare accessories see pages 296/298

Sonde in fibra di vetro rivestite Polipropilene Polypropylene coated fiberglass fish tapes

Materiale: Fibra di vetro Struttura: Lineare Rivestimento: Polipropilene Diametro esterno: Ø6 mm Teste: Intercambiabili M5 Conformità: CE, RoHS 2015/863/EU Material: Fiberglass Structure: Linear Coating: Polypropylene External diameter: Ø6 mm Heads: Interchangeable M5 Compliance: CE, RoHS 2015/863/EU		Struttura Structure	
		Ø6 mm	
		Accessori in dotazione Accessories supplied	
			









Articolo Item	Lunghezza Length	Suggerimento per un corretto utilizzo Suggestion for correct use				Forza introduzione Introduction force	Raggio di curvatura Bend radius	Resistenza trazione Tensile strength
		Uso Use	Cavidotto Cable duct	Diametro Diameter	Percorso Path			
AF6.030	30 m	Industriale Industrial	Con cavi With cables	Ø50/140 mm	Lineare Linear	Molto alta Very high	Min. 15 cm	200 Kg
AF6.040	40 m							
AF6.050	50 m							
AF6.060	60 m							
AF6.080	80 m							
AF6.100	100 m							

Sonda con avvolgitore verticale Fish tape with vertical reel			
AF6.040C550	40 m	Avvolgitore Ø 600 mm per uso verticale o orizzontale, in acciaio verniciato, con freno di sicurezza Reel Ø 600 mm, for vertical and horizontal use of painted steel, with safety brake	
AF6.050C550	50 m		
AF6.060C550	60 m		
AF6.080C550	80 m		
AF6.100C550	100 m		

In caso di perdita o rottura In case of loss or breakage			
AP8.M5	Testa flessibile Flexible head		
AT8.M5	Occhiello tirante Pulling eyelet		
AR30.M5	Testa a carrucola Rolling head		

Per la gamma completa di accessori di ricambio vedere pagine 296/298
For the complete range of spare accessories see pages 296/298

Sonde in fibra di vetro rivestite polipropilene Polypropylene coated fiberglass fish tapes

Materiale: Fibra di vetro Struttura: Lineare Rivestimento: Polipropilene Diametro esterno: Ø9 mm Teste: Intercambiabili M12 Conformità: CE, RoHS 2015/863/EU Material: Fiberglass Structure: Linear Coating: Polypropylene External diameter: Ø9 mm Heads: Interchangeable M12 Compliance: CE, RoHS 2015/863/EU				Struttura Structure				
				Ø9 mm				
				Accessori in dotazione Accessories supplied				
								
Articolo Item	Lunghezza Length	Suggerimento per un corretto utilizzo Suggestion for correct use				Forza introduzione Introduction force	Raggio di curvatura Bend radius	Resistenza trazione Tensile strength
		Uso Use	Cavidotto Cable duct	Diametro Diameter	Percorso Path			
AF9.050	50 m	Industriale Industrial	Con cavi With cables	Ø63/200 mm	Lineare Linear	Molto alta Very high	Min. 30 cm	350 Kg
AF9.060	60 m							
AF9.080	80 m							
AF9.100	100 m							
AF9.150	150 m							
Sonda con avvolgitore orizzontale Fish tape with horizontal reel								
AF9.050C720	50 m	Avvolgitore Ø 720 mm per uso orizzontale, in acciaio verniciato, con freno di sicurezza Reel Ø 720 mm, for horizontal use of painted steel, with safety brake						
AF9.060C720	60 m							
AF9.080C720	80 m							
Sonda con avvolgitore verticale Fish tape with vertical reel								
AF9.040C700	40 m	Avvolgitore Ø 800 mm per uso verticale o orizzontale, in acciaio verniciato, con freno di sicurezza Reel Ø 800 mm, for vertical and horizontal use of painted steel, with safety brake						
AF9.050C700	50 m							
AF9.060C700	60 m							
AF9.080C700	80 m							
AF9.100C850	100 m							
AF9.150C850	150 m							
In caso di perdita o rottura In case of loss or breakage								
AP14.M12	Testa flessibile Flexible head							
AR30.M12	Testa a carrucola Rolling head							

Per la gamma completa di accessori di ricambio vedere pagine 296/298
For the complete range of spare accessories see pages 296/298

Sonde in fibra di vetro rivestite polipropilene Polypropylene coated fiberglass fish tapes

Materiale: Fibra di vetro Struttura: Lineare Rivestimento: Polipropilene Diametro esterno: Ø11 mm Teste: Intercambiabili M12 Conformità: CE, RoHS 2015/863/EU Material: Fiberglass Structure: Linear Coating: Polypropylene External diameter: Ø11 mm Heads: Interchangeable M12 Compliance: CE, RoHS 2015/863/EU		Struttura Structure	
		Ø11 mm	
		Accessori in dotazione Accessories supplied	
			

Articolo Item	Lunghezza Length	Suggerimento per un corretto utilizzo Suggestion for correct use				Forza introduzione Introduction force	Raggio di curvatura Bend radius	Resistenza trazione Tensile strength
		Uso Use	Cavidotto Cable duct	Diametro Diameter	Percorso Path			
AF11.080	80 m	Industriale Industrial	Con cavi With cables	Ø63/140 mm	Lineare Linear	Molto alta Very high	Min. 40 cm	500 Kg
AF11.100	100 m							
AF11.150	150 m							
AF11.200	200 m							
AF11.250	250 m							
AF11.300	300 m							

Sonda con avvolgitore verticale Fish tape with vertical reel			
AF11.080C850	80 m	Avvolgitore Ø 800 mm per uso verticale o orizzontale, in acciaio verniciato, con freno di sicurezza	
AF11.100C850	100 m	Reel Ø 800 mm, for vertical and horizontal use of painted steel, with safety brake	
AF11.150C1000	150 m	Avvolgitore Ø 1.000 mm per uso verticale o orizzontale, in acciaio verniciato, con freno di sicurezza	
AF11.200C1000	200 m		
AF11.250C1100	250 m		
AF11.300C1100	300 m		

In caso di perdita o rottura In case of loss or breakage			
AP14.M12	Testa flessibile Flexible head		
AR30.M12	Testa a carrucola Rolling head		

Sonde spiralate in fibra di vetro rivestite in materiale plastico Spiraled fiberglass fish tapes coated with plastic material



Materiale: Fibra di vetro Struttura: Monofilare spiralata Rivestimento: materiale plastico Diametro esterno: Ø4 mm Teste: Intercambiabili M5 Conformità: CE, RoHS 2015/863/EU Material: Fiberglass Structure: Monofilament spiral Coating: plastic material External diameter: Ø4 mm Heads: Interchangeable M5 Compliance: CE, RoHS 2015/863/EU				Struttura Structure				
				Ø4 mm				
				Accessori in dotazione Accessories supplied				
Articolo Item	Lunghezza Length	Suggerimento per un corretto utilizzo Suggestion for correct use				Forza introduzione Introduction force	Raggio di curvatura Bend radius	Resistenza trazione Tensile strength
		Uso Use	Cavidotto Cable duct	Diametro Diameter	Percorso Path			
AFS4.010	10 m	Industriale Industrial	Con cavi With cables	Ø40/90 mm	Lineare Linear	Alta High	Min. 10 cm	120 Kg
AFS4.015	15 m							
AFS4.020	20 m							
AFS4.030	30 m							
Sonda con avvolgitore Fish tape with reel								
AFS4.015ASB	15 m	Avvolgitore Ø300 mm, in materiale plastico, con tirasonde in gomma, lunghezza massima sonde 30 metri Reel Ø300 mm, in plastic material, with rubber puller, maximum fish tape length 30 meters						
AFS4.020ASB	20 m							
AFS4.030ASB	30 m							
In caso di perdita o rottura In case of loss or breakage								
APT6.M5	Testa flessibile Flexible head							
AT6.M5	Occhiello tirante Pulling eyelet							

Per la gamma completa di accessori di ricambio vedere pagine 296/298
For the complete range of spare accessories see pages 296/298

Sonde spiralate in fibra di vetro rivestite in materiale plastico Spiraled fiberglass fish tapes coated with plastic material



Materiale: Fibra di vetro Struttura: Monofilare spiralata Rivestimento: materiale plastico Diametro esterno: Ø6 mm Teste: Intercambiabili M5 Conformità: CE, RoHS 2015/863/EU Material: Fiberglass Structure: Monofilament spiral Coating: plastic material External diameter: Ø6 mm Heads: Interchangeable M5 Compliance: CE, RoHS 2015/863/EU		Struttura Structure	
		Ø6 mm	
		Accessori in dotazione Accessories supplied	

Articolo Item	Lunghezza Length	Suggerimento per un corretto utilizzo Suggestion for correct use				Forza introduzione Introduction force	Raggio di curvatura Bend radius	Resistenza trazione Tensile strength
		Uso Use	Cavidotto Cable duct	Diametro Diameter	Percorso Path			
AFS6.015	15 m	Industriale Industrial	Con cavi With cables	Ø50/140 mm	Lineare Linear	Alta High	Min. 15 cm	200 Kg
AFS6.020	20 m							
AFS6.030	30 m							
AFS6.040	40 m							
AFS6.050	50 m							
AFS6.060	60 m							

Sonda con avvolgitore verticale Fish tape with vertical reel			
AFS6.030CA	30 m	Avvolgitore Ø 600 mm per uso verticale o orizzontale, in acciaio verniciato, con freno di sicurezza Reel Ø 600 mm, for vertical and horizontal use of painted steel, with safety brake	
AFS6.040CA	40 m		
AFS6.050CA	50 m		
AFS6.060CA	60 m		

In caso di perdita o rottura In case of loss or breakage			
AP8.M5	Testa flessibile Flexible head		
AT8.M5	Occhiello tirante Pulling eyelet		
AR30.M5	Testa a carrucola Rolling head		

Per la gamma completa di accessori di ricambio vedere pagine 296/298
For the complete range of spare accessories see pages 296/298

Teste flessibili con occhiello





Flexible heads with eyelet

Articolo Item	Materiale fusto Barrel material	Per sonde diametro For diameter fish tape	Diametro testa Head diameter	Filettatura Threaded	Immagine Image
APT5.M4	Acciaio elicoidale Helical steel	Ø 3 mm	Ø 5 mm	M4	
APT6.M5		Ø 3/4,5 mm	Ø 6 mm	M5	
APT8.M5		Ø 5/6 mm	Ø 8 mm	M5	
APS5.M4	Corda di acciaio Steel rope	Ø 3 mm	Ø 5 mm	M4	
APS6.M5		Ø 3/4,5 mm	Ø 6 mm	M5	
APS8.M5		Ø 5/6 mm	Ø 8 mm	M5	

Per KIT con teste flessibili + occhielli tiranti vedere listino figurato in vigore
For KIT with flexible heads + pulling eyelets see current price list

Teste flessibili

Flexible heads

Articolo Item	Materiale fusto Barrel material	Per sonde diametro For diameter fish tape	Diametro testa Head diameter	Filettatura Threaded	Immagine Image
AP6.M5	Acciaio elicoidale Helical steel	Ø 3/4,5 mm	Ø 6 mm	M5	
AP8.M5		Ø 5/6 mm	Ø 8 mm	M5	
AP10.M5		Ø 3/4,5 mm	Ø 10 mm	M5	
AP13.M5		Ø 3/4,5 mm	Ø 13 mm	M5	
AP14.M12		Ø 9/11 mm	Ø 14 mm	M12	

Teste flessibili con rotella

Flexible heads with wheel

Articolo Item	Materiale fusto Barrel material	Per sonde diametro For diameter fish tape	Diametro testa Head diameter	Filettatura Threaded	Immagine Image
APR7.M5	Acciaio elicoidale Helical steel	Ø 3/4,5 mm	Ø 7 mm	M5	
APR9.M5		Ø 5/6 mm	Ø 9 mm	M5	

Tirasonde in gomma

Rubber fish tape puller

Articolo Item	Materiale Material	Per sonde diametro For diameter fish tape	Immagine Image
ATG06	Gomma Rubber	Da Ø 3 a 6 mm From Ø 3 to 6 mm	

Teste di ricambio da crimpare Replacement heads to crimp

Articolo Item	Materiale Material	Modelli sonda Fish tape models	Per sonde diametro For diameter fish tape	Filettatura Threaded	Immagine Image
ARM030	Ottone Brass	AMF3	Ø 3 mm	M4	
ARM045		AM45	Ø 4,2 mm	M5	
ARM060		AM6	Ø 6 mm	M5	
ARI030		AI3	Ø 3 mm	M4	
ARI060		AI6	Ø 6 mm	M5	

Occhiello tirante Pulling eyelet

Articolo Item	Materiale Material	Per sonde diametro For diameter fish tape	Diametro testa Head diameter	Filettatura Threaded	Immagine Image
AT5.M4	Ottone Brass	Ø 3 mm	Ø 5 mm	M4	
AT6.M5		Ø 3/4,5 mm	Ø 6 mm	M5	
AT8.M5		Ø 5/6 mm	Ø 8 mm	M5	
AT10.M5		Ø 3/6 mm	Ø 10 mm	M5	

Teste con rotella Rolling heads

Articolo Item	Materiale Material	Per sonde diametro For diameter fish tape	Diametro testa Head diameter	Filettatura Threaded	Immagine Image
AR30.M5	Alluminio Aluminium	Ø 5/6 mm	Ø 30 mm	M5	
AR30.M12		Ø 9/11 mm	Ø 30 mm	M12	
AR53.M12		Ø 9/11 mm	Ø 53 mm	M12	



Giunti di collegamento Coupling joints

Articolo Item	Materiale Material	Per sonde diametro For diameter fish tape	Diametro testa Head diameter	Filettatura Threaded	Immagine Image
AGFM5.M5	Ottone Brass	Ø 3/4,5 mm	Ø 6 mm	M5	
AGM5.M5	Alluminio Aluminium	Ø 4/6 mm	Ø 12 mm	M5	
AGM12.M12		Ø 9/11 mm	Ø 25 mm	M12	

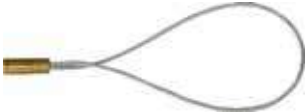

Grillo tirante Tie shackle

Articolo Item	Materiale Material	Per sonde diametro For diameter fish tape	Diametro testa Head diameter	Filettatura Threaded	Immagine Image
AGT30.M5	Alluminio Aluminium	Ø 5/6 mm	Ø 30 mm	M5	
AGT30.M12		Ø 9/11 mm	Ø 30 mm	M12	
AGT53.M12		Ø 9/11 mm	Ø 53 mm	M12	

Laccio tirante Noose

Articolo Item	Materiale laccio Lace material	Per sonde diametro For diameter fish tape	Tipo Type	Filettatura Threaded	Immagine Image
AL6.M5.1	Corda di acciaio Steel rope	Ø 3/4,5 mm	Singolo laccio Single noose	M5	
AL6.M5.3	Corda di acciaio Steel rope	Ø 3/4,5 mm	Triplo laccio Triple noose	M5	

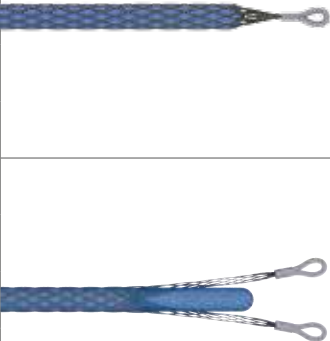
Calze tiranti Pulling braided wires

Articolo Item	Diametro sonda Diameter fish tape	Diametro cavi Cables diameter	Carico di lavoro/rottura Load working/breaking	Lunghezza in riposo/estensione Length Resting/Extension	Filetto Thread	Immagine Image
AC6.M5.49	Ø 3/4,5 mm	Ø 4/9 mm			M5	
AC6.M5.915	Ø 3/4,5 mm	Ø 9/15 mm			M5	
AC.2025	Ø 6/11 mm	Ø 20/25 mm	750/1600 Kg	400/800 mm		
AC.2545	Ø 6/11 mm	Ø 25/45 mm	1.500/4.600 Kg	750/1.300 mm		
AC.4560	Ø 6/11 mm	Ø 45/60 mm	2.500/5.500 Kg	900/1.400 mm		
AC.6080	Ø 6/11 mm	Ø 60/80 mm	2.500/5.500 Kg	1.200/1.900 mm		
AC.80100	Ø 6/11 mm	Ø 80/100 mm	3.000/6.000 Kg	1.300/2.000 mm		
AC.2025A	Ø 6/11 mm	Ø 20/25 mm	750/1600 Kg	400/800 mm		
AC.2545A	Ø 6/11 mm	Ø 25/45 mm	1.500/4.600 Kg	750/1.300 mm		
AC.4560A	Ø 6/11 mm	Ø 45/60 mm	2.500/5.500 Kg	900/1.400 mm		
AC.6080A	Ø 6/11 mm	Ø 60/80 mm	2.500/5.500 Kg	1.200/1.900 mm		
AC.80100A	Ø 6/11 mm	Ø 80/100 mm	3.000/6.000 Kg	1.300/2.000 mm		



Kit di riparazione per sonde in fibra di vetro Repair kit for fiberglass fish tapes

Articolo Item	Per sonde For fish tapes	Descrizione Description	Immagine Image
Per rotture centrali con giunto For central breaks with joint			
ASR30	Ø 3 mm	2 terminali da crimpare e 1 giunto fisso 2 terminals to be crimped, N.1 Fixed joint	
ASR35	Ø 3,5 mm		
ASR45	Ø 4,5 mm		
ASR6	Ø 6 mm		
ASR9	Ø 9 mm	2 terminali, 1 giunto girevole, 1 punta trapano Ø1.5 mm, 4 chiodini da ribadire 2 Terminals, 1 Swivel joint, 1 Hard tip Ø1.5 mm, 4 nails to be reiterated	
ASR11	Ø 11 mm		
Per rotture centrali For central breaks			
AGS30	Ø 3 mm	1 Giunto fisso da crimpare 1 Fixed joint to be crimped	
AGS35	Ø 3,5 mm		
AGS45	Ø 4,5 mm		
AGS6	Ø 6 mm		
AGS9	Ø 9 mm	1 Giunto fisso, 1 Punta trapano Ø1.5 mm, 2 Chiodini da ribadire 1 Fixed joint, 1 Hard tip Ø1.5 mm, 2 Nails to be reiterated	
AGS11	Ø 11 mm		
Per rotture terminali For terminal breaks			
AST30	Ø 3 mm	1 Terminale da crimpare 1 Terminal to be crimped	
AST35	Ø 3,5 mm		
AST45	Ø 4,5 mm		
AST6	Ø 6 mm		
AST9	Ø 9 mm	1 Terminale, 1 Punta trapano Ø1.5 mm, 2 Chiodini da ribadire 1 Terminal, 1 Hard tip Ø1.5 mm, 2 Nails to be reiterated	
AST11	Ø 11 mm		







Colla per kit di riparazione Glue for repair kit

Articolo Item	Descrizione Description	Quantità Quantity	Immagine Image
ACOLLA	Colla specifica per la riparazione di sonde in fibra di vetro Specific glue for the repair of fiberglass fish tapes	3 ml	

Espositori vuoti per sonde
Empty display for fish tapes

Articolo Item	Descrizione Description	Allestimento suggerito Suggested set-up	Immagine Image
<p>EXPO40</p>	<p>Espositore vuoto in acciaio verniciato a caldo con polveri epossidiche, colore bianco, dimensione 400x350 mm, altezza 2000 mm</p> <p>Empty display in steel, white color hot painted with powders epoxy, size 400x350 mm, height 2000 mm</p>	<p>4 tipologie di sonde diverse 4 Tipologie di accessori 15 Bottiglie di lubrificante</p> <p>4 types of different fish tapes 4 Types of accessories 15 Bottles of lubricant</p>	
<p>EXPO66</p>	<p>Espositore vuoto in acciaio verniciato a caldo con polveri epossidiche, colore bianco, dimensione 600x350 mm, altezza 2000 mm</p> <p>Empty display in steel, white color hot painted with powders epoxy, size 600x350 mm, height 2000 mm</p>	<p>8 tipologie di sonde diverse 5 Tipologie di accessori 24 Bottiglie di lubrificante</p> <p>8 types of different fish tapes 5 Types of accessories 24 bottles of lubricant</p>	

Avvolgitori per sonde Empty reels

Articolo Item	Descrizione Description	Per sonde For fish tapes	Immagine Image
ASB	Avvolgitore in materiale plastico dimensione \varnothing 300 mm con tirasonda in gomma e alloggiamento per accessori Plastic reel \varnothing 300 mm dimension with rubber rod and housing for accessories	Da \varnothing 3 a \varnothing 4,5 mm max 30 metri From \varnothing 3 to \varnothing 4,5 mm max 30 meters	
AC450	Avvolgitore in acciaio dimensione \varnothing 450 mm verniciato a caldo con polveri epossidiche, utilizzo orizzontale Epoxy powders hot-painted steel reel, \varnothing 450 mm dimension, horizontal use	Da \varnothing 5 a \varnothing 6 mm max 50 metri From \varnothing 5 to \varnothing 6 mm max 50 meters	
AC720	Avvolgitore in acciaio dimensione \varnothing 720 mm verniciato a caldo con polveri epossidiche, utilizzo orizzontale, Epoxy powders hot-painted steel reel, \varnothing 720 mm dimension, horizontal use	Da \varnothing 9 a \varnothing 10 mm max 60 metri From \varnothing 9 to \varnothing 10 mm max 60 meters	
AV350	Avvolgitore in acciaio dimensione \varnothing 350 mm verniciato a caldo con polveri epossidiche, utilizzo verticale e orizzontale Epoxy powders hot-painted steel reel, \varnothing 350 mm dimension, vertical and horizontal use	Da \varnothing 4 a \varnothing 6 mm max 60 metri From \varnothing 4 to \varnothing 6 mm max 60 meters	
AV550	Avvolgitore in acciaio dimensione \varnothing 600 mm verniciato a caldo con polveri epossidiche, utilizzo verticale e orizzontale, Epoxy powders hot-painted steel reel, \varnothing 600 mm dimension, vertical and horizontal use	Da \varnothing 5 a \varnothing 6 mm max 100 metri From \varnothing 5 to \varnothing 6 mm max 100 meters	
AV850	Avvolgitore in acciaio dimensione \varnothing 800 mm verniciato a caldo con polveri epossidiche, utilizzo verticale e orizzontale, Epoxy powders hot-painted steel reel, \varnothing 800 mm dimension, vertical and horizontal use	Da \varnothing 6 a \varnothing 9 mm max 150 metri From \varnothing 6 to \varnothing 9 mm max 150 meters	
AV1000	Avvolgitore in acciaio verniciato a caldo con polveri epossidiche, utilizzo verticale e orizzontale, dimensione \varnothing 1000 mm Hot-painted steel reel with epoxy powders, vertical and horizontal use, \varnothing 1000 mm dimension	\varnothing 9 a \varnothing 11 mm max 200 metri From \varnothing 9 to \varnothing 11 mm max 200 meters	

Gel lubrificante per cavi Cable lubricant gel

Articolo Item	Descrizione Description	Quantità Quantity	Immagine Image
AGI050	Gel lubrificante con alta viscosità per l'inserimento in lunghi tratti di cavi elettrici, cavi telefonici e cavi in fibra ottica. Il gel elimina l'attrito ed evita rovesciamenti indesiderati del prodotto sul pavimento che si potrebbe macchiare. Lubricant gel with high viscosity for insertion in long lines of electrical cables, telephone cables and fiber optic cables. The gel eliminates friction and avoids unwanted spilling of the product on the floor that could get stained.	500 ml	
AGI1		1000 ml	
AGI5		5000 ml	

Liquido lubrificante per cavi Cable lubricant liquid

Articolo Item	Descrizione Description	Quantità Quantity	Immagine Image
AGL050	Liquido lubrificante per ridurre al minimo l'attrito durante l'inserimento e l'estrazione dei cavi. Il liquido non unge, non macchia e una volta essiccato riveste i cavi con una pellicola protettiva che li rende inattaccabili dagli agenti corrosivi, preservandoli dall'invecchiamento. Lubricant LIQUID to reduce the friction during the insertion and pulling out of cables. The liquid is grease-proof, spots-proof and when dried it covers the cables with a protection film that makes them corrosive-proof, saving them from the aging.	500 ml	
AGL1		1000 ml	
AGL5		5000 ml	

Fluido lubrificante per cavi Cable lubricant fluid

Articolo Item	Descrizione Description	Quantità Quantity	Immagine Image
AGE050	Fluido lubrificante con bassa viscosità per ridurre al minimo l'attrito durante l'inserimento dei cavi. Questo fluido ha un alto potere lubrificante, molto adatto per cavi telefonici, cavi coassiali e cavi in fibra ottica. Lubricant fluid with low viscosity to reduce to the minimum the friction during the insertion of cables. This fluid has an high lubricant power, very suitable for telephone cables, coaxial cables and optical fiber cables.	500 ml	
AGE1		1000 ml	

Schiuma lubrificante per cavi Cable lubricant foam

Articolo Item	Descrizione Description	Quantità Quantity	Immagine Image
AGF400	Schiuma lubrificante biodegradabile, prodotto innovativo per facilitare l'introduzione e lo scorrimento delle sonde e dei cavi. La schiuma viene facilmente spinta anche in salita e nelle curve, diminuendo i punti di attrito. Biodegradable lubricant foam, innovative product to ease the insertion and the tapes and cables drifting. The foam is easily pushed also in upward and in bends, reducing the friction points.	400 ml	

Spray professionali Professional spray



Immagine Image				
Articolo Item	ALUB	ASBL	ADET	ARIA
Descrizione Description	Spray lubrificante al silicone per cavi Silicon lubricant spray for cables	Spray sbloccante e lubrificante Rust loosener and lubricant spray for cables	Spray detergente per contatti elettrici Spray cleaner for electrical contacts	Aria compressa antistatica per la pulizia di contatti Antistatic compressed air for cleaning electrical contacts
Quantità Quantity	400 ml	400 ml	400 ml	400 ml

Spray traccianti professionali Professional tracer spray



Immagine Image				
Articolo Item	ANERO	ABLU	AROSSO	AVERDE
Descrizione Description	Tracciante professionale da cantiere per l'edilizia civile ed impianti tecnici, con tappo erogatore speciale e cannula con azionamento easy touch per una miglior funzionalità e una maggior sicurezza. Professional construction site tracer for civil construction and technical systems, with special dispenser cap and cannula with easy touch operation for better functionality and greater safety.			
Quantità Quantity	400 ml	400 ml	400 ml	400 ml

Espositori in cartone per bombolette da 400 ml Cardboard displays for 400 ml spray cans



Articolo Item		Articolo Item	
EXPO-MAX30		EXPO-MAX96	
Descrizione Description	Espositore da banco in cartone per un totale di n. 30 bombolette da 400 ml (espositore vuoto) Counter display in cardboard for a total of n. 30 spray cans of 400 ml (empty display)	Descrizione Description	Espositore da banco in cartone per un totale di n. 96 bombolette da 400 ml (espositore vuoto) Counter display in cardboard for a total of n. 96 spray cans of 400 ml (empty display)



Caratteristiche Tecniche

- Rapporto di miscelazione: Automiscelante
- Rigidità dielettrica: 20 kV/mm
- Tempo di polimerizzazione: 15 minuti a 20°C
- Tempo di polimerizzazione totale: 24 h a 20°C
- Resistività di volume: $6 \times 10^{10} \Omega \text{ m}$
- Temperatura di utilizzo: da 5°C a 30°C
- Temperatura di esercizio: -20°C/200°C
- Temperatura di sovraccarico: 200°C
- Grado di protezione: IP68 (in involucri idonei)
- Caratteristiche: Atossico e sicuro, Bassa Viscosità
- Attenzione: Non conservare sotto 5°C e sopra 27°C
- Vantaggi: Riaccessibile

Technical features

- Mixing ratio: Self-mixing
- Dielectric strength: 20 kV/mm
- Polymerization time: 15 minutes at 20°C
- Total polymerization time: 24 h to 20°C
- Volume resistivity: $6 \times 10^{10} \Omega \text{ m}$
- Operating temperature: from 5°C to 30°C
- Working temperature: -20°C/200°C
- Overload temperature: 200°C
- Degree of protection: IP68 (in suitable box)
- Features: Non-toxic and safe, Low Viscosity
- Caution: Do not store below 5°C and above 27°C
- Advantage: Re-accessible

RAPIDGEL

Gel bicomponente IP68 con catalizzatore nel tappo
IP68 Liquid gel with catalyst in the cap



Articolo Item	Descrizione Description	Per scatole max For boxes max	Quantità Quantity	Immagine Image
GSR025	Gel liquido bicomponente 1 flacone da 250 g Two-component liquid gel 1 bottle of 250 g	80x80x40 mm	250 g	
GSR050	Gel liquido bicomponente 1 flacone da 500 g Two-component liquid gel 1 bottle of 500 g	100x100x60 mm	500 g	

Rapidgel è un'importante novità. Il nuovo gel siliconico bicomponente è confezionato in un singolo flacone ed è dotato di tappo con scomparto contenente il catalizzatore. Per usare il prodotto è sufficiente rimuovere il sigillo alla base del tappo, avvitare ulteriormente il tappo, e poi agitare bene il flacone per almeno 20/30 secondi in modo che il prodotto si misceli con il catalizzatore. Poi svitare il tappo e versare il prodotto.

Il vantaggio è che in un solo flacone hai tutto il necessario, senza perdere tempo a dosare e miscelare, ma soprattutto, non servono più caraffa e spatola, con un notevole risparmio di tempo (-30%), e un basso impatto ambientale grazie alla diminuzione di plastica utilizzata (-75%).

Rapidgel is an important innovation. The new two-component silicone gel is packaged in a single bottle and has a cap with a compartment containing the catalyst. To use the product simply remove the seal at the base of the cap, screw the cap further on, and then shake the bottle well for at least 20/30 seconds so that the product mixes with the catalyst. Then unscrew the cap and pour the product.

The advantage is that in a single bottle you have everything you need, without wasting time in dosing and mixing, but above all, no more jug and spatula are needed, with a considerable saving of time (-30%), and a low environmental impact thanks to the decrease in plastic used (-75%).



Effettuare la connessione elettrica utilizzando una scatola adeguata per raggiungere una protezione IP68.
Make the electrical connection using a suitable box to achieve protection IP68.



Asportare dal flacone il sigillo di protezione presente sul tappo, a mano o con l'ausilio di una pinza.
Remove the protective seal from the bottle cap, by hand or with the aid of pliers.



Premere il tappo verso il basso e ruotare in senso orario per forare il serbatoio dove alloggia il catalizzatore.
Press the cap down and turn clockwise to puncture the tank where the catalyst is housed.



Agitare energicamente il flacone per almeno 20/30 secondi in modo da miscelare bene i componenti interni.
Shake the bottle vigorously for at least 20/30 seconds to mix the internal components well.



Attendere 15 minuti ad una temperatura di 20°C, se la temperatura è inferiore la reticolazione sarà più lenta.
Wait 15 minutes at a temperature of 20°C, if the temperature is lower the reticulation will be slower.



Quando il gel è reticolato procedere con la chiusura della scatola di derivazione applicando il coperchio.
When the gel is reticulated, proceed with closing the junction box by applying the cover.



Caratteristiche Tecniche

- Rapporto di miscelazione: 1:1
- Rigidità dielettrica: 20 kV/mm
- Tempo di polimerizzazione: 15 minuti a 20°C
- Tempo di polimerizzazione totale: 24 h a 20°C
- Resistività di volume: $6 \times 10^{10} \Omega \text{ m}$
- Temperatura di utilizzo: da 5°C a 20°C
- Temperatura di esercizio: -20°C/200°C
- Temperatura di sovraccarico: 200°C
- Grado di protezione: IP68 (in involucri idonei)
- Caratteristiche: Atossico e sicuro, Bassa Viscosità
- Attenzione: Non conservare sotto 5°C e sopra 27°C
- Vantaggi: Riaccessibile

Technical features

- Mixing ratio: 1:1
- Dielectric strength: 20 kV/mm
- Polymerization time: 15 minutes at 20°C
- Total polymerization time: 24 h to 20°C
- Volume resistivity: $6 \times 10^{10} \Omega \text{ m}$
- Operating temperature: From 5°C to 20°C
- Working temperature: -20°C/200°C
- Overload temperature: 200°C
- Degree of protection: IP68 (in suitable box)
- Features: Non-toxic and safe, Low Viscosity
- Caution: Do not store below 5°C and above 27°C
- Advantage: Re-accessible

ISOLGEL

Gel liquido bicomponente isolante IP68 Bicomponent insulating liquid gel IP68



Articolo Item	Descrizione Description	Quantità Quantity	Immagine Image
GSB030	2 flaconi da 150 g (A+B) 2 bottles of 150 g (A+B)	300 g	
GSB030B	2 flaconi da 150 g (A+B), 1 caraffa graduata, 1 spatola 2 bottles of 150 g (A+B), 1 measuring pitcher, 1 spatola	300 g	
GSB1	2 flaconi da 500 g (A+B), 1 caraffa graduata, 1 spatola 2 bottles of 500 g (A+B), 1 measuring pitcher, 1 spatola	1 Kg	
GSB10	2 taniche da 5 Kg (A+B), 1 caraffa, 1 spatola 2 bottles of 5 Kg (A+B), 1 measuring pitcher, 1 spatola	10 Kg	
GSB030BL	1 busta da 260 g (A+B) per scatole 80x80x40 mm 1 Bag with 260 g (A+B) for boxes 80x80x40 mm	260 g	
GSB040BL	1 busta da 360 g (A+B) per scatole 100x100x60 mm 1 Bag with 360 g (A+B) for boxes 100x100x60 mm	360 g	



Effettuare la connessione elettrica utilizzando una scatola adeguata per raggiungere una protezione IP68.
Make the electrical connection using a suitable box to achieve protection IP68.



Versare i componenti A e B all'interno della caraffa facendo attenzione a che siano in pari quantità (1:1).
Pour components A and B into the pitcher making sure they are in equal quantities (1:1).



Mescolare bene i componenti A e B per almeno 30 secondi fino a quando il colore non è omogeneo.
Mix well components A and B for at least 30 seconds until the color is homogeneous.



Colare il gel all'interno della scatola di derivazione facendo attenzione a ricoprire tutte le connessioni.
Pour the gel into the junction box, taking care to cover all the connections.



Attendere 15 minuti ad una temperatura di 20°C, se la temperatura è inferiore la reticolazione sarà più lenta.
Wait 15 minutes at a temperature of 20°C, if the temperature is lower the reticulation will be slower.



Quando il gel è reticolato procedere con la chiusura della scatola di derivazione applicando il coperchio.
When the gel is reticulated, proceed with closing the junction box by applying the cover.

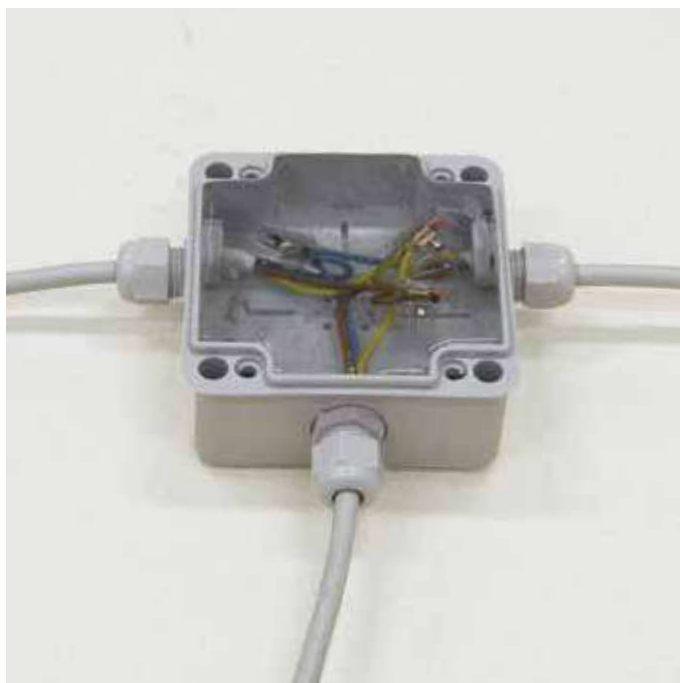

Caratteristiche Tecniche

- Monocomponente pronto all'uso
- Rigidità dielettrica: 9 kV/mm
- Resistività di volume: $1,2 \times 10^{10} \Omega \text{ m}$
- Temperatura di utilizzo: -20°C/200°C
- Temperatura di esercizio: -20°C/200°C
- Temperatura di sovraccarico: 200°C
- Grado di protezione: IP68 (in involucri idonei)
- Caratteristiche: Atossico e sicuro, Bassa Viscosità
- Attenzione: Non conservare sotto 5°C e sopra 27°C
- Vantaggi: Riaccessibile e riutilizzabile

Technical features

- Monocomponent ready for the use
- Dielectric strength: 9 kV/mm
- Volume resistivity: $1,2 \times 10^{10} \Omega \text{ m}$
- Operating temperature: -20°C/200°C
- Working temperature: -20°C/200°C
- Overload temperature: 200°C
- Degree of protection: IP68 (in suitable box)
- Features: Non-toxic and safe, Low Viscosity
- Caution: Do not store below 5°C and above 27°C
- Advantage: Re-accessible and reusable

PRONTOGEL

Gel monocomponente in pasta isolante IP68
One-component gel insulating paste IP68



Articolo Item	Descrizione Description	Quantità Quantity	Immagine Image
GSM030	Barattolo con gel monocomponente pronto all'uso Can with ready to use single-component gel	300 g	
GSM1	Barattolo con gel monocomponente pronto all'uso Can with ready to use single-component gel	1 Kg	



Realizzare la connessione e sigillare tutti i passaggi dei cavi con un sigillante per evitare la dispersione del prodotto.
Make the connection and seal all cable passages with a sealant to prevent product dispersion.



Prelevare il prodotto monocomponente dal barattolo e applicarlo all'interno della scatola di derivazione.
Take the single-component product from the can and apply it inside the junction box.



Prima di coprire le connessioni applicare del gel sul fondo della scatola di derivazione.
Before covering the connections apply some gel to the bottom of the junction box.



Ricoprire le connessioni facendo attenzione a non lasciare zone di vuoto tra i contatti.
Cover the connections paying attention not to leave empty areas between the contacts.



Lasciare del gel in esubero per una perfetta aderenza con il coperchio, attendere 5 minuti che il gel si autolivelli.
Leave some gel in excess for a perfect adherence with the cover, wait 5 minutes for the gel to self-level.



Quando il gel è livellato procedere con la chiusura della scatola di derivazione applicando il coperchio.
When the gel is leveled proceed with closing the junction box by applying the cover.



Caratteristiche Tecniche

- Monocomponente pronto all'uso
- Rigidità dielettrica: 9,6 kV/mm
- Resistività di volume: $2,3 \times 10^{10} \Omega \text{ m}$
- Temperatura di utilizzo: $-20^{\circ}\text{C}/200^{\circ}\text{C}$
- Temperatura di esercizio: $-20^{\circ}\text{C}/200^{\circ}\text{C}$
- Temperatura di sovraccarico: 200°C
- Grado di protezione: IP68 (in involucri idonei)
- Caratteristiche: Atossico e sicuro, Bassa Viscosità
- Attenzione: Non conservare sotto 5°C e sopra 27°C
- Vantaggi: Riaccessibile e riutilizzabile

Technical features

- Monocomponent ready for the use
- Dielectric strength: 9,6 kV/mm
- Volume resistivity: $2,3 \times 10^{10} \Omega \text{ m}$
- Operating temperature: $-20^{\circ}\text{C}/200^{\circ}\text{C}$
- Working temperature: $-20^{\circ}\text{C}/200^{\circ}\text{C}$
- Overload temperature: 200°C
- Degree of protection: IP68 (in suitable box)
- Features: Non-toxic and safe, Low Viscosity
- Caution: Do not store below 5°C and above 27°C
- Advantage: Re-accessible and reusable

SEALGEL

Gel monocomponente silicónico IP68 One-component silicone gel IP68



Articolo Item	Descrizione Description	Quantità Quantity	Immagine Image
GSM250	Tubetto con gel monocomponente pronto all'uso Tube with ready to use single-component gel	250 g	
GSM280	Cartuccia con gel monocomponente pronto all'uso Cartridge with ready to use single-component gel	280 g	



Realizzare la connessione e sigillare tutti i passaggi dei cavi con un sigillante per evitare la dispersione del prodotto.
Make the connection and seal all cable passages with a sealant to prevent product dispersion.



Riempire la scatola di derivazione.
Fill the junction box.



Prima di coprire le connessioni applicare del gel sul fondo della scatola di derivazione.
Before covering the connections apply some gel to the bottom of the junction box.

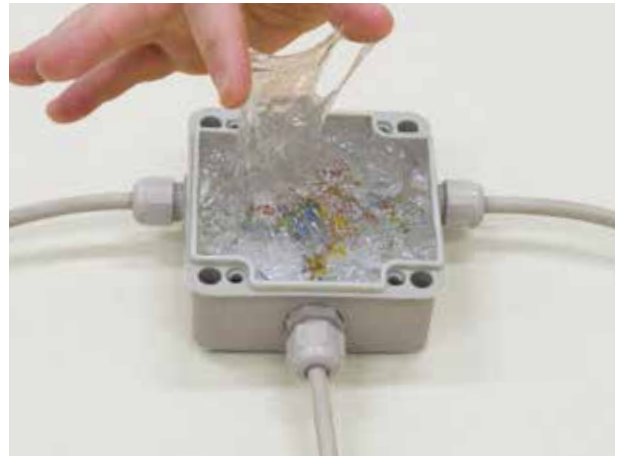

Ricoprire le connessioni facendo attenzione a non lasciare zone di vuoto tra i contatti.
Cover the connections paying attention not to leave empty areas between the contacts.



Lasciare del gel in esubero per una perfetta aderenza con il coperchio, attendere 5 minuti che il gel si autolivelli.
Leave some gel in excess for a perfect adherence with the cover, wait 5 minutes for the gel to self-level.



Quando il gel è livellato procedere con la chiusura della scatola di derivazione applicando il coperchio.
When the gel is leveled proceed with closing the junction box by applying the cover.



Caratteristiche Tecniche

- Rapporto di miscelazione: 1:1
- Rigidità dielettrica: 15 kV/mm
- Tempo di polimerizzazione: 15 minuti a 20°C
- Tempo di polimerizzazione totale: 24 h a 20°C
- Resistività di volume: $6 \times 10^{15} \Omega \text{ cm}$
- Temperatura di utilizzo: da 5°C a 30°C
- Temperatura di esercizio: -20°C/200°C
- Temperatura di sovraccarico: 200°C
- Grado di protezione: IP68 (in involucri idonei)
- Caratteristiche: Atossico e sicuro, Bassa Viscosità
- Attenzione: Non conservare sotto 5°C e sopra 27°C
- Vantaggi: Non riaccessibile



Technical features

- Mixing ratio: 1:1
- Dielectric strength: 15 kV/mm
- Polymerization time: 15 minutes at 20°C
- Total polymerization time: 24 h a 20°C
- Volume resistivity: $6 \times 10^{15} \Omega \text{ cm}$
- Operating temperature: From 5°C to 30°C
- Working temperature: from 5°C to 30°C
- Overload temperature: 200°C
- Degree of protection: IP68 (in suitable box)
- Features: Non-toxic and safe, Low Viscosity
- Caution: Do not store below 5°C and above 27°C
- Advantage: Not re-accessible

ISOLGOMMA

Gomma liquida bicomponente isolante IP68
Bicomponent insulating liquid rubber IP68



Articolo Item	Descrizione Description	Quantità Quantity	Immagine Image
GLB030	2 flaconi da 150 g (A+B), 1 caraffa graduata e 1 spatola 2 bottles of 150 g (A+B), 1 measuring pitcher and 1 spatula	300 g	
GLB1	2 flaconi da 500 g (A+B), 1 caraffa graduata e 1 spatola 2 bottles of 500 g (A+B), 1 measuring pitcher and 1 spatula	1 Kg	



Effettuare la connessione elettrica utilizzando una scatola adeguata per raggiungere una protezione IP68.
Make the electrical connection using a suitable box to achieve protection IP68.



Versare i componenti A e B all'interno della caraffa facendo attenzione a che siano in pari quantità (1:1).
Pour components A and B into the pitcher making sure they are in equal quantities (1:1).



Mescolare bene i componenti A e B per almeno 30 secondi fino a quando il colore non è omogeneo.
Mix well components A and B for at least 30 seconds until the color is homogeneous.



Colare la gomma all'interno della scatola di derivazione facendo attenzione a ricoprire tutte le connessioni.
Pour the rubber inside the junction box making sure to cover all connections.



Attendere 15 minuti ad una temperatura di 20°C, se la temperatura è inferiore la reticolazione sarà più lenta.
Wait 15 minutes at a temperature of 20°C, if the temperature is lower the reticulation will be slower.



Quando la gomma è reticolata procedere con la chiusura della scatola di derivazione applicando il coperchio.
When the rubber is reticulated, proceed with closing the junction box by applying the cover.

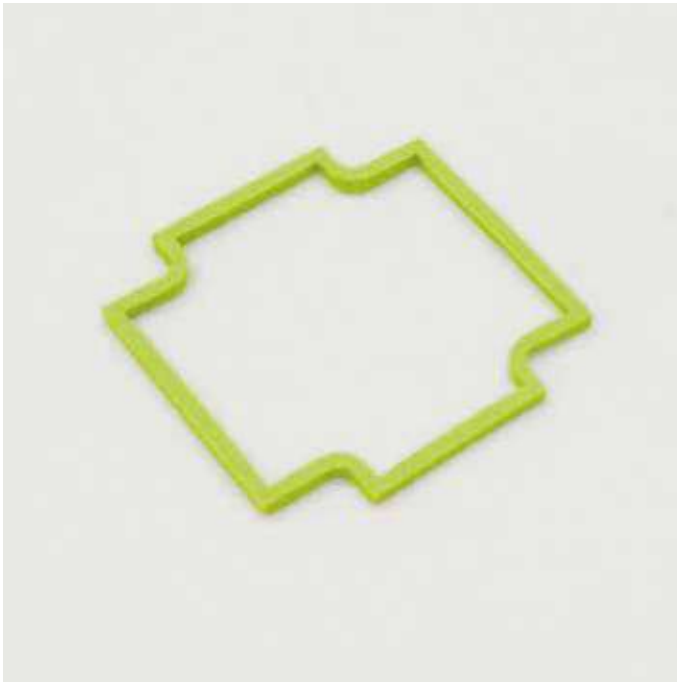

Caratteristiche Tecniche

- Rapporto di miscelazione: 1:1
- Rigidità dielettrica: 15 kV/mm
- Tempo di polimerizzazione: 15 minuti a 20°C
- Tempo di polimerizzazione totale: 24 h a 20°C
- Resistività di volume: $6,6 \times 10^{15} \Omega \text{ cm}$
- Temperatura di utilizzo: Da 5°C a 30°C
- Temperatura di esercizio: -20°C/200°C
- Temperatura di sovraccarico: 200°C
- Grado di protezione: IP68 (in involucri idonei)
- Caratteristiche: Atossico e sicuro, Bassa Viscosità
- Attenzione: Non conservare sotto 5°C e sopra 27°C
- Vantaggi: Non riaccessibile

Technical features

- Mixing ratio: 1:1
- Dielectric strength: 15 kV/mm
- Polymerization time: 15 minutes at 20°C
- Total polymerization time: 24 h to 20°C
- Volume resistivity: $6,6 \times 10^{15} \Omega \text{ cm}$
- Usage temperature: From 5°C to 30°C
- Operating temperature: -20°C/200°C
- Overload temperature: 200°C
- Degree of protection: IP68 (in suitable box)
- Features: Non-toxic and safe, Low Viscosity
- Caution: Do not store below 5°C and above 27°C
- Advantage: Not re-accessible

MAGICGOMMA

Gomma bicomponente in pasta isolante IP67
Bicomponent rubber insulating paste IP67



Articolo Item	Descrizione Description	Quantità Quantity	Immagine Image
GPB050	2 barattoli da 250 g (A+B) 2 bottles of 250 g (A+B)	500 gr	



Sostituire una guarnizione logora all'interno di una scatola di derivazione senza doverla sostituire e ricablare.
Replace a worn gasket inside an already installed junction box without having to replace it and rewire it again.



Prelevare i componenti A e B all'interno dei barattoli facendo attenzione che siano in pari quantità (1:1).
Take components A and B from the cans making sure they are in equal quantities (1: 1).



Mescolare bene i componenti A e B per almeno 30 secondi fino a quando il colore non diventa omogeneo.
Mix well components A and B for at least 30 seconds until the color becomes homogeneous.



Applicare la gomma all'interno della cavità dove era alloggiata la guarnizione precedente.
Apply the rubber inside the cavity where the previous gasket was housed.



Attendere circa 10 minuti ad una temperatura di 20°C, asportare la gomma in eccesso con un trincetto.
Wait about 15 minutes at a temperature of 20 °C, remove the excess rubber with a knife.



Quando la gomma è reticolata procedere con la chiusura della scatola di derivazione applicando il coperchio.
When the rubber is reticulated, proceed with closing the junction box by applying the cover.

KIT ISOLANTI

Kit isolanti bicomponenti IP68 IP68 bicomponent insulating kits



Articolo Item	Descrizione Description	Immagine Image
GI-BOX80	<p>1 scatola di derivazione 80x80x40 mm 1 busta di gel bicomponente da 260 g 3 pressacavi M20 per cavi da Ø11 a Ø17 mm 3 morsetti a levetta con 3 fori da 0,2 a 4 mm²</p> <p>(Per caratteristiche tecniche vedi pag.306)</p> <p>1 junction box 80x80x40 mm 1 bag of two-component gel to 260 g 3 cable glands M20 for cables from Ø11 to Ø17 mm 3 fast connectors with 3 holes from 0.2 to 4 mm²</p> <p>(For technical features see page 306)</p>	
GI-BOX100	<p>1 scatola di derivazione 100x100x60 mm 1 busta di gel bicomponente da 360 gr 3 pressacavi M20 per cavi da Ø11 a Ø17 mm 3 morsetti a levetta con 3 fori da 0,2 a 4 mm²</p> <p>(Per caratteristiche tecniche vedi pag.306)</p> <p>1 junction box 100x100x60 mm 1 bag of two-component gel to 360 gr 3 cable glands M20 for cables from Ø11 to Ø17 mm 3 fast connectors with 3 holes from 0.2 to 4 mm²</p> <p>(For technical features see page 306)</p>	
GL-BOX100	<p>1 scatola di derivazione 100x100x60 mm 1 busta di gel bicomponente da 360 g 3 pressacavi M20 per cavi da Ø11 a Ø17 mm 3 morsetti a levetta con 3 fori da 0,2 a 4 mm²</p> <p>(Per caratteristiche tecniche vedi pag.312)</p> <p>1 junction box 100x100x60 mm 1 bag of two-component gel to 360 g 3 cable glands M20 for cables from Ø11 to Ø17 mm 3 fast connectors with 3 holes from 0.2 to 4 mm²</p> <p>(For technical features see page 312)</p>	



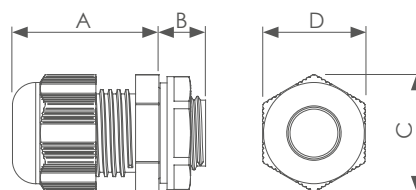

Pressacavi IP68 con controdado Cable glands IP68 with locknut

Grado di protezione: IP68 5 bar (30 min) IP66
Materiale pressacavo: Poliammide 6
Materiale guarnizione: Cloroprene
Temperatura d'esercizio: -20°C +100°C, intermittente -30 +150°C
Certificazioni: VDE, CSA, UL
Conformità: CE, RoHS 2015/863/EU
Protection degree: IP68 5 bar (30 min) IP66
Cable glands material: Polyamide 6
Sealing material: Chloroprene
Working temperature: -20°C +100°C, intermittent -30 +150°C
Approvals: VDE, CSA, UL
Compliance: CE, RoHS 2015/863/EU



SISTEMA DI SERRAGGIO ANTIVIBRAZIONE ANTIVIBRATION CLAMPING SYSTEM

Dimensione filettatura Thread size	Lunghezza filettatura Thread length	Campo di serraggio Clamping range			Dimensioni Dimensions				
					A mm	B mm	C mm	D mm	
								Corpo Body	Testa Head
M12	8	3-6,5	-	124M1201B	25,3	8	17	15	15
M16	8	4-8	-	124M1601B	27,4	8	21,7	19	19
M20	10	6-12	-	124M2001B	27	10	27	24	24
M25	8	11-17	-	124M2501B	37,7	8	37,7	29	29
M32	10	15-21	-	124M3201B	42,3	10	41	36	36
M40	10	19-28	-	124M4001B	47,4	10	52,4	46	46
PG7	8	3 - 6,5	124P0701B	124P0701BE	25,3	8	17	15	15
PG9	8	4 - 8	124P0901B	124P0901BE	27,4	8	21,7	19	19
PG11	8	5 - 10	124P1101B	124P1101BE	32,2	8	25	22	22
PG13,5	9	6 - 12	124P1301B	124P1301BE	32,4	10	27	24	24
PG16	10	10 - 14	124P1601B	124P1601BE	31,9	10	30,9	27	27
PG21	11	13 - 18	124P2101B	124P2101BE	38,4	11	37,2	33	33
PG29	11	18 - 25	124P2901B	124P2901BE	43,3	11	47,1	42	42

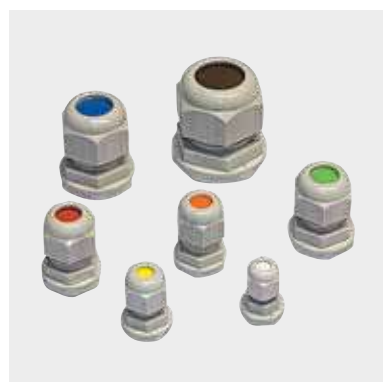

I pressacavi 124P..01B sono forniti con un tappo di protezione colorato.

The cable glands 124P .. 01B are supplied with coloured protection cap.

Tutti i pressacavi con codice finale B e BE (passo PG e Metrico) sono forniti con controdado e sono imballati in sacchetti con foro Euroslot.

The cable glands with final code B or BE (PG and Metric thread) are supplied with locknut and packaging with bag with Euroslot hole.



Pressacavi IP68 Cable glands IP68



<p>Grado di protezione: IP68 5 bar (30 min) IP66 Materiale pressacavo: Poliammide 6 Materiale guarnizione: Cloroprene Temperatura d'esercizio: -20°C +100°C, intermittente -30 +150°C Certificazioni: VDE, CSA, UL Conformità: CE, RoHS 2015/863/EU 124M...EX03: per ambienti a rischio di esplosione EEX e II livello "e" Protection degree: IP68 5 bar (30 min) IP66 Cable glands material: Polyamide 6 Sealing material: Chloroprene Working temperature: -20°C +100°C, intermittent -30 +150°C Approvals: VDE, CSA, UL Compliance: CE, RoHS 2015/863/EU 124M...EX03: for explosive areas EEX e II safety level "e"</p>	
---	--





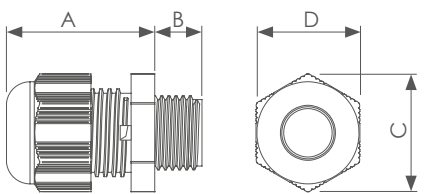

SISTEMA DI SERRAGGIO ANTIVIBRAZIONE ANTIVIBRATION CLAMPING SYSTEM

Dimensione filettatura Thread size	Lunghezza filettatura Thread length	Campo di serraggio Clamping range				Dimensioni Dimensions				
						A mm	B mm	C mm	D mm	
									Corpo Body	Testa Head
	mm	Ø mm	Grigio Grey RAL7035	Nero Black RAL9005	Nero Black RAL9005					
M12	8	3-6,5	350M1201	350M1203	124M12EX03	25,3	8	17	15	15
M16	8	4-8	350M1601	350M1603	124M16EX03	27,4	8	21,7	19	19
M20	10	6-12	350M2001	350M2003	124M20EX03	27	10	27	24	24
M25	8	11-17	350M2501	350M2503	124M25EX03	37,7	8	37,7	29	29
M32	10	15-21	350M3201	350M3203	124M32EX03	42,3	10	41	36	36
M40	10	19-28	350M4001	350M4003	124M40EX03	47,4	10	52,4	46	46
M50	18	30-38	350M5001	350M5003	-	54,8	18	67,8	60	60
M63	18	34-44	350M6301	350M6303	-	54,9	18	72,4	65	65
NPT3/8"	15	5-10	124NPT3801	-	-	32,2	15	25	22	22
NPT1/2"	15	6-12	124NPT1201	-	-	32,4	15	27	24	24
NPT3/4"	15	13-18	124NPT3401	-	-	38,4	15	37,2	33	33
NPT1"	18	18-25	124NPT101	-	-	43,3	18	47,1	42	42
PG7	8	3-6,5	350P0701	-	-	25,3	8	17	15	15
PG9	8	4-8	350P0901	-	-	27,4	8	21,7	19	19
PG11	8	5-10	350P1101	-	-	32,2	8	25	22	22
PG13,5	9	6-12	350P1301	-	-	32,4	10	27	24	24
PG16	10	10-14	350P1601	-	-	31,9	10	30,9	27	27
PG21	11	13-18	350P2101	-	-	38,4	11	37,2	33	33
PG29	11	18-25	350P2901	-	-	43,3	11	47,1	42	42
PG36	13	22-32	350P3601	-	-	52,4	13	59,6	53	53
PG42	13	30-38	350P4201	-	-	54,8	13	67,8	60	60
PG48	14	34-44	350P4801	-	-	54,9	14	72,4	65	65

Pressacavi con sistema di ventilazione anticondensa Cable glands with anti-condensation ventilation system

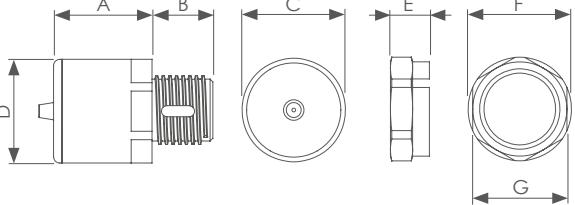
<p>Grado di protezione: IP67 Materiale pressacavo: Poliammide 6.6 Materiale guarnizione: Cloroprene Temperatura d'esercizio: -20°C +100°C Certificazioni: VDE, CSA, UL, DNV-GL Conformità: CE, RoHS 2015/863/EU Protection degree: IP67 Cable glands material: Polyamide 6 Sealing material: Chloroprene Working temperature: -20°C +100°C Approvals: VDE, CSA, UL, DNV-GL Compliance: CE, RoHS 2015/863/EU</p>										
Dimensione filettatura Thread size	Lunghezza filettatura Thread length	Campo di serraggio Clamping range	Flusso d'aria medio Average air flow ΔP = 70 mbar/1 psi	Passaggio d'acqua Water intrusion	 Grigio Grey RAL7035	Dimensioni Dimensions			 D mm	
	mm	mm	l/h	bar		A mm	B mm	C mm	Corpo Body	Testa Head
M12	8	4-7	25	0,1	350MV1201	28,3	8	21,7	19	19
M16	10	4-7	25	0,1	350MV1601	28,3	10	21,7	19	19
M20	10	6-11	40	0,1	350MV2001	33,3	10	27,0	24	24

Tappo di scarico anticondensa Anti-condensation drain plug

<p>Grado di protezione: IP56/IP66 (Categoria 2) Materiale pressacavo: Poliammide 66 (RAL7035) Temperatura d'esercizio: -20°C +100°C Certificazioni: VDE, CSA, UL, DNV-GL Conformità: CE, RoHS 2015/863/EU Protection degree: IP56/IP66 (Category 2) Cable glands material: Polyamide 66 (RAL7035) Working temperature: -20°C +100°C Approvals: VDE, CSA, UL, DNV-GL Compliance: CE, RoHS 2015/863/EU</p>											
Dimensione filettatura Thread size	Campo di serraggio Clamping range	 Tappo Plug	 Controdado Lock nut	Dimensioni Dimensions				Dimensioni Dimensions			
	mm			A mm	B mm	C mm	D mm	E mm	F mm	G mm	
M12	4-7	514MS12	3420MS12	17	12	19	18	7	19,2	18	

Il tappo 514MS12 può essere applicato sotto scatole di derivazione o quadri elettrici, la funzione è semplicissima, espelle per gravità la condensa che si può formare sul fondo degli involucri che subiscono sbalzi di temperatura tra l'interno e l'esterno.

The cap 514MS12 can be applied under derivation boxes or electrical panels, the function is very simple, by gravity it expels the condensate water that can form on the bottom of the casings that undergo temperature changes between the inside and the outside.

In che modo si forma la condensa all'interno di un involucro? How does condensation form inside an enclosure?

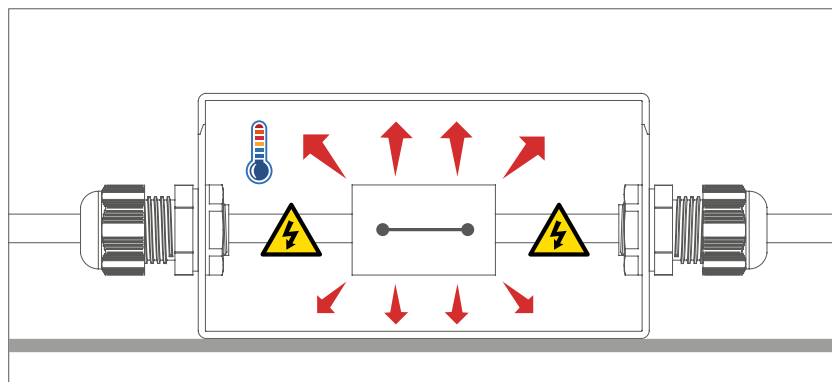

Durante il funzionamento le connessioni elettriche contenute all'interno dell'involucro emettono calore riscaldando a loro volta tutta la superficie che si mantiene calda per le ore successive.

During operation, the electrical connections contained within the casing emit heat, in turn heating the entire surface which remains hot for the following hours.

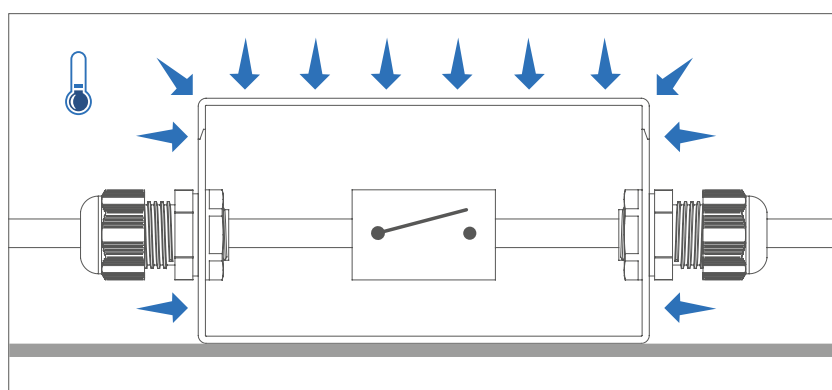

Dopo lo spegnimento o durante la notte le differenze di temperatura tra l'interno e l'esterno creano una bassa pressione all'interno dell'involucro che si trasforma in condensa.

After switching off or during the night, the temperature differences between the inside and the outside create a low pressure inside the casing which transforms into condensation.

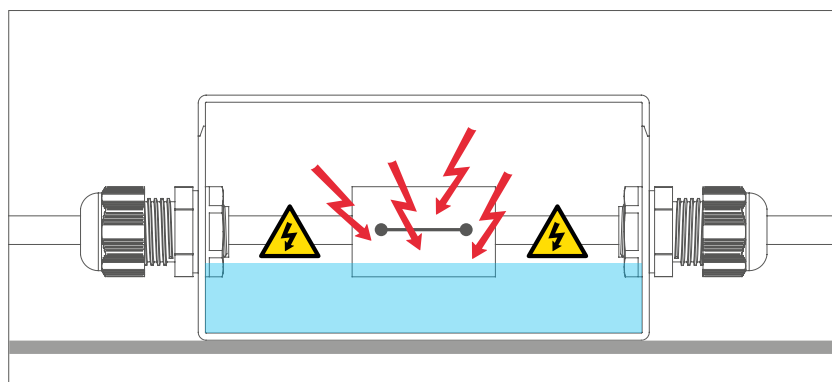

La condensa contenuta all'interno dell'involucro aggredisce le connessioni elettriche che a loro volta provocano un corto circuito creando danni irreparabili all'impianto collegato.

The condensation contained inside the casing attacks the electrical connections which in turn cause the short circuit, creating irreparable damage to the connected system.

Come funziona il pressacavo ventilato? How does the fan cable gland work?

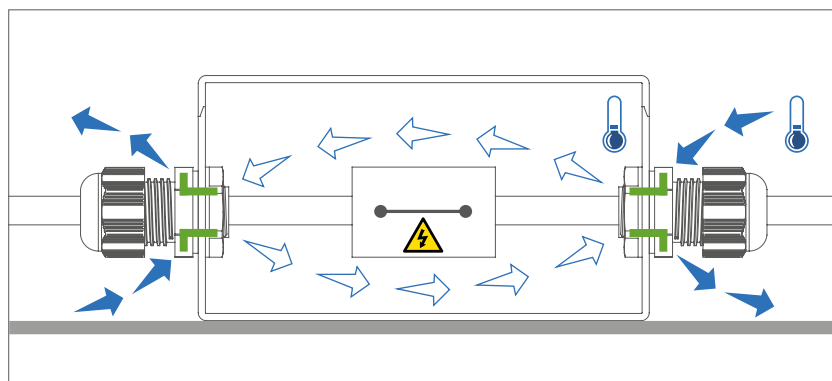

Questi pressacavi contengono al loro interno una membrana speciale in PTFE la quale consente un'elevata portata d'aria adattando perfettamente la pressione interna dell'involucro a quella esterna.

These cable glands contain a special PTFE membrane inside which allows a high air flow rate by perfectly adapting the internal pressure of the casing to the external one.

Pressacavi con proteggicavo IP68 Cable glands with cable protection IP68

Grado di protezione: IP68 5 bar (30 min) IP66
Materiale pressacavo: Poliammide 6
Materiale guarnizione: Cloroprene
Temperatura d'esercizio: -20°C +100°C, intermittente -30 +150°C
Certificazioni: VDE, CSA, UL
Conformità: CE, RoHS 2015/863/EU
Protection degree: IP68 5 bar (30 min) IP66
Cable glands material: Polyamide 6
Sealing material: Chloroprene
Working temperature: -20°C +100°C, intermittent -30 +150°C
Approvals: VDE, CSA, UL
Compliance: CE, RoHS 2015/863/EU

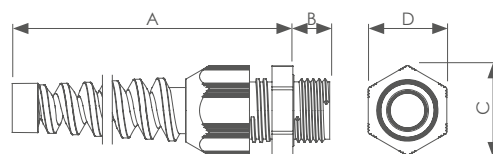

Dimensione filettatura Thread size	Lunghezza filettatura Thread length	Campo di serraggio Clamping range			Dimensioni Dimensions				
					A mm	B mm	C mm	D mm	
	mm	∅ mm	Grigio Grey RAL7035	Nero Black RAL9005				Corpo Body	Testa Head
M16	10	5-10	124SM1601	124SM1603	83,2	10	25,1	22	22
M20	10	10-14	124SM2001	124SM2003	106,4	10	30,5	27	27
M25	10	13-18	124SM2501	124SM2503	118,9	10	37,8	33	33

PG7	8	3-6,5	-	124SP0703	58	8	16,6	15	15
PG9	8	4-8	-	124SP0903	68,4	8	21,5	19	19
PG11	8	5-10	-	124SP1103	83,2	8	25,1	22	22
PG13,5	10	6-12	-	124SP1303	96,5	10	27,6	24	24
PG16	10	10-14	-	124SP1603	106,4	10	30,5	27	27

Pressacavi IP68 in OTTONE Cable glands IP68 of BRASS

<p>Grado di protezione: IP68 5 bar (30 min) IP66 Materiale pressacavo: Ottone nichelato Materiale guarnizione: Cloroprene Temperatura d'esercizio: -20°C +100°C, intermittente -40 +150°C Certificazioni: VDE, CSA, UL Conformità: CE, RoHS 2015/863/EU Protection degree: IP68 5 bar (30 min) IP66 Cable glands material: nickel plated Brass Sealing material: Chloroprene Working temperature: -20°C +100°C, intermittent -40 +150°C Approvals: VDE, CSA, UL Compliance: CE, RoHS 2015/863/EU</p>								
Dimensione filettatura Thread size	Lunghezza filettatura Thread length	Campo di serraggio Clamping range		Dimensioni Dimensions				
	mm	Ø mm		A mm	B mm	C mm	D mm	
							Corpo Body	Testa Head
M12	6	3-6,5	2532M12A	24	6	15,5	14	14
M16	7	4-8	2532M16A	25,5	7	20	17	18
M20	8	6-12	2532M20A	26,5	8	24,5	22	22
M25	8	10-14	2532M25A	30	8	30	24	27
M32	9	13-18	2532M32A	35	9	37,5	30	34
M40	9	18-25	2532M40A	40,5	9	48,5	40	43
M50	9	22-32	2532M50A	50	9	61	50	55
M63	14	34-44	2532M63A	55	14	75	64	68

Pressacavi IP68 con inserimento rapido SLIP-IN Cable glands IP68 with SLIP-IN quick insertion

Grado di protezione: IP68 5 bar (30 min) IP66
Materiale pressacavo: Poliammide 6
Materiale guarnizione: Cloroprene
Temperatura d'esercizio: -20°C +100°C, intermittente -30 +150°C
Spessore di fissaggio: minimo 0,5 mm e massimo 4 mm
Certificazioni: VDE, CSA, UL
Conformità: CE, RoHS 2015/863/EU
Protection degree: IP68 5 bar (30 min) IP66
Cable glands material: Polyamide 6
Sealing material: Chloroprene
Working temperature: -20°C +100°C, intermittent -30 +150°C
Fixing thickness: minimum 0.5 mm and maximum 4 mm
Approvals: VDE, CSA, UL
Compliance: CE, RoHS 2015/863/EU

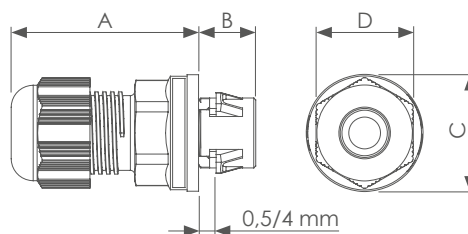

Dimensione foro Enclosure hole	Campo di serraggio Clamping range	Foro di fissaggio Insertion hole			Dimensioni Dimensions				
					A mm	B mm	C mm	D mm	
mm	∅ mm	∅ mm	Grigio Grey RAL7035	Nero Black RAL9005				Corpo Body	Testa Head
16,2 - 16,4	5-10	16	124M1601C	124M1603C	44,5	9	26,5	22	22
20,2 - 20,4	6-12	20	124M2001C	124M2003C	43,5	9	30,3	24	24
25,2 - 25,4	11-17	25	124M2501C	124M2503C	45,5	9	36,3	29	29
32,2 - 32,4	15-21	32	124M3201C	124M3203C	51,5	9	43,2	36	36
40,2 - 40,4	19-28	40	124M4001C	124M4003C	58	13,2	55,2	46	46



Inserire il pressacavo nel foro. Il pressacavo è fornito di guarnizione in gomma per garantire l'IP68.

Insert the cable gland in the hole. The cable gland is supplied with rubber seal to guarantee the IP68.



Premere a fondo fino allo scatto. Questo sistema innovativo riduce notevolmente i tempi d'installazione.

Press the cable gland until it clicks. This innovative system significantly reduces installation times.



Premere e girare contemporaneamente la base del pressacavo fino al completo bloccaggio.

Simultaneously press and turn the base of the cable gland until completely locked.

Pressacavi IP68 con inserimento rapido SLIP-IN in OTTONE Cable glands IP68 with SLIP-IN quick insertion of BRASS

<p>Grado di protezione: IP68 5 bar (30 min) IP66 Materiale pressacavo: Ottone Nichelato Materiale guarnizione: Cloroprene Temperatura d'esercizio: -20°C +100°C, intermittente -30 +150°C Spessore di fissaggio: min 0,5 mm, max 4 mm Certificazioni: VDE, CSA, UL Conformità: CE, RoHS 2015/863/EU Protection degree: IP68 5 bar (30 min) IP66 Cable glands material: Nickel-plated brass Sealing material: Chloroprene Working temperature: -20°C +100°C, intermittent -30 +150°C Fixing thickness: min 0,5 mm, max 4 mm Approvals: VDE, CSA, UL Compliance: CE, RoHS 2015/863/EU</p>								
Dimensione foro Enclosure hole	Campo di serraggio Clamping range	Foro di fissaggio Insertion hole		Dimensioni Dimensions				
				A mm	B mm	C mm	D mm	
mm	∅ mm	∅ mm				Corpo Body	Testa Head	
16,2 - 16,4	5-10	16	2532M16C	47	9	28,3	20	20
20,2 - 20,4	6-12	20	2532M20C	46	9	32,3	22	22
25,2 - 25,4	11-17	25	2532M25C	48	9	38,5	27	27
32,2 - 32,4	15-21	32	2532M32C	56,5	9	45,5	34	34
40,2 - 40,4	19-28	40	2532M40C	64	13,2	59	43	43

Attrezzo per disassemblare i pressacavi SLIP-IN Tool to disassemble SLIP-IN glands

Dimensione Size	Articolo Item		
M16	124M16DT		
M20	124M20DT		
M25	124M25DT		
M32	124M32DT		
M40	124M40DT		

Controdadi Locknuts

<p>Materiale: Poliammide 6 (Plastica) Ottone nichelato</p> <p>Temperatura d'esercizio: -20°C +100°C, intermittente -30 +150°C</p> <p>Conformità: CE, RoHS 2015/863/EU</p> <p>Material: Polyamide 6 (Plastic) Nickel plated Brass</p> <p>Working temperature: -20°C +100°C, intermittent -30 +150°C</p> <p>Compliance: CE, RoHS 2015/863/EU</p>							
Dimensione filettatura Thread size	Controdado Lock nut			Dimensioni Dimension			
				Plastica Plastic	Ottone Brass	Plastica Plastic	Ottone Brass
	Plastica grigia Grey plastic RAL7035	Plastica Nera Black plastic RAL9005	Ottone Brass	A mm	A mm	E mm	E mm
M12	3420M12	3420M1203	420M12	5	2,8	18	15
M16	3420M16	3420M1603	420M16	5	3	22	19
M20	3420M20	3420M2003	420M20	6	3,5	26	24
M25	3420M25	3420M2503	420M25	6	4	32	30
M32	3420M32	3420M3203	420M32	7	5	41	36
M40	3420M40	3420M4003	420M40	7	5	50	46
M50	3420M50	3420M5003	420M50	8	5	60	60
M63	3420M63	3420M6303	420M63	8	6	75	70
NPT3/8"	3420NPT3801			7		22	
NPT1/2"	3420NPT1201			7		27	
NPT3/4"	3420NPT3401			7		33	
NPT1"	3420NPT101			7		41	
PG7	3420P07			5		19	
PG9	3420P09			5		22	
PG11	3420P11			5		24	
PG13,5	3420P13			6		27	
PG16	3420P16			6		30	
PG21	3420P21			7		36	
PG29	3420P29			7		46	
PG36	3420P36			8		60	
PG42	3420P42			8		65	
PG48	3420P48			8		70	

Tappi filettati e guarnizioni Screw plugs and sealing rings

<p>Materiale: Poliammide 6 Temperatura d'esercizio: -20°C +100°C intermittente -30 +150°C Conformità: CE, RoHS 2015/863/EU Material: Polyamide 6 Working temperature: -20°C +100°C intermittent -30 +150°C Compliance: CE, RoHS 2015/863/EU</p>	<p>Materiale: gomma Dutral Temperatura d'esercizio: -40°C +100°C Conformità: CE, RoHS 2015/863/EU Material: Dutral rubber Working temperature: -40°C +100°C Compliance: CE, RoHS 2015/863/EU</p>
--	---



Dimensione filettatura Thread size	Tappo filettato Screw plug				Guarnizione Sealing ring			
	Plastica grigia Grey plastic RAL7035	B mm	C mm	D mm	Gomma nera Black rubber	B mm	C mm	D mm
M12	514M12	6	9	18	986DM12	1,5	18	11
M16	514M16	6	9,4	22	986DM16	1,5	21	15
M20	514M20	6	9	26	986DM20	1,5	27	19
M25	514M25	6	10	32	986DM25	1,5	34	24
M32	514M32	8	12	41	986DM32	1,5	40	32
M40	514M40	8	12,5	50	986DM40	1,5	51	39
M50	514M50	10	13,7	60	986DM50	1,5	60	48
M63	514M63	12	16,5	73	986DM63	1,5	72	62

PG7	514P07	6	9	15	986DP07	1,5	17	12
PG9	514P09	6	9	19,5	986DP09	1,5	20	15
PG11	514P11	6	9	22	986DP11	1,5	23	18
PG13,5	514P13	6	9	24,7	986DP13	1,5	25	20
PG16	514P16	6	9,4	27	986DP16	1,5	28	22
PG21	514P21	8	12	33	986DP21	1,5	38	28
PG29	514P29	8	11,2	44	986DP29	1,5	45	37
PG36	514P36	10	13,7	55	986DP36	1,5	56	47
PG42	514P42	10	16	62	986DP42	1,5	62	54
PG48	514P48	12	18,5	69	986DP48	1,5	69	59

Fascette per cablaggio Cable ties



Materiale: Poliammide 6.6 (Senza Alogeni)
Temperatura d'esercizio: -40°C +85°C
Temperatura di installazione: -10°C +60°C
Resistenza alla fiamma: UL94 V2
Conformità: CE, RoHS 2015/863/EU
Material: Polyamide 6.6 (Halogen Free)
Working temperature: -40°C +85°C
Installation temperature: -10°C +60°C
Flammability resistance: UL94 V2
Compliance: CE, RoHS 2015/863/EU

Dimensioni Dimensions		
	Neutro Neutral	Nero Black
mm		
100 x 2,5	F10025	F10025N
135 x 2,5	F14025	F14025N
160 x 2,5	F16025	F16025N
200 x 2,5	F20025	F20025N
140 x 3,6	F14036	F14036N
200 x 3,6	F20036	F20036N
290 x 3,6	F29036	F29036N
370 x 3,6	F36036	F36036N
120 x 4,5	F12048	F12048N
160 x 4,8	F16048	F16048N
200 x 4,8	F20048	F20048N
250 x 4,8	F25048	F25048N
290 x 4,8	F29048	F29048N
360 x 4,8	F36048	F36048N
390 x 4,8	F39048	F39048N
430 x 4,8	F43048	F43048N
180 x 7,8	F20076	F20076N
240 x 7,8	F25076	F25076N
300 x 7,8	F30076	F30076N
365 x 7,8	F36076	F36076N
450 x 7,5	F45076	F45076N
540 x 7,8	F54076	F54076N
750 x 7,5	F75076	F75076N
780 x 9,0	F78090	F78090N
500 x 12,5	F500125	F500125N
720 x 12,5	F720125	F720125N
850 x 12,5	F850125	F850125N
1000 x 12,5	F1000125	F1000125N

Fascette per cablaggio Cable ties



NEW

Materiale: Poliammide 6.6 (Senza Alogeni)
Temperatura d'esercizio: -40°C +85°C
Temperatura di installazione: -10°C +60°C
Resistenza alla fiamma: UL94 V2
Conformità: CE, RoHS 2015/863/EU
Material: Polyamide 6.6 (Halogen Free)
Working temperature: -40°C +85°C
Installation temperature: -10°C +60°C
Flammability resistance: UL94 V2
Compliance: CE, RoHS 2015/863/EU

Dimensioni Dimensions		
	Neutro Neutral	Nero Black
mm		
100 x 2,5	F10025I	F10025IN
135 x 2,5	F14025I	F14025IN
200 x 2,5	F20025I	F20025IN
290 x 3,6	F29036I	F29036IN
360 x 4,8	F36048I	F36048IN

Fascette per siglatura Cable ties for marking

Materiale: Poliammide 6.6 (Senza Alogeni)
Temperatura d'esercizio: -40°C +85°C
Temperatura di installazione: -10°C +60°C
Resistenza alla fiamma: UL94 V2
Conformità: CE, RoHS 2015/863/EU
Material: Polyamide 6.6 (Halogen Free)
Working temperature: -40°C +85°C
Installation temperature: -10°C +60°C
Flammability resistance: UL94 V2
Compliance: CE, RoHS 2015/863/EU

USO INTERNO INTERNAL USE		
Targhetta Plate	20 x 9 mm	25 x 8 mm
Dimensioni Dimensions		
mm	Neutro Neutral	Neutro Neutral
100 x 2,5	FTS10025	FT10025
200 x 2,5	-	FT20025
200 x 3,6	FTS20025	-

Fascette da installazione Installation cable ties

Materiale: Poliammide 6.6 (Senza Alogeni) Temperatura d'esercizio: -40°C +85°C Temperatura di installazione: -10°C +60°C Resistenza alla fiamma: UL94 V2 Conformità: CE, RoHS 2015/863/EU		Material: Polyamide 6.6 (Halogen Free) Working temperature: -40°C +85°C Installation temperature: -10°C +60°C Flammability resistance: UL94 V2 Compliance: CE, RoHS 2015/863/EU	
Dimensioni Dimensions	Articolo Item		Tenuta Load
200 x 8,8 mm	FI18090N		36 Kg
290 x 8,8 mm	FI26090N		55 Kg
380 x 8,8 mm	FI36090N		55 Kg

Supporti di fissaggio per fascette Fixing supports for cable ties

Materiale: Poliammide 6.6 (Senza Alogeni) Temperatura d'esercizio: -40°C +85°C Temperatura di installazione: -10°C +60°C Resistenza alla fiamma: UL94 V2 Conformità: CE, RoHS 2015/863/EU				Material: Polyamide 6.6 (Halogen Free) Working temperature: -40°C +85°C Installation temperature: -10°C +60°C Flammability resistance: UL94 V2 Compliance: CE, RoHS 2015/863/EU	
Fissaggio con adesivo Fixing with adhesive		Fissaggio con vite Fixing with screw		Fissaggio con vite Fixing with screw	
Neutro Neutral	Nero Black	Neutro Neutral	Nero Black	Neutro Neutral	Nero Black
FSA1919	FSA1919N	FSV1595	FSV1595N	FS0825	FS0825N
A = 20 mm B = 20 mm C = 5 mm D = 7 mm		A = 15 mm B = 10 mm C = 7 mm D = 3 mm E = 6 mm F = 5 mm		A = 20 mm B = 12 mm C = 13 mm D = 5 mm	
Per fascette larghezza max 5 mm For cable ties width max 5 mm		Per fascette larghezza max 4,8 mm For cable ties width max 4,8 mm		Per fascette larghezza 3,6mm For cable ties width 3,6 mm	
FSA2727	FSA2727N	FSV2216	FSV2216N		
A = 30 mm B = 30 mm C = 7 mm D = 9 mm		A = 20 mm B = 16 mm C = 9 mm D = 6 mm E = 9 mm F = 10 mm			
Per fascette larghezza max 7 mm For cable ties width max 7 mm		Per fascette larghezza max 8,8 mm For cable ties width max 8,8 mm			

Targhetta per siglatura Plate for labeling



Materiale: Poliammide 6.6 (Senza Alogeni)
Temperatura d'esercizio: -40°C +85°C
Temperatura di installazione: -10°C +60°C
Resistenza alla fiamma: UL94 V2
Conformità: CE, RoHS 2015/863/EU
Material: Polyamide 6.6 (Halogen Free)
Working temperature: -40°C +85°C
Installation temperature: -10°C +60°C
Flammability resistance: UL94 V2
Compliance: CE, RoHS 2015/863/EU

Per fascette For Cable Ties	
mm	Neutro Neutral
100 x 2,5	FTS1550 50x15 mm
135 x 2,5	
160 x 2,5	
200 x 2,5	

Tassello per fissaggio Anchor for fixing

Materiale: Poliammide 6.6 (Senza Alogeni)
Temperatura d'esercizio: -40°C +85°C
Temperatura di installazione: -10°C +60°C
Resistenza al calore: +110°C
Conformità: CE, RoHS 2015/863/EU
Material: Polyamide 6.6 (Halogen Free)
Working temperature: -40°C +85°C
Installation temperature: -10°C +60°C
Flammability resistance: UL94 V2
Compliance: CE, RoHS 2015/863/EU

	
Neutro Neutral	Nero Black
FT640	FT640N
Per fascette larghezza max 8,8 mm For cable ties width max 8,8 mm Foro da realizzare Ø8 mm x 40 mm Hole to be made Ø8 mm x 40 mm	

Utensile per la trazione delle fascette Tool for pulling the cable ties

Materiale: Acciaio
Finitura: Verniciata a caldo
Colore: Rosso
Per fascette: Standard e doppia testa
Conformità: CE, RoHS 2015/863/EU
Material: Steel
Finish: Hot painted
Colour: Red
For cable ties: Standard and double head
Compliance: CE, RoHS 2015/863/EU



Articolo Item	Descrizione Description
FUP95	Utensile per la trazione ed il taglio di fascette con larghezza da 2,5 mm a 9 mm Tool for pulling and cutting cable ties with a width from 2.5 mm to 9 mm

Fissatubo a fascetta doppia testa Cable tie clips double head

NEW

<p>Materiale: Poliammide Senza Alogeni Modello chiodatrice: Pulsa 800E (Chiodo HC6) Temperatura d'esercizio: -40°C +125°C Conformità: CE, RoHS 2015/863/EU Material: Polyamide Halogen Free Nailer model: Pulsa 800E (Nail HC6) Working temperature: -40°C +125°C Compliance: CE, RoHS 2015/863/EU</p>						
Articolo Item	Imballo Packing	Ø per tubi Ø for pipes	Dimensioni Dimensions			Immagine Image
			A mm	B mm	C mm	
<p>Colore grigio RAL7035 Colour grey RAL7035</p>						
S3190	In scatola In box	Da 8 a 32 mm From 8 to 32 mm	170	22	20	
S3190BL	In busta In bag					
S3290	In scatola In box	Da 16 a 63 mm From 16 to 63 mm	272	22	25	
S3290BL	In busta In bag					
<p>Colore nero Colour black</p>						
S3190N	In scatola In box	Da 8 a 32 mm From 8 to 32 mm	170	22	20	
S3290N	In scatola In box	Da 16 a 63 mm From 16 to 63 mm	272	22	25	
<p>Colore grigio RAL7035 con tassello di fissaggio 6x30 mm Colour grey RAL7035 with anchor 6x30 mm</p>						
S3190T	In scatola In box	Da 8 a 32 mm From 8 to 32 mm	170	22	20	
S3290T	In scatola In box	Da 16 a 63 mm From 16 to 63 mm	272	22	25	



Il fissatubo si inserisce a scatto sulla punta della chiodatrice

Snap the clip onto the tip of the nail gun



Fissatubo a fascetta Cable tie clips

<p>Materiale: Poliammide Senza Alogeni Colore: Grigio RAL7035 Vite per fissaggio: M4 x 30 mm Temperatura d'esercizio: -40°C +125°C Conformità: CE, RoHS 2015/863/EU Material: Polyamide Halogen Free Colour: Grey RAL7035 Fixing screw: M4 x 30 mm Working temperature: -40°C +125°C Compliance: CE, RoHS 2015/863/EU</p>						
Articolo Item	Imballo Packing	Ø per tubi Ø for pipes	Dimensioni Dimensions			
			A mm	B mm	C mm	
S0832	In scatola In box	Da 8 a 32 mm From 8 to 32 mm	172	20	25	
S0832BL	In busta In bag					
S1663	In scatola In box	Da 16 a 63 mm From 16 to 63 mm	270	20	25	
S1663BL	In busta In bag					

Fissatubo a clip con tassello e vite Snap clips with anchor and screw

<p>Materiale: Poliammide Senza Alogeni Dimensione tassello: Ø 6 x 30 mm Dimensione vite: 4,5 x 40 mm Colore: Grigio RAL7035 Temperatura d'esercizio: -25°C +85°C Conformità: CE, RoHS 2015/863/EU Material: Polyamide Halogen Free Anchor dimension: Ø 6 x 30 mm Screw dimension: Ø 4,5 x 40 mm Colour: Grey RAL7035 Working temperature: -25°C +85°C Compliance: CE, RoHS 2015/863/EU</p>							
Articolo Item	Imballo Packing	Per tubo For pipe	Dimensioni Dimensions				
			A mm	B mm	C mm	Asola fissaggio Fixing slot	
SCV16A	In scatola In box	Ø16 mm	30	25	11	4 x 8,5 mm	
SCV20A		Ø20 mm	35	28	11	4 x 8,5 mm	
SCV25A		Ø25 mm	40	30	11	4 x 8,5 mm	

Fissatubo a clip Snap clips

<p>Materiale: Poliammide Senza Alogeni Colore: Grigio RAL7035 Temperatura d'esercizio: -40°C +125°C Conformità: CE, RoHS 2015/863/EU</p> <p>Material: Polyamide Halogen Free Colour: Grey RAL7035 Working temperature: -40°C +125°C Compliance: CE, RoHS 2015/863/EU</p>							
Articolo Item	Imballo Packing	Per tubo For pipe	Dimensioni Dimensions				Asola fissaggio Fixing slot
			A mm	B mm	C mm		
SC16	In scatola In box	Ø16 mm	30	25	11	4 x 8,5 mm	
SC16BL	In busta In bag						
SC20	In scatola In box	Ø20 mm	35	28	11	4 x 8,5 mm	
SC20BL	In busta In bag						
SC25	In scatola In box	Ø25 mm	40	30	11	4 x 8,5 mm	
SC25BL	In busta In bag						
SC32	In scatola In box	Ø32 mm	45	36	11	4 x 8,5 mm	
SC32BL	In busta In bag						
SC40	In scatola In box	Ø40 mm	60	48	15	4,5 x 10 mm	
SC50	In scatola In box	Ø50 mm	70	57	15	4,5 x 10 mm	

I fissatubo a scatto e i fissatubo a pressione possono essere montati su guida a "C"
 The snap clips and the pressure clips can be mounted on "C" rail

I fissatubo a scatto e i fissatubo a pressione possono essere installati insieme grazie al sistema di accoppiamento presente su tutti e due i prodotti
 The snap clips and the pressure clips can be installed together thanks to the coupling system present on both products

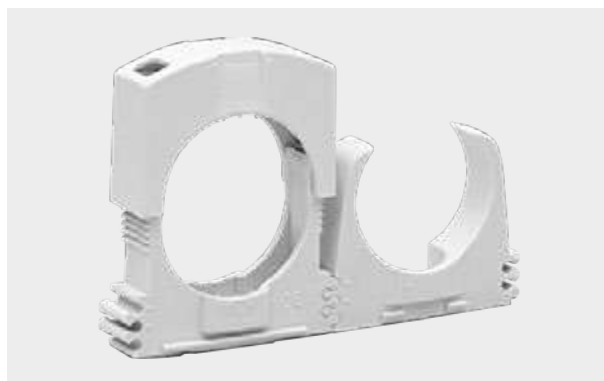
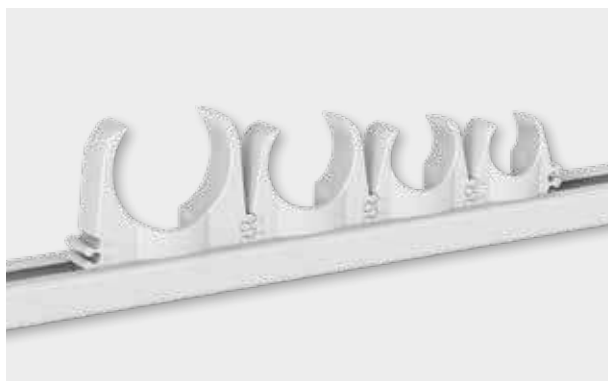

Fissatubo a pressione Pressure clips

<p>Materiale: Polipropilene con fibra di vetro Senza Alogeni Colore: Grigio RAL7035 Temperatura d'esercizio: -25°C +85°C Conformità: CE, RoHS 2015/863/EU Material: Polypropylene with fiberglass Halogen Free Colour: Grey RAL7035 Working temperature: -25°C +85°C Compliance: CE, RoHS 2015/863/EU</p>							
Articolo Item	Imballo Packing	Ø per tubi Ø for pipes	Dimensioni Dimensions				Asola fissaggio Fixing slot
			A mm	B mm	C mm		
S2036	In scatola In box	Da 12 a 20 mm From 12 to 20 mm	34	30	11	4 x 9,5 mm	
S2036BL	In busta In bag						
S2037	In scatola In box	Da 20 a 32 mm From 20 to 32 mm	47	35	11	4 x 12,5 mm	
S2037BL	In busta In bag						
S2039	In scatola In box	Da 32 a 50 mm From 32 to 50 mm	65	45	11	4 x 13,5 mm	



Fissatubo a collare in acciaio zincato Collar clamp of zinc plated steel

<p>Materiale: Acciaio Zincato Temperatura d'esercizio: -40°C +125°C Conformità: CE, RoHS 2015/863/EU Material: Galvanized Steel Working temperature: -40°C +125°C Compliance: CE, RoHS 2015/863/EU</p>						
Articolo Item	Tubi inseribili Insertable pipes	Dimensioni Dimensions				Asola fissaggio Fixing slot
		A mm	B mm	C mm		
S14.16	Da Ø14 a Ø16 mm From Ø14 to Ø16 mm	43	15	20	10 x 6 mm	
S19.23	Da Ø19 a Ø23 mm From Ø19 to Ø23 mm	50	15	30	10 x 6 mm	
S24.29	Da Ø24 a Ø29 mm From Ø24 to Ø29 mm	60	15	35	10 x 6 mm	
S30.38	Da Ø30 a Ø38 mm From Ø30 to Ø38 mm	70	15	38	10 x 6 mm	
S39.48	Da Ø39 a Ø48 mm From Ø39 to Ø48 mm	70	15	42	10 x 6 mm	
S48.52	Da Ø48 a Ø52 mm From Ø48 to Ø52 mm	88	15	57	10 x 6 mm	



Clip per cavi Cable clip

<p>Materiale: Poliammide Senza Alogeni Colore: Grigio RAL7035 Temperatura d'esercizio: -40°C +125°C Conformità: CE, RoHS 2015/863/EU Material: Polyamide Halogen Free Colour: Grey RAL7035 Working temperature: -40°C +125°C Compliance: CE, RoHS 2015/863/EU</p>						
Articolo Item	Cavi inseribili Insertable cables	Dimensioni Dimensions				
		A mm	B mm	C mm	Foro fissaggio Fixing hole	
S582BL	1xØ6 mm/1xØ10 mm/2xØ3 mm	48	15	30	Ø 4 mm	
S583BL	1xØ8 mm/1xØ16 mm	49	15	36	Ø 4 mm	

Supporto bloccatubi Pipes holder



<p>Materiale: Polipropilene Colore: Grigio RAL7035 Temperatura d'esercizio: -25°C +85°C Conformità: CE, RoHS 2015/863/EU Material: Polypropylene Colour: Grey RAL7035 Working temperature: -25°C +85°C Compliance: CE, RoHS 2015/863/EU</p>							
Articolo Item	Corrugati inseribili Insertable corrugated	Per fascette For cable ties	Asola fissaggio Fixing slot	A mm	B mm	C mm	
SPT6	6 da Ø16/Ø50 mm 6 from Ø16/Ø50 mm	L Max 9 mm	Ø 4x10 mm	290	20	45	

Fissaggio dei tubi con fascette larghezza max 9 mm
Pipe fixing with cable ties max width of 9 mm

I supporti sono accoppiabili
The supports can be coupled



Sistemi per il fissaggio di tubi a pavimento Systems for fixing pipes to the floor

<p>Materiale bandella: tessuto PP Temperatura d'esercizio: -40°C +125°C Conformità: CE, RoHS 2015/863/EU Fabric Strap material: Polypropylene Working temperature: -40°C +125°C Compliance: CE, RoHS 2015/863/EU</p>					
Articolo Item	Descrizione Description	Rotolo Roll	Dimensioni Dimensions		
			A mm	B mm	
SBT1508	Resistenza alla trazione: 200 Kg Tensile strength: 200 Kg	10 m	15	0,80	
SCP18	Acciaio temprato Tempered steel	Lunghezza 18 mm Length 18 mm			
SPC	Battichiodi con impugnatura in gomma ergonomica e protezione della mano Nail strikers with ergonomic rubber grip and hand protection				

<p>Materiale: Acciaio Zincato Conformità: CE, RoHS 2015/863/EU Material: zinc plated steel Compliance: CE, RoHS 2015/863/EU</p>					
Articolo Item	Rotolo Roll	Dimensioni Dimensions			
		A mm	B mm	C Ø mm	
519-12	10 m	12	0,75	4,5	
519-17	10 m	17	0,75	6	



Tassello Standard con vite testa svasata Standard anchor with screw

Materiale tassello: Poliammide Materiale vite: Acciaio Zincocromato Temperatura installazione: 0°C +40°C Temperatura d'esercizio: -40°C +80°C Conformità: CE, RoHS 2015/863/EU			Anchor material: Polyamide Screw material: hardened zinc plated steel Installation temperature: 0°C + 40°C Operating temperature: -40°C +80°C Compliance: CE, RoHS 2015/863/EU							
Articolo Item	Dimensioni Dimensions mm		Calcestruzzo non fessurato Non-cracked concrete	Mattoni pieno Solid brick	Mattoni forato Perforated brick	Blocco cemento forato Perforated concrete block	Cartongesso Drywall	Calcestruzzo cellulare Cellular concrete	Prodotto Product	Esempio di applicazione Application example
	Tassello Dowel	Vite Screw								
TV540	Ø5x25	M4x30	•	•		•				
TV645	Ø6x30	M4,5x40	•	•		•				
TV850	Ø8x40	M5x50	•	•		•				

Tassello multiespansione con vite Multiexpansion anchor with screw

Materiale tassello: Poliammide Materiale vite: Acciaio Zincocromato Temperatura installazione: 0°C +40°C Temperatura d'esercizio: -40°C +80°C Conformità: CE, RoHS 2015/863/EU			Anchor material: Polyamide Screw material: hardened zinc plated steel Installation temperature: 0°C + 40°C Operating temperature: -40°C +80°C Compliance: CE, RoHS 2015/863/EU							
Articolo Item	Dimensioni Dimensions mm		Calcestruzzo non fessurato Non-cracked concrete	Mattoni pieno Solid brick	Mattoni forato Perforated brick	Blocco cemento forato Perforated concrete block	Cartongesso Drywall	Calcestruzzo cellulare Cellular concrete	Prodotto Product	Esempio di applicazione Application example
	Tassello Dowel	Vite Screw								
TV6-525	Ø5x25	M4x30	•	•	•	•	•	•		
TV6-645	Ø6x30	M4,5x40	•	•	•	•	•	•		
TV6-850	Ø8x40	M5x50	•	•	•	•	•	•		







Guaina spiralata in Pvc e raccordi IP65

Pvc Spiral sheath and fittings IP65

Caratteristiche Guaina Sheath features				Caratteristiche Raccordi Fittings features				
<p>Materiale Guaina: Pvc Colore: Grigio RAL7035, Nero RAL9005 Resistenza al fuoco: UL94V0 Temperatura d'esercizio: -25°C +90°C Resistenza all'urto -5°C: 2J Resistenza schiacciamento: 350N Conformità: CE, RoHS 2015/863/EU</p> <p>Sheath material: Pvc Colour: Grey RAL7035, Black RAL9005 Fire resistant: UL94V0 Working temperature: -25°C +90°C Impact resistance -5°C: 2J Crushing resistance: 350N Compliance: CE, RoHS 2015/863/EU</p>				<p>Materiale Raccordi: Poliammide Colore: Grigio RAL7035, Nero RAL9005 Resistenza al fuoco: UL94V0 Temperatura d'esercizio: -25°C +90°C Grado di protezione: IP65 Conformità: CE, RoHS 2015/863/EU</p> <p>Fittings material: Polyamide Colour: Grey RAL7035, Black RAL9005 Fire resistant: UL94V0 Working temperature: -25°C +90°C Degree of protection: IP65 Compliance: CE, RoHS 2015/863/EU</p>				
Dimensione Guaina Sheath Dimension					Filettatura M Thread M	Filettatura M Thread M	Filettatura PG Thread PG	
	Grigio Grey		Nero Black					
	Rotolo 30 m Roll 30 m	Rotolo 10 m Roll 10 m	Rotolo 30 m Roll 30 m		Guaina/scatola Sheath/Box			
Ø10 mm	GS10	-	-	-	-	-	-	
Ø12 mm	GS12	-	GS12N	RGS12M16	RGS12M16N	RGS12P11	-	
Ø14 mm	GS14	-	-	-	-	RGS14P13	-	
Ø16 mm	GS16	GS16-10	GS16N	RGS16M20	RGS16M20N	RGS16P16	RGT16	
Ø20 mm	GS20	GS20-10	GS20N	RGS20M25	RGS20M25N	RGS20P21	RGT20	
Ø22 mm	GS22	-	-	-	-	-	-	
Ø25 mm	GS25	GS25-10	GS25N	RGS25M32	RGS25M32N	RGS25P29	RGT25	
Ø32 mm	GS32	-	GS32N	RGS32M40	RGS32M40N	RGS32P36	RGT32	
Ø40 mm	GS40	-	GS40N	RGS40M50	RGS40M50N	-	RGT40	
Ø50 mm	GS50	-	GS50N	RGS50M63	-	-	RGT50	
Ø60 mm	GS60	-	-	-	-	-	-	



Raccordi per tubo rigido Fittings for rigid pipe

Materiale Raccordi: Poliammide senza alogeni Colore: Grigio RAL7035 Resistenza al fuoco: UL94V0 Temperatura d'esercizio: -25°C +90°C Conformità: CE, RoHS 2015/863/EU				Fittings material: Polyamide halogen free Colour: Grey RAL7035 Fire resistant: UL94V0 Working temperature: -25°C +90°C Compliance: CE, RoHS 2015/863/EU		
Per tubo For pipe	Accessori IP67 Accessories IP67				Accessori IP40 Accessories IP40	
						
	Tubo/Scatola Pipe/Box	Tubo/Tubo Pipe/Pipe	Curva Tubo/Tubo Bend Pipe/Pipe	Curva flex Tubo/Tubo Flex bend Pipe/Pipe	Tubo/Tubo Pipe/Pipe	Curva Tubo/Tubo Bend Pipe/Pipe
Ø16 mm	RTS16	RTT16	RCS16	RCF16	MC16	CSR16
Ø20 mm	RTS20	RTT20	RCS20	RCF20	MC20	CSR20
Ø25 mm	RTS25	RTT25	RCS25	RCF25	MC25	CSR25
Ø32 mm	RTS32	RTT32	RCS32	RCF32	MC32	CSR32
Ø40 mm	RTS40	RTT40	RCS40	RCF40	MC40	CSR40
Ø50 mm	RTS50	RTT50	-	RCF50	MC50	CSR50

Giunti per tubo corrugato flessibile Joints for flexible corrugated pipe



Materiale Raccordi: Polipropilene Colore: Grigio RAL7035 Resistenza al fuoco: UL94V0 Temperatura d'esercizio: -5°C +95°C Conformità: CE, RoHS 2015/863/EU Fittings material: Polypropylene Colour: Grey RAL7035 Fire resistant: UL94V0 Working temperature: -5°C +95°C Compliance: CE, RoHS 2015/863/EU		
Per tubo For pipe		
	Tubo/Tubo Pipe/Pipe	
Ø16 mm	GC16	GCS16
Ø20 mm	GC20	GCS20
Ø25 mm	GC25	GCS25
Ø32 mm	GC32	GCS32



I giunti **GCS** sono adatti alle gettate liquide per pavimentazioni in calcestruzzo cellulare
 Joints **GCS** are suitable for cast concrete for cellular concrete floors



POLIBOX Pozzetti elettrici con cilindro portapalo
POLIBOX Well boxes with pole holder cylinder



<p>Materiale base: Polipropilene Materiale coperchio: Polipropilene Temperatura d'esercizio: -15°C +90°C Tipologia: Fondo chiuso pretranciato Test di prova: UNI EN 124 Conformità: CE, RoHS 2015/863/EU</p> <p>Base material: Polypropylene Cover material: Polypropylene Working temperature: -15°C +90°C Typology: Pre-cut closed bottom Proof test: UNI EN 124 Compliance: CE, RoHS 2015/863/EU</p>							
Immagine Image	Articolo Item	Descrizione Description	Colore coperchio Cover color	Carico max Max loading	A mm	B mm	C mm
	2525V	Pozzetto con coperchio Well box with cover	Verde Prato Green Grass	300 Kg	250	250	250
	C2525V	Coperchio di ricambio Replacement cover					
	2525G	Pozzetto con coperchio Well box with cover	Grigio Pietra Grey Stone	300 Kg	250	250	250
	C2525G	Coperchio di ricambio Replacement cover					

Questo pozzetto con cilindro portapalo integrato permette l'installazione di un palo di illuminazione Ø60 mm (Si consiglia di utilizzare pali con altezza massima 1,5 m).

Il diametro interno del cilindro è maggiorato, per potere recuperare un'eventuale pendenza del terreno di max 4°. Una volta posizionato il palo e fissato nella posizione desiderata, lo spazio attorno dovrà essere riempito con sabbia o schiumogeno.

Per l'applicazione della scatola di derivazione sulla testa del palo vedi pagina 347

This well box with integrated pole-holding cylinder allows the installation of a Ø60 mm lighting pole (We recommend using poles with a maximum height of 1.5 m).

The internal diameter of the cylinder is increased, to be able to recover a possible slope of the ground of max 4°. Once the pole has been positioned and fixed in the desired position, the space around it must be filled with sand or foam.

For the application of the junction box on the top of the pole, see page 347



I pozzetti portapalo Polibox hanno un cilindro interno per l'inserimento di un palo d'illuminazione Ø 60 mm, sono forniti con 4 viti in acciaio inox e 1 flangia di finitura.

The Polibox well boxes have an internal cylinder for the insertion of a Ø 60 mm lighting pole, they are supplied with 4 stainless steel screws and 1 finishing flange.

Il coperchio con il bordo maggiorato evita che lo sporco si depositi nelle fessure tra base e coperchio garantendo l'estrazione del coperchio in maniera facile e veloce.

The cover with the increased edge prevents dirt from settling in the cracks between the base and the cover, ensuring the removal of the cover quickly and easily.

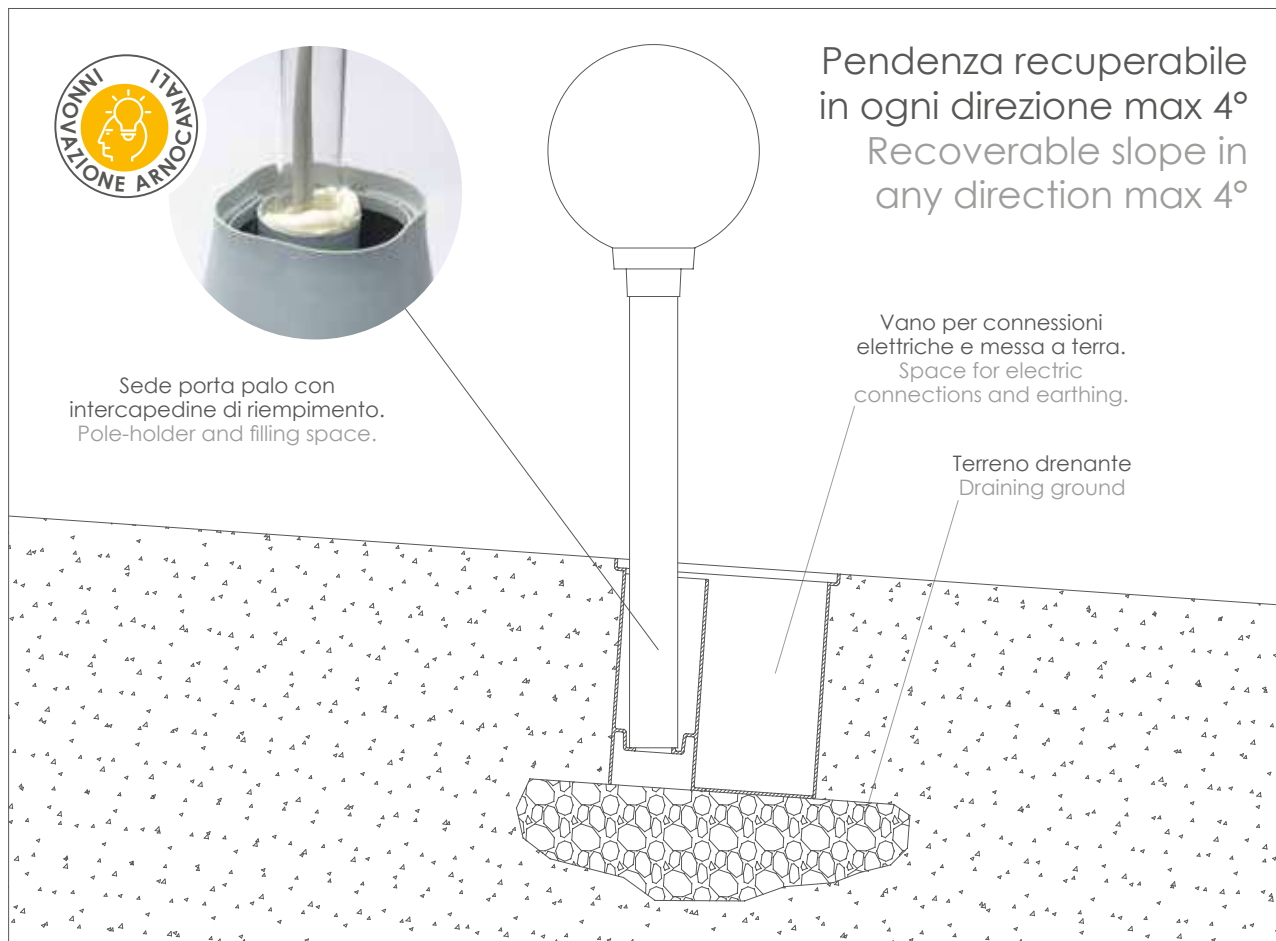

DRAINBOX Pozzetti elettrici e per irrigazione
DRAINBOX Electric and irrigation well boxes



Materiale base: Polipropilene
Materiale coperchio: Polipropilene
Temperatura d'esercizio: -15°C +60°C
Tipologia: fondo aperto (PB1520 chiuso)
Test di prova carico massimo: UNI EN 124
Conformità: CE, RoHS 2015/863/EU

Base material: Polypropylene
Cover material: Polypropylene
Working temperature: -15°C +60°C
Typology: opened bottom (PB1520 closed)
Max loading proof test: UNI EN 124
Compliance: CE, RoHS 2015/863/EU

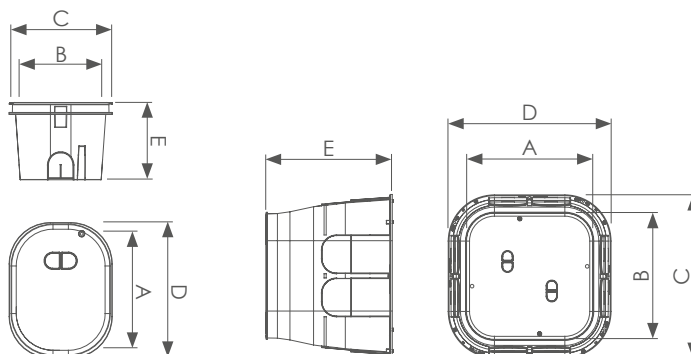

Articolo Item		Colore coperchio Cover color	Carico max Max loading	A mm	B mm	C mm	D mm	E mm
	PB1520V	Verde Prato Green Grass	130 Kg	170	125	155	200	120
	PB1520G	Grigio Pietra Grey Stone						
	PB1520R	Rosso Mattone Red brick						
	PB2020V	Verde Prato Green Grass	400 Kg	180	180	250	250	210
	PB2020G	Grigio Pietra Grey Stone						
	PB2020R	Rosso Mattone Red brick						
	PB3030V	Verde Prato Green Grass	500 Kg	230	230	320	320	230
	PB3030G	Grigio Pietra Grey Stone						
	PB3030R	Rosso Mattone Red brick						
	PB4040V	Verde Prato Green Grass	500 Kg	300	300	405	405	300
	PB4040G	Grigio Pietra Grey Stone						
	PB4040R	Rosso Mattone Red brick						

DRAINBOX Pozzetti elettrici e per irrigazione DRAINBOX Electric and irrigation well boxes



<p>Materiale base: Polipropilene Materiale coperchio: Polipropilene Temperatura d'esercizio: -15°C +60°C Tipologia: fondo aperto Test di prova carico massimo: UNI EN 124 Conformità: CE, RoHS 2015/863/EU</p> <p>Base material: Polypropylene Cover material: Polypropylene Working temperature: -15°C +60°C Typology: opened bottom Max loading proof test: UNI EN 124 Compliance: CE, RoHS 2015/863/EU</p>								
Immagine Image	Articolo Item	Colore coperchio Cover color	Carico max Max loading	A mm	B mm	C mm	D mm	E mm
	PB4050V	Verde Prato Green Grass	1200 Kg	405	280	525	395	300
	PB4050G	Grigio Pietra Grey Stone						
	PB5060V	Verde Prato Green Grass	600 Kg	455	380	605	520	300
	PB5060G	Grigio Pietra Grey Stone						

Colori disponibili dei coperchi Available colors of the covers

Verde Prato Green Grass	Grigio Pietra Grey Stone	Rosso Mattone Red brick

Kit portapalo Ø60 mm
Ø60 mm pole holder kit

Articolo Item	Descrizione Description	Immagine Image
PBR60	<p>N.1 Cilindro portapalo N.1 Flangia di rifinitura N.1 Scatola di derivazione</p> <p>Il Kit può essere installato solo sui pozzetti PB2020, PB3030, PB4040</p> <p>N.1 Pole cylinder N.1 Finishing flange N.1 Junction box</p> <p>The Kit can be installed only on the wells PB2020, PB3030, PB4040</p>	

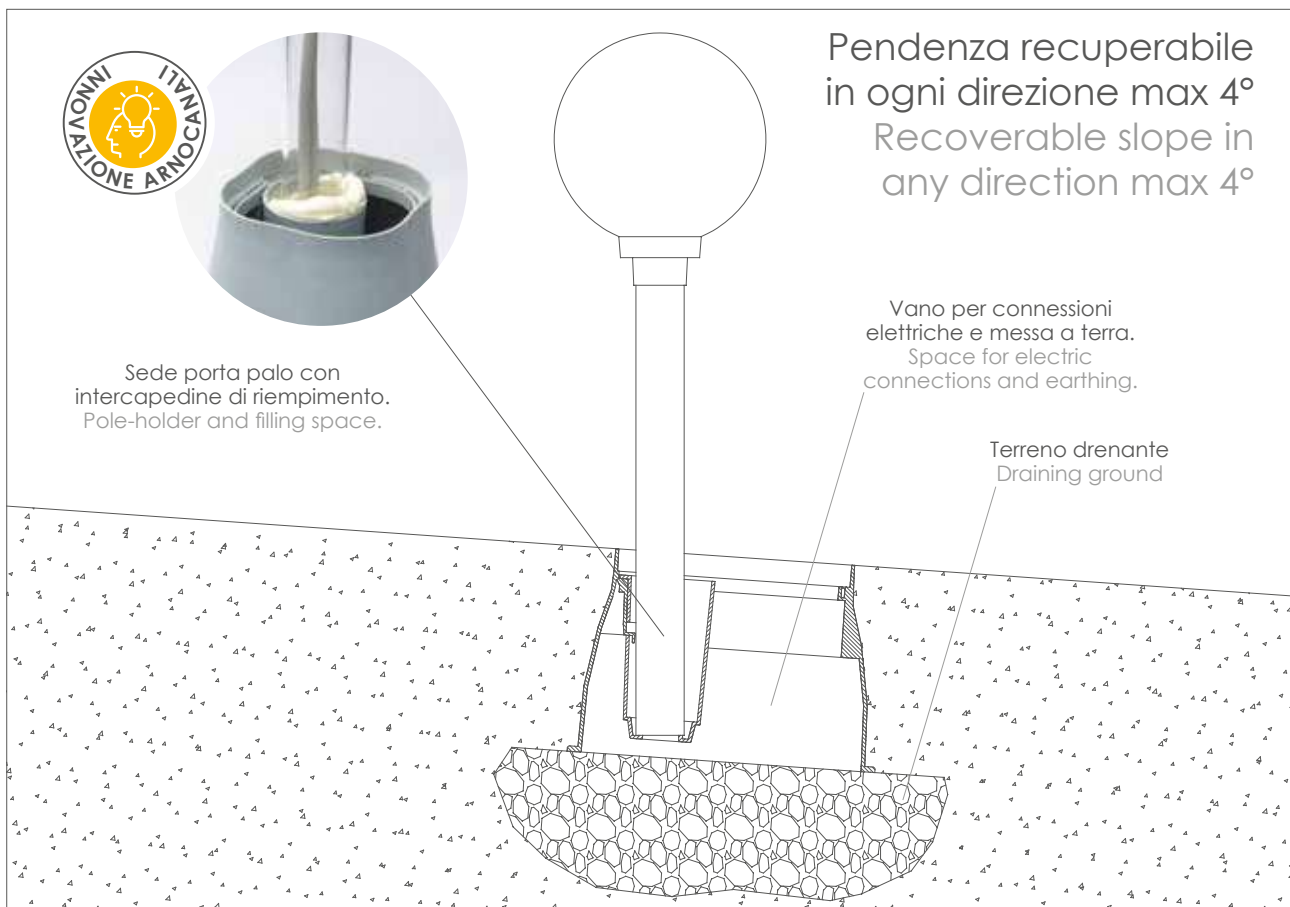

Questo pozzetto con cilindro portapalo permette l'installazione di un palo di illuminazione Ø60 mm (Si consiglia di utilizzare pali con altezza massima 1,5 m).
Il diametro interno del cilindro è maggiorato, per potere recuperare un'eventuale pendenza del terreno di max 4°. Una volta posizionato il palo e fissato nella posizione desiderata, lo spazio attorno dovrà essere riempito con sabbia o schiumogeno.
Per l'applicazione della scatola di derivazione sulla testa del palo vedi pagina 347

This well box with pole-holding cylinder allows the installation of a Ø60 mm lighting pole (We recommend using poles with a maximum height of 1.5 m).
The internal diameter of the cylinder is increased, to be able to recover a possible slope of the ground of max 4°. Once the pole has been positioned and fixed in the desired position, the space around it must be filled with sand or foam.
For the application of the junction box on the top of the pole, see page 347

Guida DIN Omega 3 per pozzetti DRAINBOX Omega 3 DIN rail for well boxes DRAINBOX

Articolo Item	Descrizione Description	Immagine Image	
PGD	Con questo accessorio è possibile applicare all'interno dei pozzetti morsetti o morsettiere di terra. With this accessory it is possible to apply terminals or ground terminal blocks inside the well boxes.		

Fondo chiuso e separatore per pozzetti DRAINBOX Closed bottom and separator for well boxes DRAINBOX

Articolo Item	Descrizione Description	Immagine Image	
PF2020	Accessorio per chiudere il fondo del pozzetto e separarlo internamente (separatoro disponibile solo per pozzetti PB2020, PB3030, PB4040) Accessory to close the bottom of the well box and to separate it internally (separatoro available only for well boxes PB2020, PB3030, PB4040)		
PF3030			
PF4040			
PF4050			

Giunto in gel e supporto di fissaggio Gel joint and fixing support

Articolo Item	Descrizione Description	Immagine Image	
PM2	Giunto in gel bipolare Bipolar gel joint		
PRM4	Supporto per max 4 giunti Support for max 4 joints		

Fresa a tazza per taglio coperchio Hole saw for cover cutting

Articolo Item	Descrizione Description	Immagine Image	
PFT90	Fresa a tazza Ø 90 mm Hoe saw Ø 90 mm		

Dimensione cavidotti installabili nei pozzetti Drainbox Pipes dimensions that can be installed with well boxes Drainbox

Articolo Item	Ø25 mm	Ø30 mm	Ø40 mm	Ø50 mm	Ø63 mm	Ø75 mm	Ø90 mm	Ø110 mm	Ø125 mm	Ø140 mm	Ø160 mm	Ø200 mm
PB1520	•	•	•	•								
PB2020			•	•	•	•	•	•				
PB3030					•	•	•	•	•			
PB4040							•	•	•	•	•	
PB4050					•	•	•	•	•	•	•	
PB5060							•	•	•	•	•	•

1	PB2020	n.1 rubinetto presa acqua n.1 water tap
2	PB3030	Da min 1 a max 2 elettrovalvole From min 1 to max 2 solenoid valves
3	PB4040	Da min 2 a max 4 elettrovalvole From min 2 to max 4 solenoid valves
4	PB4050	Da min 3 a max 4 elettrovalvole From min 3 to max 4 solenoid valves
5	PB5060	Da min 4 a max 8 elettrovalvole From min 4 to max 8 solenoid valves

**Quantità elettrovalvole
installabili nei pozzetti Drainbox**
Quantity of solenoid valves
installable in well boxes Drainbox

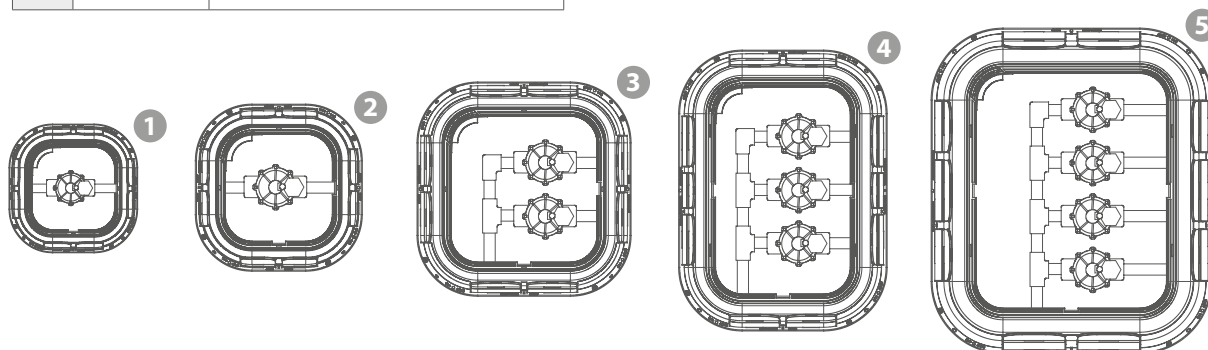

Con l'ausilio di un robusto trincetto si asportano i diaframmi pretranciati

With the help of a sturdy cutter the pre-cutting part are removed

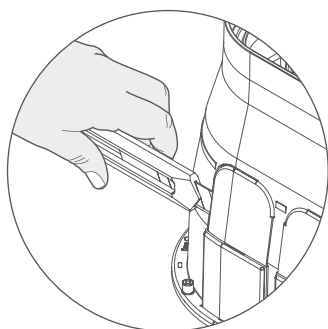

**PATENTED
BREVETTATO**

È possibile applicare i pozzetti dopo la posa dei cavidotti o dei tubi per irrigazione asportando i diaframmi pretranciati

Well boxes can be applied after laying the cable ducts or the irrigation pipes by removing the pre-cut diaphragms

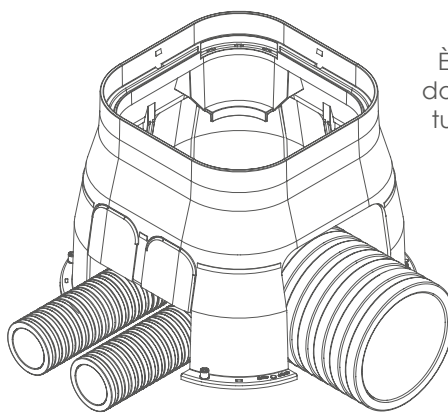



Pali in vetroresina Ø60 mm Fiberglass poles Ø60 mm

Articolo Item	Lunghezza Length	Colore Colour	Temperatura Temperature	Spessore Thickness	Interramento Burial
PVR10	1000 mm	Nero Black	-25°C +85°C	2,5 mm	320 mm
PVR15	1500 mm				380 mm
PVR20	2000 mm				440 mm
PVR25	2500 mm				500 mm
PVR30	3000 mm				560 mm
PVR35	3500 mm				620 mm
PVR40	4000 mm				680 mm



Scatola di derivazione per pali Ø60 mm Junction box for Ø60 mm poles



Articolo Item	Materiale Material	Dimensione Dimension	Descrizione Description
PVR60	Polipropilene Polypropylene	Ø52x170 mm	Scatola vuota Empty box
PVR60M			Scatola con 3 morsetti da 6 mm ² Box with 3 terminals of 6 mm ²



Questa scatola di derivazione, da installare al culmine del palo, mantiene le connessioni sempre pulite e asciutte, distanti dal terreno, protette dall'umidità e dall'acqua che potrebbe creare cortocircuiti dell'impianto. Molto spesso si trovano i pozzetti allagati e non è sicuro e piacevole dover operare con le mani nell'acqua. Inoltre si può effettuare la manutenzione restando in piedi senza doversi abbassare fino al terreno. Una soluzione funzionale e innovativa per tutti i corpi illuminanti del giardino.

This derivation box, to be installed at the top of the pole, keeps the connections always clean and dry, away from the ground, protected from moisture and water which could create short circuits in the system. Very often the wells are flooded and it is not safe and pleasant to have to work with your hands in the water. In addition, maintenance can be carried out while standing without having to go down to the ground. A functional and innovative solution for all lighting fixtures in the garden.



IDRABOX Pozzetti elettrici e idraulici con fondo chiuso
IDRABOX Electric and hydraulic well boxes with closed bottom



Materiale base: Polipropilene
Materiale coperchio: Polipropilene
Temperatura d'esercizio: -15°C +60°C
Tipologia: Fondo chiuso
Test di prova: UNI EN 124
Conformità: CE, RoHS 2015/863/EU

Base material: Polypropylene
Cover material: Polypropylene
Working temperature: -15°C +60°C
Typology: Closed bottom
Proof test: UNI EN 124
Compliance: CE, RoHS 2015/863/EU

Immagine Image	Articolo Item	Colore coperchio Cover color	Carico max Max loading	A mm	B mm	C mm	D mm	E mm
	PZ1520G	Grigio Pietra Grey Stone	100 Kg	175	125	150	200	155
	PZ1818G	Grigio Pietra Grey Stone	350 Kg	125	125	180	180	185
	PZ2323G	Grigio Pietra Grey Stone	300 Kg	170	170	230	230	235
	PZ3232G	Grigio Pietra Grey Stone	400 Kg	215	215	300	300	300

Corretta installazione dei pozzetti idraulici Correct installation for rainwater box

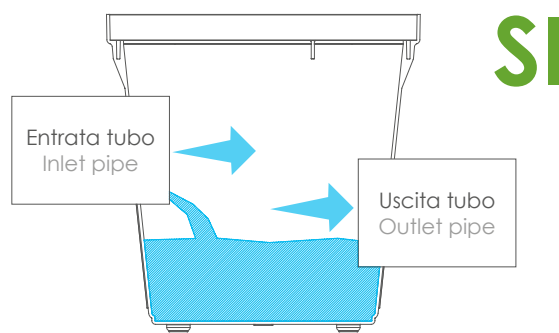
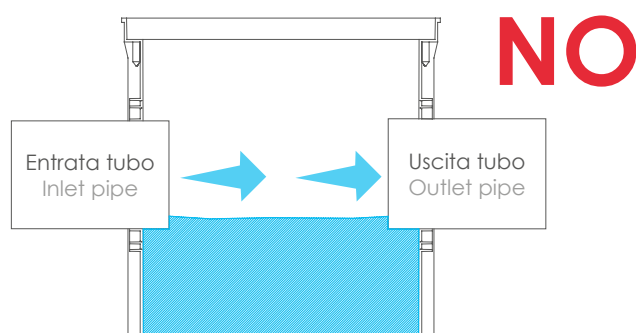

I pozzetti tradizionali con anelli permettono l'installazione di tubi idraulici soltanto in posizione allineata tra entrata e uscita, creando così un sistema errato di deflusso delle acque ed un ristagno maleodorante e poco igienico. Sui pozzetti Idrabox si possono realizzare fori in modo disassato, permettendo il corretto deflusso delle acque.

Traditional well boxes with rings allow the installation of hydraulic pipes only in an aligned position between inlet and outlet, thus creating an incorrect system of water outflow and a foul-smelling and unhygienic stagnation. Holes can be made off-center on the Idrabox wells, allowing the correct flow of water.



Installazione con tubi idraulici
Installation with hydraulic pipes



Installazione con palina di messa a terra
Installation with grounding rod



Grazie alle righe di riferimento presenti su tutti e 4 i lati del pozzetto è possibile, con una fresa a tazza, realizzare dei fori della dimensione prescelta.

Thanks to the reference lines present on all 4 sides of the well box, it is possible to make holes of any size by using a hole saw.

EASYBOX Pozzetti elettrici e idraulici
EASYBOX Electric and hydraulic well boxes



<p>Materiale base: Polipropilene Materiale coperchio: Polipropilene Temperatura d'esercizio: -15°C +90°C Tipologia: fondo chiuso pretranciato Test di prova: UNI EN 124 Conformità: CE, RoHS 2015/863/EU</p> <p>Base material: Polypropylene Cover material: Polypropylene Working temperature: -15°C +90°C Typology: precutted closed bottom Proof test: UNI EN 124 Compliance: CE, RoHS 2015/863/EU</p>						
Immagine Image	Articolo Item	Colore coperchio Cover color	Carico max Max loading	A mm	B mm	C mm
	PZC2020	Grigio Pietra Grey Stone	165 Kg	200	200	200
	PZC3030	Grigio Pietra Grey Stone	235 Kg	290	290	295
	PZC4040	Grigio Pietra Grey Stone	250 Kg	390	390	395

EASYBOX Telaio con coperchio EASYBOX Frame with cover



<p>Materiale base: Polipropilene Materiale coperchio: Polipropilene Temperatura d'esercizio: -15°C +90°C Tipologia: Telaio di contenimento Test di prova: UNI EN 124 Conformità: CE, RoHS 2015/863/EU</p> <p>Base material: Polypropylene Cover material: Polypropylene Working temperature: -15°C +90°C Typology: Containment frame Proof test: UNI EN 124 Compliance: CE, RoHS 2015/863/EU</p>						
Immagine Image	Articolo Item	Colore coperchio Cover color	Carico max Max loading	A mm	B mm	C mm
	PTL2020	Grigio Pietra Grey Stone	165 Kg	240	240	19
	PTL3030	Grigio Pietra Grey Stone	235 Kg	335	335	20

EASYBOX Accessori per pozzetti EASYBOX Accessories for well boxes



Immagine Image	Articolo Item	Materiale Material	Colore Color
	PGR2020	Guarnizione 200x200 mm in gomma SBR spessore 2 mm SBR Rubber sealing 200x200 mm thickness 2 mm	Nero Black
	PGR3030	Guarnizione 290x290 mm in gomma SBR spessore 2 mm SBR Rubber sealing 290x290 mm thickness 2 mm	Nero Black
	PGR4040	Guarnizione 390x390 mm in gomma SBR spessore 2 mm SBR Rubber sealing 390x390 mm thickness 2 mm	Nero Black
	PV4232	4 Viti in acciaio inox 4,2x32 mm per chiusura coperchio 4 Screws in stainless steel 4,2x32 mm for closing the cover	



Isopro

358

Scaricatori di sovratensione
per corrente da fulmine T1+T2
Lightning current arresters T1+T2



Enerpro

364

Scaricatori di sovratensione T2 e T3
Surge arresters T2 and T3



Ledpro

376

Scaricatori di sovratensione T3
per corpi illuminanti a LED
Surge arresters T3
for LED lighting appliances



Solarpro

377

Scaricatori di sovratensione T2 DC
per impianti fotovoltaici
Surge arresters T2 DC
for photovoltaic systems



Datapro

380

Scaricatori di sovratensione per reti ADSL, analogiche, TV, SAT, TVCC POE, Ethernet, CAT 5 e CAT 6

Surge arresters for ADSL, analog, TV, SAT, TVCC POE, Ethernet, CAT 5 e CAT 6

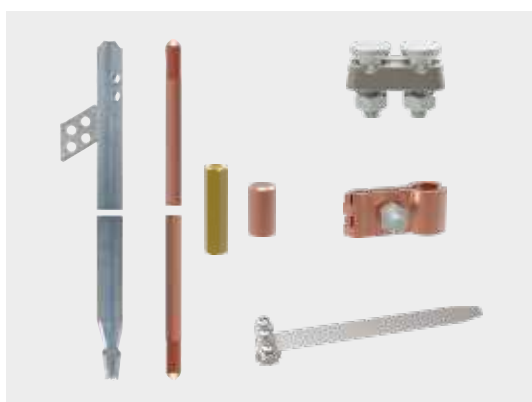

Terra

388

Componenti per impianti di messa a terra

Components for earthing systems



Bliz

396

Componenti per impianti parafulmine

Components for lightning protection systems

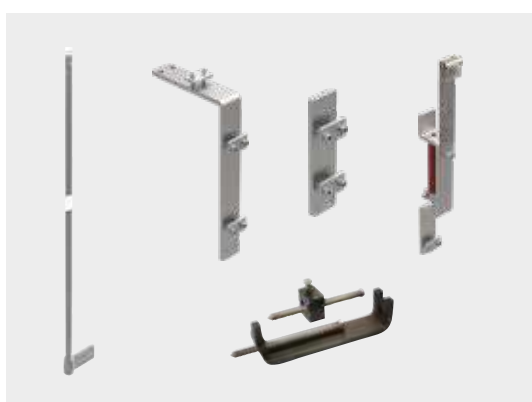

Bliz

420

Componenti speciali per impianti parafulmine

Special components for lightning protection systems

Guida introduttiva

Gli scaricatori di protezione contro le sovratensioni sono dispositivi composti da resistenze variabili quali varistori, diodi o soppressori, oppure da elementi ad innesco quali spinterometri. La loro funzione è quella di proteggere gli impianti elettrici ed i dispositivi ad essi collegati da sovratensioni molto elevate.

Possiamo distinguere gli scaricatori in base alla tipologia di impianto applicativo e più precisamente:

- **Scaricatori per impianti e apparecchi elettrici con tensione nominale fino a 1000 V secondo la norma CEI EN 61643-11-2004 (CEI 37-8) di Tipo 1/2/3-IEC 61643-1:2005/-11:2011 (classe di prova I/II/III);**
- **Scaricatori per reti informatiche ed apparecchiature ad esse collegate secondo la norma CEI EN 61643-21:2003 (CEI 37-6) DIN VDE 0845 parte 3-1 ed IEC 61643-21:2009;**
- **Scaricatori per impianti fotovoltaici con tensione continua fino a 1550 V secondo la norma EN 50539-11:2011 (scaricatori di Tipo 1/2).**

Oppure in base al potere di scarica della corrente impulsiva e all'effetto di protezione e precisamente:

- **Scaricatori per correnti da fulmine provocate da fulminazioni dirette o nelle immediate vicinanze della struttura in questione;**
- **Scaricatori contro le fulminazioni remote e le sovratensioni da scariche elettrostatiche o commutazioni, per protezione degli apparecchi finali.**

Gli scaricatori di sovratensione vengono utilizzati per garantire la continuità d'esercizio delle apparecchiature a vari livelli, dall'ambiente domestico passando per il terziario fino ad arrivare all'industria dove le perdite economiche derivanti da un fermo impianto possono essere ingenti. A tale proposito molto importante è il concetto di protezione a zone, definito nella norma CEI 81-10/4, che consente di ottenere, in base alla struttura da proteggere, l'adeguato livello di sicurezza delle apparecchiature e degli impianti. In base a questa norma l'edificio viene diviso in zone con diversi livelli di rischio (LPZ) e di conseguenza è possibile definire il livello di protezione da adottare, sia per la rete di energia sia per la rete dati. Laddove necessario è possibile che sia richiesto un impianto di protezione esterna composto da captatori, calate e messa a terra (LPS esterno), che va necessariamente integrato con l'installazione di scaricatori a partire dal Tipo 1. La tipologia del danno sugli impianti è strettamente collegata al tipo di fulminazione che può essere diretto sulla struttura o remota, ossia anche a considerevole distanza dall'impianto stesso. Le sovratensioni possono anche essere provocate da altri fattori quali manovre errate nelle cabine di distribuzione, l'innesco e l'interruzione di archi, la disinserzione di carichi induttivi. E' per questi motivi che una scelta adeguata degli scaricatori da installare garantisce una protezione efficace e duratura nel tempo a salvaguardia degli impianti siano essi civili o industriali.

Getting Started Guide

Surge protection arresters are devices made up of variable resistances such as varistors, diodes or suppressors, or trigger elements such as spark gaps. Their function is to protect electrical systems and devices connected to them from very high overvoltages.

We can distinguish the arresters based on the type of application system and more precisely:

- **Arresters for electrical systems and appliances with nominal voltage up to 1000 V according to CEI EN 61643-11-2004 (CEI 37-8) of Type 1/2/3-IEC 61643-1: 2005 / -11: 2011 (test class I / II / III);**
- **SPDs for computer networks and equipment connected to them according to the CEI EN 61643-21: 2003 (CEI 37-6) DIN VDE 0845 part 3-1 and IEC 61643-21: 2009 standards;**
- **Arresters for photovoltaic systems with direct voltage up to 1550 V according to the EN 50539-11: 2011 standard (Type 1/2 arrester).**

Or based on the discharge power of the impulse current and the protective effect, namely:

- **Arresters for lightning currents caused by direct lightning strikes or in the immediate vicinity of the structure in question;**
- **SPDs against remote lightning strikes and overvoltages from electrostatic discharges or switching, for protection of end devices.**

The surge arresters are used to ensure the continuity of operation of the equipment at various levels, from the domestic environment through the service sector to the industry where the economic losses deriving from a plant shutdown can be significant. In this regard, the concept of zone protection, defined in CEI 81-10 / 4, is very important, which allows to obtain, based on the structure to be protected, the appropriate level of safety of the equipment and systems. According to this standard, the building is divided into areas with different risk levels (LPZ) and consequently it is possible to define the level of protection to be adopted, both for the energy network and for the data network. Where necessary, it is possible that an external protection system consisting of sensors, drops and grounding (external LPS) is required, which must necessarily be integrated with the installation of arresters starting from Type 1. The type of damage to the systems is strictly connected to the type of lightning strike that can be directed on the structure or remote, i.e. also at a considerable distance from the system itself. Overvoltages can also be caused by other factors such as incorrect maneuvers in the distribution booths, the triggering and interruption of arcs, the disconnection of inductive loads. It is for these reasons that an appropriate choice of arresters to be installed guarantees effective and long-lasting protection to safeguard civil and industrial plants.



Scelta degli scaricatori

La scelta degli scaricatori da installare dipende dalla tipologia della struttura da proteggere:

- **Industria;**
- **Casa o struttura isolata o fuori da un centro abitato;**
- **Casa o struttura nel centro abitato.**

Per tutti e tre i casi va tenuto conto dell'eventuale presenza di un LPS esterno, di una linea aerea o di una linea interrata.

Dalla tipologia della rete elettrica:

- **Rete TT ossia fase+neutro o trifase+neutro;**
- **Rete TNS ossia 3 fasi+neutro distribuito;**
- **Rete TNC ossia 3 fasi+PEN.**

in base a dove va installato:

- **Quadro generale;**
- **Quadro secondario;**
- **UtENZE finali;**
- **Impianto fotovoltaico;**
- **Rete dati.**

Per una protezione efficace degli impianti è necessario un corretto coordinamento tra gli scaricatori in base al tipo di distribuzione e al tipo delle apparecchiature da proteggere. La protezione è tanto più efficace quanto più precisa è la scelta dello scaricatore da installare, partendo dal quadro generale, per passare al quadro secondario, fino ad arrivare all'utenza finale, senza trascurare le linee di segnale della rete dati, sia essa di utilizzo civile (TV, telefono, TVCC, domotica) sia industriale (automazione, macchinari, impianti di produzione). Nelle pagine seguenti potete trovare una utile guida rapida alla scelta degli scaricatori sia per l'impianto industriale che civile e terziario, per la protezione della rete di energia e della rete dati. In quanto ai costi, una scelta corretta dei prodotti da installare, risulta sicuramente sostenibile ed affidabile nel tempo ed è per questo che Arnocanali è a vostra disposizione per guidarvi e consigliarvi al meglio, qualunque sia il vostro settore di pertinenza, dalla progettazione, all'installazione, eventualmente con sopralluoghi dove necessario o con visite mirate.

Choice of arresters

The choice of arresters to be applied depends on the type of structure to be protected:

- **Industry;**
- **House or structure isolated or outside a built-up area;**
- **House or structure in the inhabited center.**

For all three cases, the possible presence of an external LPS, an overhead line or an underground line must be taken into account.

The type of electricity network:







- **TT network or phase + neutral or three-phase + neutral;**
- **TNS network or 3 phases + neutral distributed;**
- **TNC network or 3 phases + PEN.**

based on where it should be installed:

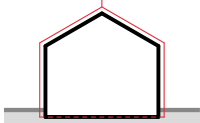
- **General electrical panel;**
- **Secondary electrical panel;**
- **End users;**
- **Photovoltaic system;**
- **Data network.**

For effective system protection, correct coordination between surge arresters is required based on the type of distribution and the type of equipment to be protected. The more effective the protection is, the more precise the choice of the component surge arresters is, starting from the general electrical panel, to switch to the secondary electrical panel, up to the end user, without neglecting the signal lines of the data network, whether it is used civil (TV, telephone, CCTV, home automation) and industrial (automation, machinery, production plants). In the following pages you can find a useful quick guide to the choice of surge arresters for both the industrial and civil and tertiary plants, for the protection of the energy and data networks. As for costs, a correct choice of the products to be supplied is certainly sustainable and reliable over time and this is why Arnocanali is available to guide and advise you best, regardless of the relevant service, the design, the whole installation, possibly with inspections where necessary or with targeted visits.

Per una corretta scelta degli SPD per il civile/terziario/industriale
For a correct choice of SPDs for the civil/tertiary/industrial sector

Identificazione Identification	Applicazione Application	Descrizione Description	Articolo Article	Foto prodotto Product picture
 Struttura dotata di impianto LPS I° e II° livello Structure equipped with LPS I° and II° level system	Quadro generale trifase General panel three-phase	Scaricatore ISOpro T1+T2 100 KA 3P+N 400V con telesegnalamento ISOpro T1+T2 surge arrester 100 KA 3P+N 400V with remote signaling	SC2440.4TF	
	Quadro generale monofase General panel single-phase	Scaricatore ISOpro T1+T2 50 KA 1P+N 230V con telesegnalamento ISOpro T1+T2 surge arrester 50 KA 1P+N 230V with remote signaling	SC2440.2TF	
 Struttura dotata di impianto LPS III° e IV° livello Structure equipped with LPS III° and IV° level system	Quadro generale trifase General panel three-phase	Scaricatore ISOpro T1+T2 50 KA 3P+N 400V con telesegnalamento ISOpro T1 +T2 surge arrester 50 KA 3P + N 400V with remote signaling	SC1440.4TSF	
	Quadro generale monofase General panel single-phase	Scaricatore ISOpro T1+T2 25 KA 1P+N 230V con telesegnalamento ISOpro T1+T2 surge arrester 25 KA 1P+N 230V with remote signaling	SC1440.2TSF	
 Struttura rurale con linea di alimentazione aerea Rural structure with line of aerial power supply	Quadro generale trifase General panel three-phase	Scaricatore ISOpro T1+T2 3P+N 400V con telesegnalamento ISOpro surge arrester T1+T2 3P+N 400V with remote signaling	SC1440.4TF	
	Quadro generale monofase General panel single-phase	Scaricatore ISOpro T1+T2 1P+N 230V con telesegnalamento ISOpro T1+T2 surge arrester 1P+N 230V with remote signaling	SC1440.2TF	
	Quadro secondario trifase Secondary panel three-phase	Scaricatore ENERpro T2 3P+N 400V con fusibile integrato e telesegnalamento ENERpro T1+T2 surge arrester 3P+N 400V with internal fuse and remote signaling	SS440.4FI	 NEW
	Quadro secondario monofase Secondary panel single-phase	Scaricatore ENERpro T2 1P+N 230V con fusibile integrato e telesegnalamento ENERpro T2 surge arrester 1P+N 230V with internal fuse and remote signaling	SS440.2FI	 NEW
 Struttura urbana con linea di alimentazione interrata Urban structure with line underground power supply	Quadro alimentazione trifase Secondary panel three-phase	Scaricatore ENERpro T2 3P+N 400V ENERpro T2 surge arrester 3P+N 400V	SS440.4TT	
	Quadro alimentazione monofase Secondary panel Power supply single phase	Scaricatore ENERpro T2 1P+N 230V ENERpro T2 surge arrester 1P+N 230V	SS440.2TT	
	Quadro alimentazione trifase Secondary panel power supply three-phase	Scaricatore ENERpro T2 3P+N 20 KA compatto ENERpro T2 surge arrester 3P+N 20 KA compact	SS440.4C	
	Quadro alimentazione monofase Secondary panel Power supply single phase	Scaricatore ENERpro T2 1P+N 20 KA compatto ENERpro T2 surge arrester 1P+N 20 KA compact	SS440.2C	

Per una corretta scelta degli SPD per protezioni finali For a correct choice of SPD for final protections

Identificazione Identification	Applicazione Application	Descrizione Description	Articolo Article	Foto prodotto Product picture
<p>Protezione utenze terminali Terminal user protection</p>	Su guida DIN On DIN rail	Scaricatore ENERpro per protezione T3 1P+N 230V ENERpro surge arrester for T3 protection 1P+N 230V	SL414.2	
	Esecuzione compatta Compact execution	Scaricatore ENERpro per protezione T3 1P+N 230V ENERpro surge arrester for T3 protection 1P+N 230V	SL414.M4	
<p>Protezione corpi illuminanti LED LED lighting protection</p>	Su morsettiera o corpo illuminante On terminal block or lighting appliances	Scaricatore LEDpro T2 LEDpro T2 surge arrester	SE416LED.300	
<p>Protezione linea telefonica Telephone line protection</p>	Linee analogiche e ADSL Analog and ADSL lines	Scaricatore DATApro per protezione telefonica a 2 fili DATApro surge arrester for 2-wire telephone protection	SN1410	
		Scaricatore DATApro per protezione telefonica a 2 fili DATApro surge arrester for 2 wires telephone protection	SN1410BOX	
<p>Protezione impianto TV/SAT TV/SAT system protection</p>	Su cavo coassiale TV On coaxial cable TV	Scaricatore DATApro per protezione TV e TV/SAT DATApro surge arrester for TV and TV/SAT protection	SN1415TS	
<p>Protezione fotovoltaico Photovoltaic protection</p>	Lato DC fino 600V DC side up to 600V	Scaricatore SOLARpro T2 Surge arrester SOLARpro T2	SF440.600	
	Lato DC fino 1.000V DC side up to 1.000V	Scaricatore SOLARpro T2 con telesegnalamento Surge arrester SOLARpro T2 with remote signaling	SF440.1000F	
	Lato DC fino 1.500V DC side up to 1.500V	Scaricatore SOLARpro T2 con telesegnalamento Surge arrester SOLARpro T2 with remote signaling	SF440.1500F	
<p>Protezione rete dati e PoE++ Data network protection and PoE ++</p>	Rete dati da 6, 12, 24, 48V Data network from 6, 12, 24, 48V	Scaricatore DATApro T1-T2 Surge arrester DATApro T1-T2	SN1410.06 SN1410.12 SN1410.24 SN1410.48	
	Impianti TVCC BNC BNC CCTV systems	Scaricatore DATApro T1-T2 Surge arrester DATApro T1-T2	SN1415BNC	
	Impianti TVCC PoE PoE CCTV systems	Scaricatore DATApro T1-T2 Surge arrester DATApro T1-T2	SN1415POE	
	Protezione ETHERNET ETHERNET protection	Scaricatore DATApro CAT5 Surge arrester DATApro CAT5	SN1415C5	
	Scaricatore DATApro CAT6 Surge arrester DATApro CAT6	SN1415C6		

ISOPRO

Classe di riferimento T1+T2 per reti TT-TN
Protection class T1+T2 for TT-TN networks

Scaricatori per corrente da fulmine ad alta prestazione da installare nella parte iniziale di reti di distribuzione in bassa tensione, per prevenire gli effetti derivanti da fenomeni atmosferici.
High performance lightning current arresters to be installed in the initial part of low voltage distributions, to prevent the resulting effects from atmospheric phenomena.



Articolo Item	Poli Poles	Telesegnalamento Remote signalling	Moduli occupati Occupied modules
SC2440.2TF	1(L-N)+1(N-PE)	SI - YES	4

Schema di principio
Principle scheme

Dati tecnici Technical data		
Reti Network		230/400V
Tensione massima continuativa AC Maximum operating voltage	Uc	255V
Corrente impulsiva da fulmine (10/350 µs) Lightning impulse current (10/350 µs)	Itotal	50 kA (totali) 50 kA (total)
Corrente impulsiva da fulmine (10/350 µs) Lightning impulse current (10/350 µs)	Iimp	25 kA (per polo) 25 kA (per pole)
Corrente nominale di scarica (8/20 µs) Nominal discharge current (8/20 µs)	In	30 kA (per polo) 30 kA (per pole)
Corrente massima di scarica (8/20 µs) Maximum discharge current (8/20 µs)	I _{max}	70 kA (per polo) 70 kA (per pole)
Energia specifica per polo (W/R) Specific energy per pole (W/R)		156 kJ/OHM
Livello di protezione voltaggio Voltage protection level	Up	1,5 kV
Max corrente di carico Max load current	IL	100A
Corrente susseguente Following current	I _f	Nessuna None
Corto circuito con protezione massima Short circuit with maximum protection	I _{sc}	50 kA
Fusibile di protezione Protection fuse		315AgG
Tensione TOV 120 minuti (L/N) TOV voltage 120 minutes (L/N)	UT	440 Vac
Tensione TOV 5 secondi (N/PE) TOV voltage 5 seconds (N/PE)	UT	335 Vac
Grado di protezione Protection degree	IP	20
Temperatura d'esercizio Range of operating temperatures		-40°C +85°C
Montaggio su guida metallica Mounting on metallic rail		DIN 35 (EN60715)
Sezioni di collegamento min/max Connection sections min/max		6/35 mm ²
Indicatore di guasto Fault indication		Verde/Rosso Green/Red
Materiale dell'involucro (termoplastico) Casing material (thermoplastic)		UL 94V0
Coppia di serraggio Tightening torque	Su istruzioni di montaggio On assembly instructions	

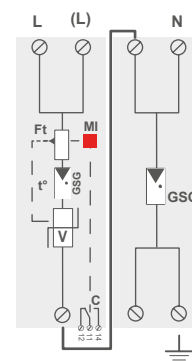

Dimensioni in mm
Dimensions in mm

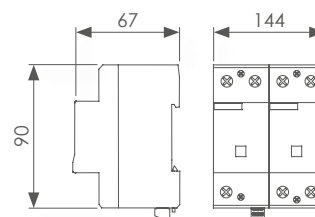

Normative di riferimento
Reference standards

EN 61643-11
IEC 61643-11
UL 1449 ed.4

ISOPRO

Classe di riferimento T1+T2 per reti TT-TN
Protection class T1+T2 for TT-TN networks

Scaricatori per corrente da fulmine ad alta prestazione da installare nella parte iniziale di reti di distribuzione in bassa tensione, per prevenire gli effetti derivanti da fenomeni atmosferici.
High performance lightning current arresters to be installed in the initial part of low voltage distributions, to prevent the resulting effects from atmospheric phenomena.



Articolo Item	Poli Poles	Telesegnalamento Remote signalling	Moduli occupati Occupied modules
SC2440.4TF	3(L-N)+1(N-PE)	SI - YES	8

Schema di principio
Principle scheme

Dati tecnici Technical data		
Reti Network		230/400V
Tensione massima continuativa AC Maximum operating voltage	Uc	255V
Corrente impulsiva da fulmine (10/350 µs) Lightning impulse current (10/350 µs)	Itotal	100 kA (totali) 100 kA (total)
Corrente impulsiva da fulmine (10/350 µs) Lightning impulse current (10/350 µs)	Iimp	25 kA (per polo) 25 kA (per pole)
Corrente nominale di scarica (8/20 µs) Nominal discharge current (8/20 µs)	In	30 kA (per polo) 30 kA (per pole)
Corrente massima di scarica (8/20 µs) Maximum discharge current (8/20 µs)	I _{max}	70 kA (per polo) 70 kA (per pole)
Energia specifica per polo (W/R) Specific energy per pole (W/R)		156 kJ/OHM
Livello di protezione voltaggio Voltage protection level	Up	1,5 kV
Max corrente di carico Max load current	IL	100A
Corrente susseguente Following current	I _f	Nessuna None
Corto circuito con protezione massima Short circuit with maximum protection	I _{sc} cr	50 kA
Fusibile di protezione Protection fuse		315AgG
Tensione TOV 120 minuti (L/N) TOV voltage 120 minutes (L/N)	UT	440 Vac
Tensione TOV 5 secondi (N/PE) TOV voltage 5 seconds (N/PE)	UT	335 Vac
Grado di protezione Protection degree	IP	20
Temperatura d'esercizio Range of operating temperatures		-40°C +85°C
Montaggio su guida metallica Mounting on metallic rail		DIN 35 (EN60715)
Sezioni di collegamento min/max Connection sections min/max		6/35 mm ²
Indicatore di guasto Fault indication		Verde/Rosso Green/Red
Materiale dell'involucro (termoplastico) Casing material (thermoplastic)		UL 94V0
Coppia di serraggio Tightening torque		Su istruzioni di montaggio On assembly instructions

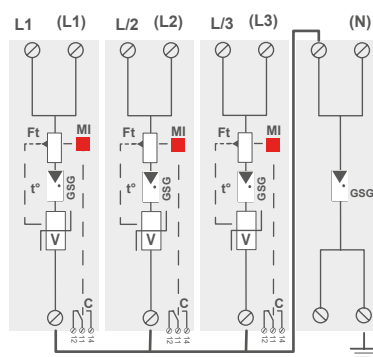

Dimensioni in mm
Dimensions in mm

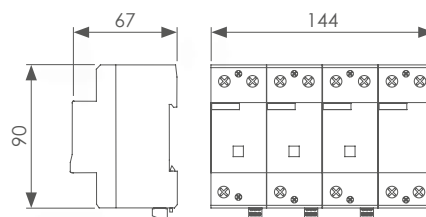

Normative di riferimento
Reference standards

EN 61643-11
IEC 61643-11
UL 1449 ed.4

ISOPRO

Classe di riferimento T1+T2 per reti TT-TN
Protection class T1+T2 for TT-TN networks

Scaricatori per corrente da fulmine ad alta prestazione da installare nella parte iniziale di reti di distribuzione in bassa tensione, per prevenire gli effetti derivanti da fenomeni atmosferici, con azzeramento della corrente residua (I_{pe}).

High performance lightning current arresters to be installed in the initial part of low voltage distributions, to prevent the resulting effects from atmospheric phenomena, with zeroing residual current (I_{pe}).

ERC CE



Articolo Item	Poli Poles	Telesegnalamento Remote signalling	Moduli occupati Occupied modules
SC1440.2TSF	1(L-N)+1(N-PE)	SI - YES	2

Schema di principio
Principle scheme

Dati tecnici Technical data		
Reti Network		230/400V
Tensione massima continuativa AC Maximum operating voltage	U _c	255V
Corrente impulsiva da fulmine (10/350 μs) Lightning impulse current (10/350 μs)	I _{total}	25 kA (totali) 25 kA (total)
Corrente impulsiva da fulmine (10/350 μs) Lightning impulse current (10/350 μs)	I _{imp}	12,5 kA (per polo) 12,5 kA (per pole)
Corrente nominale di scarica (8/20 μs) Nominal discharge current (8/20 μs)	I _n	20 kA (per polo) 20 kA (per pole)
Corrente massima di scarica (8/20 μs) Maximum discharge current (8/20 μs)	I _{max}	50 kA (per polo) 50 kA (per pole)
Energia specifica per polo (W/R) Specific energy per pole (W/R)		40 kJ/OHM
Livello di protezione voltaggio Voltage protection level	U _p	1,25 kV
Corrente residua Residual current	I _{pe}	Nessuna None
Corrente susseguente Following current	I _f	Nessuna None
Corto circuito con protezione massima Short circuit with maximum protection	I _{sc cr}	25 kA
Fusibile di protezione Protection fuse		125AgG
Tensione TOV 120 minuti (L/N) TOV voltage 120 minutes (L/N)	UT	440 Vac
Tensione TOV 5 secondi (N/PE) TOV voltage 5 seconds (N/PE)	UT	335 Vac
Grado di protezione Protection degree	IP	20
Temperatura d'esercizio Range of operating temperatures		-40°C +85°C
Montaggio su guida metallica Mounting on metallic rail		DIN 35 (EN60715)
Sezioni di collegamento min/max Connection sections min/max		2,5 - 25 mm ²
Indicatore di guasto Fault indication		Verde/Rosso Green/Red
Materiale dell'involucro (termoplastico) Casing material (thermoplastic)		UL 94V0
Coppia di serraggio Tightening torque	Su istruzioni di montaggio On assembly instructions	

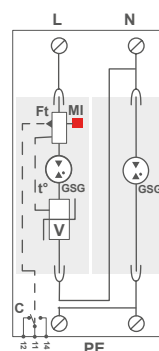

Dimensioni in mm
Dimensions in mm

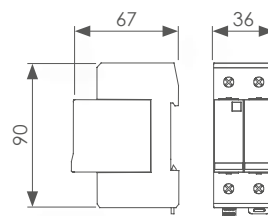

Normative di riferimento
Reference standards

EN 61643-11
IEC 61643-11
UL 1449 ed.4

Cartuccia di ricambio
Replacement cartridge



articolo - item **SC1440**

ISOPRO

Classe di riferimento T1+T2 per reti TT-TN
Protection class T1+T2 for TT-TN networks

Scaricatori per corrente da fulmine ad alta prestazione da installare nella parte iniziale di reti di distribuzione in bassa tensione, per prevenire gli effetti derivanti da fenomeni atmosferici, con azzeramento della corrente residua (I_{pe}).

High performance lightning current arresters to be installed in the initial part of low voltage distributions, to prevent the resulting effects from atmospheric phenomena, with zeroing residual current (I_{pe}).

ERC CE



Articolo Item	Poli Poles	Telesegnalamento Remote signalling	Moduli occupati Occupied modules
SC1440.4TSF	3(L-N)+1(N-PE)	SI - YES	4

Schema di principio
Principle scheme

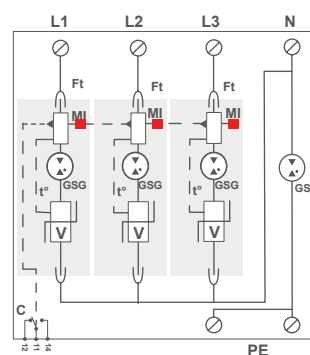

Dati tecnici Technical data		
Reti Network		230/400V
Tensione massima continuativa AC Maximum operating voltage	U _c	255V
Corrente impulsiva da fulmine (10/350 μs) Lightning impulse current (10/350 μs)	I _{total}	50 kA (totali) 50 kA (total)
Corrente impulsiva da fulmine (10/350 μs) Lightning impulse current (10/350 μs)	I _{imp}	12,5 kA (per polo) 12,5 kA (per pole)
Corrente nominale di scarica (8/20 μs) Nominal discharge current (8/20 μs)	I _n	20 kA (per polo) 20 kA (per pole)
Corrente massima di scarica (8/20 μs) Maximum discharge current (8/20 μs)	I _{max}	50 kA (per polo) 50 kA (per pole)
Energia specifica per polo (W/R) Specific energy per pole (W/R)		40 kJ/OHM
Livello di protezione voltaggio Voltage protection level	U _p	1,25 kV
Corrente residua Residual current	I _{pe}	Nessuna None
Corrente susseguente Following current	I _f	Nessuna None
Corto circuito con protezione massima Short circuit with maximum protection	I _{sc cr}	25 kA
Fusibile di protezione Protection fuse		125AgG
Tensione TOV 120 minuti (L/N) TOV voltage 120 minutes (L/N)	U _T	440 Vac
Tensione TOV 5 secondi (N/PE) TOV voltage 5 seconds (N/PE)	U _T	335 Vac
Grado di protezione Protection degree	IP	20
Temperatura d'esercizio Range of operating temperatures		-40°C +85°C
Montaggio su guida metallica Mounting on metallic rail		DIN 35 (EN60715)
Sezioni di collegamento min/max Connection sections min/max		2,5 - 25 mm ²
Indicatore di guasto Fault indication		Verde/Rosso Green/Red
Materiale dell'involucro (termoplastico) Casing material (thermoplastic)		UL 94V0
Coppia di serraggio Tightening torque	Su istruzioni di montaggio On assembly instructions	

Dimensioni in mm
Dimensions in mm

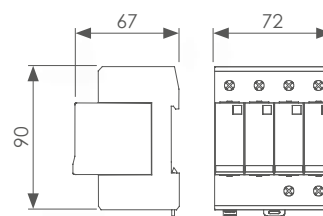

Normative di riferimento
Reference standards

EN 61643-11
IEC 61643-11
UL 1449 ed.4

Cartuccia di ricambio
Replacement cartridge



articolo - item **SC1440**

ISOPRO

Classe di riferimento T1+T2 per reti TT-TN
Protection class T1+T2 for TT-TN networks

Scaricatori per corrente da fulmine ad alta prestazione da installare nella parte iniziale di reti di distribuzione in bassa tensione, per prevenire gli effetti derivanti da fenomeni atmosferici.
High performance lightning current arresters to be installed in the initial part of low voltage distributions, to prevent the resulting effects from atmospheric phenomena.

ERC CE



Articolo Item	Poli Poles	Telesegnalamento Remote signalling	Moduli occupati Occupied modules
SC1440.2TTF	1(L-N)+1(N-PE)	SI - YES	2

Schema di principio
Principle scheme

Dati tecnici Technical data		
Reti Network		230/400V
Tensione massima continuativa AC Maximum operating voltage	Uc	255V
Corrente impulsiva da fulmine (10/350 µs) Lightning impulse current (10/350 µs)	I _{total}	25 kA (totali) 25 kA (total)
Corrente impulsiva da fulmine (10/350 µs) Lightning impulse current (10/350 µs)	I _{imp}	12,5 kA (per polo) 12,5 kA (per pole)
Corrente nominale di scarica (8/20 µs) Nominal discharge current (8/20 µs)	I _n	20 kA (per polo) 20 kA (per pole)
Corrente massima di scarica (8/20 µs) Maximum discharge current (8/20 µs)	I _{max}	50 kA (per polo) 50 kA (per pole)
Energia specifica per polo (W/R) Specific energy per pole (W/R)		40 kJ/OHM
Livello di protezione voltaggio Voltage protection level	U _p	1,3 kV
Corrente residua Residual current	I _{pe}	<1mA
Corrente susseguente Following current	I _f	Nessuna None
Corto circuito con protezione massima Short circuit with maximum protection	I _{sc cr}	25 kA
Fusibile di protezione Protection fuse		125AgG
Tensione TOV 120 minuti (L/N) TOV voltage 120 minutes (L/N)	UT	440 Vac
Tensione TOV 5 secondi (N/PE) TOV voltage 5 seconds (N/PE)	UT	335 Vac
Grado di protezione Protection degree	IP	20
Temperatura d'esercizio Range of operating temperatures		-40°C +85°C
Montaggio su guida metallica Mounting on metallic rail		DIN 35 (EN60715)
Sezioni di collegamento min/max Connection sections min/max		2,5 - 25 mm ²
Indicatore di guasto Fault indication		Verde/Rosso Green/Red
Materiale dell'involucro (termoplastico) Casing material (thermoplastic)		UL 94V0
Coppia di serraggio Tightening torque	Su istruzioni di montaggio On assembly instructions	

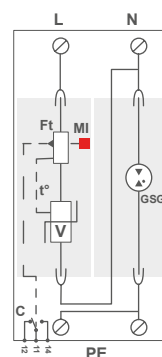

Dimensioni in mm
Dimensions in mm

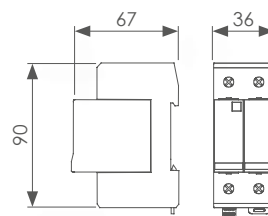

Normative di riferimento
Reference standards

EN 61643-11
IEC 61643-11
UL 1449 ed.4

Cartuccia di ricambio
Replacement cartridge



articolo - item **SC1440**

ISOPRO

Classe di riferimento T1+T2 per reti TT-TN
Protection class T1+T2 for TT-TN networks

Scaricatori per corrente da fulmine ad alta prestazione da installare nella parte iniziale di reti di distribuzione in bassa tensione, per prevenire gli effetti derivanti da fenomeni atmosferici.
High performance lightning current arresters to be installed in the initial part of low voltage distributions, to prevent the resulting effects from atmospheric phenomena.

EAC CE



Articolo Item	Poli Poles	Telesegnalamento Remote signalling	Moduli occupati Occupied modules
SC1440.4TTF	3(L-N)+1(N-PE)	SI - YES	4

Schema di principio
Principle scheme

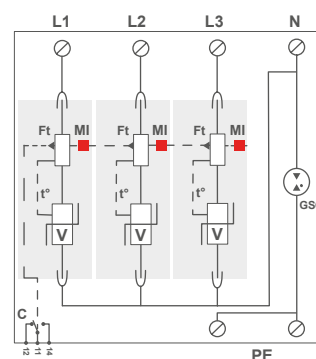

Dati tecnici Technical data		
Reti Network		230/400V
Tensione massima continuativa AC Maximum operating voltage	Uc	255V
Corrente impulsiva da fulmine (10/350 μs) Lightning impulse current (10/350 μs)	I _{total}	50 kA (totali) 50 kA (total)
Corrente impulsiva da fulmine (10/350 μs) Lightning impulse current (10/350 μs)	I _{imp}	12,5 kA (per polo) 12,5 kA (per pole)
Corrente nominale di scarica (8/20 μs) Nominal discharge current (8/20 μs)	I _n	20 kA (per polo) 20 kA (per pole)
Corrente massima di scarica (8/20 μs) Maximum discharge current (8/20 μs)	I _{max}	50 kA (per polo) 50 kA (per pole)
Energia specifica per polo (W/R) Specific energy per pole (W/R)		40 kJ/OHM
Livello di protezione voltaggio Voltage protection level	U _p	1,3 kV
Corrente residua Residual current	I _{pe}	<1mA
Corrente susseguente Following current	I _f	Nessuna None
Corto circuito con protezione massima Short circuit with maximum protection	I _{sc cr}	25 kA
Fusibile di protezione Protection fuse		125AgG
Tensione TOV 120 minuti (L/N) TOV voltage 120 minutes (L/N)	UT	440 Vac
Tensione TOV 5 secondi (N/PE) TOV voltage 5 seconds (N/PE)	UT	335 Vac
Grado di protezione Protection degree	IP	20
Temperatura d'esercizio Range of operating temperatures		-40°C +85°C
Montaggio su guida metallica Mounting on metallic rail		DIN 35 (EN60715)
Sezioni di collegamento min/max Connection sections min/max		2,5 - 25 mm ²
Indicatore di guasto Fault indication		Verde/Rosso Green/Red
Materiale dell'involucro (termoplastico) Casing material (thermoplastic)		UL 94V0
Coppia di serraggio Tightening torque	Su istruzioni di montaggio On assembly instructions	

Dimensioni in mm
Dimensions in mm

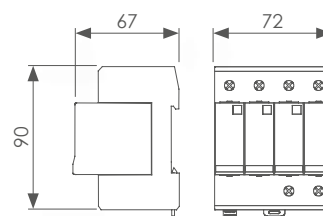

Normative di riferimento
Reference standards

EN 61643-11
IEC 61643-11
UL 1449 ed.4

Cartuccia di ricambio
Replacement cartridge



articolo - item **SC1440**

ENERPRO con fusibile integrato

Classe di protezione T2 per reti TT-TN
Protection class T2 for TT-TN networks



Scaricatore di sovratensione, da installare in quadri secondari di distribuzione in bassa tensione con fusibile integrato, per prevenire gli effetti derivanti da fenomeni atmosferici.
Overvoltage arresters with internal fuse, to be installed on secondary panel boards of low-voltage distributions, to prevent overvoltage effects induced during lightning strikes.



Articolo Item	Poli Poles	Telesegnalamento Remote signalling	Moduli occupati Occupied modules
SS440.2FI	1(L-N)+1(N-PE)	SI - YES	2

Schema di principio
Principle scheme

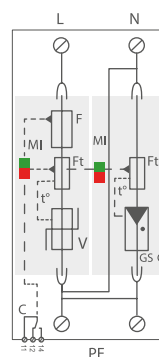

Dati tecnici Technical data		
Reti Network		230/400V
Tensione massima continuativa AC Maximum operating voltage	Uc	275V
Corrente nominale di scarica (8/20 µs) Nominal discharge current (8/20 µs)	In	15 kA
Corrente massima di scarica (8/20 µs) Maximum discharge current (8/20 µs)	I _{max}	25 kA (per polo)
Energia specifica per polo (W/R) Specific energy per pole (W/R)		40 kJ/OHM
Livello di protezione voltaggio Voltage protection level	Up	1,25 kV
Corrente residua Residual current	I _{pe}	<1mA
Corrente susseguente Following current	I _f	Nessuna None
Corto circuito con protezione massima Short circuit with maximum protection	I _{sc cr}	100 kA
Fusibile di protezione interno Internal Protection fuse		40AgG
Tensione TOV 120 minuti (L/N) TOV voltage 120 minutes (L/N)	UT	UT 440 Vac
Tensione TOV 5 secondi (N/PE) TOV voltage 5 seconds (N/PE)	UT	UT 335 Vac
Grado di protezione Protection degree	IP	20
Temperatura d'esercizio Range of operating temperatures		-40°C +85°C
Montaggio su guida metallica Mounting on metallic rail		DIN 35 (EN60715)
Sezioni di collegamento min/max Connection sections min/max		2,5 - 25 mm ² 35 mm ² Rigido/Rigid
Indicatore di guasto Fault indication		Verde/Rosso Green/Red
Materiale dell'involucro (termoplastico) Casing material (thermoplastic)		UL 94V0
Coppia di serraggio Tightening torque	Su istruzioni di montaggio On assembly instructions	

Dimensioni in mm
Dimensions in mm

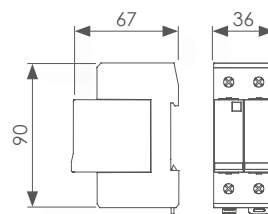

Normative di riferimento
Reference standards

EN 61643-11
IEC 61643-11
UL 1449 ed.4

Cartuccia di ricambio
Replacement cartridge



articolo - item **SS440FI**

ENERPRO con fusibile integrato

Classe di protezione T2 per reti TT-TN
Protection class T2 for TT-TN networks



Scaricatore di sovratensione con fusibile integrato, da installare in quadri secondari di distribuzione in bassa tensione, per prevenire gli effetti derivanti da fenomeni atmosferici.

Overvoltage arresters with internal fuse, to be installed on secondary panel boards of low-voltage distributions, to prevent overvoltage effects induced during lightning strikes.



Articolo Item	Poli Poles	Telesegnalamento Remote signalling	Moduli occupati Occupied modules
SS440.4FI	3(L-N)+1(N-PE)	SI - YES	4

Schema di principio
Principle scheme

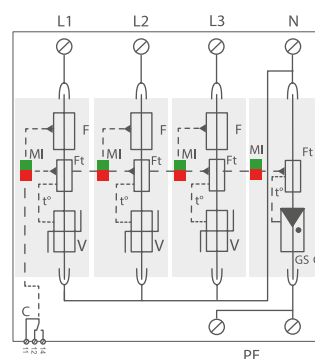

Dati tecnici Technical data		
Reti Network		230/400V
Tensione massima continuativa AC Maximum operating voltage	Uc	275V
Corrente nominale di scarica (8/20 µs) Nominal discharge current (8/20 µs)	In	15 kA
Corrente massima di scarica (8/20 µs) Maximum discharge current (8/20 µs)	I _{max}	25 kA (per polo)
Energia specifica per polo (W/R) Specific energy per pole (W/R)		40 kJ/OHM
Livello di protezione voltaggio Voltage protection level	Up	1,25 kV
Corrente residua Residual current	I _{pe}	<1mA
Corrente susseguente Following current	I _f	Nessuna None
Corto circuito con protezione massima Short circuit with maximum protection	I _{sc}	100 kA
Fusibile di protezione interno Internal Protection fuse		40AgG
Tensione TOV 120 minuti (L/N) TOV voltage 120 minutes (L/N)	UT	UT 440 Vac
Tensione TOV 5 secondi (N/PE) TOV voltage 5 seconds (N/PE)	UT	UT 335 Vac
Grado di protezione Protection degree	IP	20
Temperatura d'esercizio Range of operating temperatures		-40°C +85°C
Montaggio su guida metallica Mounting on metallic rail		DIN 35 (EN60715)
Sezioni di collegamento min/max Connection sections min/max		2,5 - 25 mm ² 35 mm ² Rigido/Rigid
Indicatore di guasto Fault indication		Verde/Rosso Green/Red
Materiale dell'involucro (termoplastico) Casing material (thermoplastic)		UL 94V0
Coppia di serraggio Tightening torque	Su istruzioni di montaggio On assembly instructions	

Dimensioni in mm
Dimensions in mm

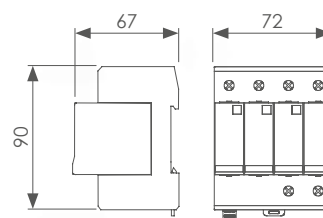

Normative di riferimento
Reference standards

EN 61643-11
IEC 61643-11
UL 1449 ed.4

Cartuccia di ricambio
Replacement cartridge



articolo - item **SS440FI**

ENERPRO

Classe di protezione T2 per reti TN
Protection class T2 for TN networks

Scaricatore di sovratensione, da installare in quadri secondari di distribuzione in bassa tensione, per prevenire gli effetti derivanti da fenomeni atmosferici.

Overvoltage arresters, to be installed on secondary panel boards of low-voltage distributions, to prevent overvoltage effects induced during lightning strikes.

Articolo Item	Poli Poles	Telesegnalamento Remote signalling	Moduli occupati Occupied modules
SS440.1	L-N	NO	1
SS440.1F	L-N	SI - YES	1
SS440.2	2 L-N	NO	2

Dati tecnici Technical data		
Reti Network		230/400V
Tensione massima continuativa AC Maximum operating voltage	Uc	255V
Corrente nominale di scarica (8/20 µs) Nominal discharge current (8/20 µs)	In	20 kA (per polo) 20 kA (per pole)
Corrente massima di scarica (8/20 µs) Maximum discharge current (8/20 µs)	I _{max}	40 kA (per polo) 40 kA (per pole)
Livello di protezione voltaggio Voltage protection level	Up	1,25 kV
Corrente residua Residual current	I _{pe}	<1mA
Corrente susseguente Following current	I _f	Nessuna None
Corto circuito con protezione massima Short circuit with maximum protection	I _{sc}	25 kA
Fusibile di protezione Protection fuse		50AgG
Tensione TOV 120 minuti (L/N) TOV voltage 120 minutes (L/N)	UT	440 Vac
Tensione TOV 5 secondi (N/PE) TOV voltage 5 seconds (N/PE)	UT	335 Vac
Grado di protezione Protection degree	IP	20
Temperatura d'esercizio Range of operating temperatures		-40°C +85°C
Montaggio su guida metallica Mounting on metallic rail		DIN 35 (EN60715)
Sezioni di collegamento min/max Connection sections min/max		2,5 - 25 mm ²
Indicatore di guasto Fault indication		Verde/Rosso Green/Red
Materiale dell'involucro (termoplastico) Casing material (thermoplastic)		UL 94V0
Coppia di serraggio Tightening torque		Su istruzioni di montaggio On assembly instructions

ERC CE



Schema di principio
Principle scheme

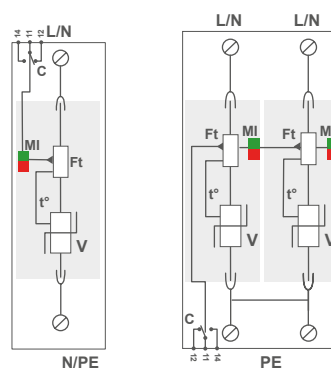

Dimensioni in mm
Dimensions in mm

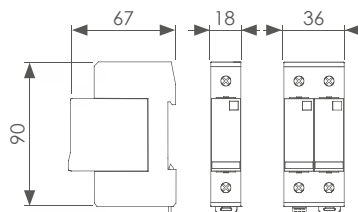

Normative di riferimento
Reference standards

EN 61643-11
IEC 61643-11
UL 1449 ed.4

Cartuccia di ricambio
Replacement cartridge



articolo - item **SS440**

Barretta di connessione in rame
Copper section rails



articolo - item **BCT351.2** 2 poli - poles
articolo - item **BCT551.3** 3 poli - poles

ENERPRO

Classe di protezione T2 per reti TNS
Protection class T2 for TNS networks

Scaricatore di sovratensione, da installare in quadri secondari di distribuzione in bassa tensione, per prevenire gli effetti derivanti da fenomeni atmosferici.

Overvoltage arresters, to be installed on secondary panel boards of low-voltage distributions, to prevent overvoltage effects induced during lightning strikes.



Articolo Item	Poli Poles	Telesegnalamento Remote signalling	Moduli occupati Occupied modules
SS440.4	4 L-N	NO	4

Dati tecnici Technical data		
Reti Network		230/400V
Tensione massima continuativa AC Maximum operating voltage	Uc	255V
Corrente nominale di scarica (8/20 µs) Nominal discharge current (8/20 µs)	In	20 kA (per polo) 20 kA (per pole)
Corrente massima di scarica (8/20 µs) Maximum discharge current (8/20 µs)	I _{max}	40 kA (per polo) 40 kA (per pole)
Livello di protezione voltaggio Voltage protection level	Up	1,25 kV
Corrente residua Residual current	I _{pe}	<1mA
Corrente susseguente Following current	I _f	Nessuna None
Corto circuito con protezione massima Short circuit with maximum protection	I _{sc}	25 kA
Fusibile di protezione Protection fuse		50AgG
Tensione TOV 120 minuti (L/N) TOV voltage 120 minutes (L/N)	UT	440 Vac
Tensione TOV 5 secondi (N/PE) TOV voltage 5 seconds (N/PE)	UT	335 Vac
Grado di protezione Protection degree	IP	20
Temperatura d'esercizio Range of operating temperatures		-40°C +85°C
Montaggio su guida metallica Mounting on metallic rail		DIN 35 (EN60715)
Sezioni di collegamento min/max Connection sections min/max		2,5 - 25 mm ²
Indicatore di guasto Fault indication		Verde/Rosso Green/Red
Materiale dell'involucro (termoplastico) Casing material (thermoplastic)		UL 94V0
Coppia di serraggio Tightening torque		Su istruzioni di montaggio On assembly instructions

Schema di principio
Principle scheme

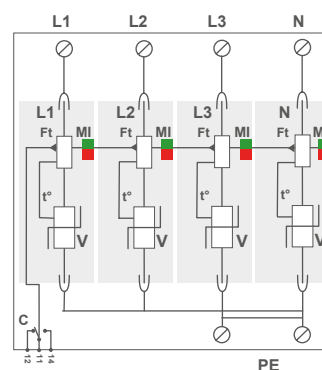

Dimensioni in mm
Dimensions in mm

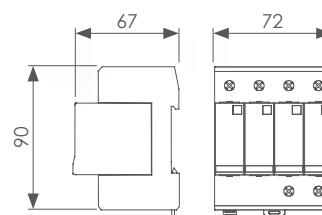

Normative di riferimento
Reference standards

EN 61643-11
IEC 61643-11
UL 1449 ed.4

Cartuccia di ricambio
Replacement cartridge



articolo - item **SS440**

ENERPRO

Classe di protezione T2 per reti TT-TN
Protection class T2 for TT-TN networks

Scaricatore di sovratensione, da installare in quadri secondari di distribuzione in bassa tensione, per prevenire gli effetti derivanti da fenomeni atmosferici.

Overvoltage arresters, to be installed on secondary panel boards of low-voltage distributions, to prevent overvoltage effects induced during lightning strikes.



Articolo Item	Poli Poles	Telesegnalamento Remote signalling	Moduli occupati Occupied modules
SS440.2TT	1(L-N)+1(N-PE)	NO	2
SS440.2TTF	1(L-N)+1(N-PE)	SI - YES	2

Schema di principio
Principle scheme

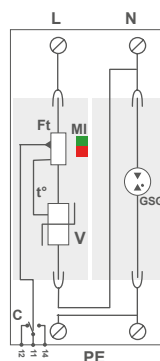

Dati tecnici Technical data		
Reti Network		230/400V
Tensione massima continuativa AC Maximum operating voltage	Uc	255V
Corrente nominale di scarica (8/20 μs) Nominal discharge current (8/20 μs)	In	20 kA (per polo) 20 kA (per pole)
Corrente massima di scarica (8/20 μs) Maximum discharge current (8/20 μs)	I _{max}	40 kA (per polo) 40 kA (per pole)
Livello di protezione voltaggio Voltage protection level	Up	1,25 kV
Corrente residua Residual current	I _{pe}	<1mA
Corrente susseguente Following current	I _f	Nessuna None
Corto circuito con protezione massima Short circuit with maximum protection	I _{sc}	25 kA
Fusibile di protezione Protection fuse		50AgG
Tensione TOV 120 minuti (L/N) TOV voltage 120 minutes (L/N)	UT	440 Vac
Tensione TOV 5 secondi (N/PE) TOV voltage 5 seconds (N/PE)	UT	335 Vac
Grado di protezione Protection degree	IP	20
Temperatura d'esercizio Range of operating temperatures		-40°C +85°C
Montaggio su guida metallica Mounting on metallic rail		DIN 35 (EN60715)
Sezioni di collegamento min/max Connection sections min/max		2,5 - 25 mm ²
Indicatore di guasto Fault indication		Verde/Rosso Green/Red
Materiale dell'involucro (termoplastico) Casing material (thermoplastic)		UL 94V0
Coppia di serraggio Tightening torque	Su istruzioni di montaggio On assembly instructions	

Dimensioni in mm
Dimensions in mm

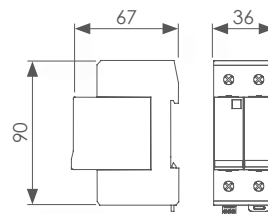

Normative di riferimento
Reference standards

EN 61643-11
IEC 61643-11
UL 1449 ed.4

Cartuccia di ricambio
Replacement cartridge



articolo - item **SS440**
articolo - item **SS440TT**

ENERPRO

Classe di protezione T2 per reti TT-TN
Protection class T2 for TT-TN networks

Scaricatore di sovratensione, da installare in quadri secondari di distribuzione in bassa tensione, per prevenire gli effetti derivanti da fenomeni atmosferici.

Overvoltage arresters, to be installed on secondary panel boards of low-voltage distributions, to prevent overvoltage effects induced during lightning strikes.



Articolo Item	Poli Poles	Telesegnalamento Remote signalling	Moduli occupati Occupied modules
SS440.4TT	3(L-N)+1(N-PE)	NO	4
SS440.4TTF	3(L-N)+1(N-PE)	SI - YES	4

Schema di principio
Principle scheme

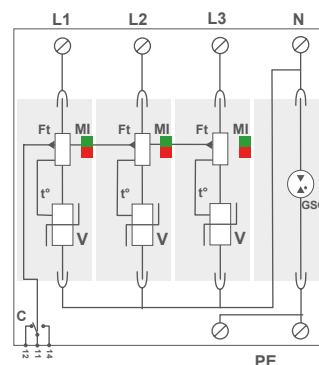

Dati tecnici Technical data		
Reti Network		230/400V
Tensione massima continuativa AC Maximum operating voltage	Uc	255V
Corrente nominale di scarica (8/20 μs) Nominal discharge current (8/20 μs)	In	20 kA (per polo) 20 kA (per pole)
Corrente massima di scarica (8/20 μs) Maximum discharge current (8/20 μs)	I _{max}	40 kA (per polo) 40 kA (per pole)
Livello di protezione voltaggio Voltage protection level	Up	1,25 kV
Corrente residua Residual current	I _{pe}	<1mA
Corrente susseguente Following current	I _f	Nessuna None
Corto circuito con protezione massima Short circuit with maximum protection	I _{sc}	25 kA
Fusibile di protezione Protection fuse		50AgG
Tensione TOV 120 minuti (L/N) TOV voltage 120 minutes (L/N)	UT	440 Vac
Tensione TOV 5 secondi (N/PE) TOV voltage 5 seconds (N/PE)	UT	335 Vac
Grado di protezione Protection degree	IP	20
Temperatura d'esercizio Range of operating temperatures		-40°C +85°C
Montaggio su guida metallica Mounting on metallic rail		DIN 35 (EN60715)
Sezioni di collegamento min/max Connection sections min/max		2,5 - 25 mm ²
Indicatore di guasto Fault indication		Verde/Rosso Green/Red
Materiale dell'involucro (termoplastico) Casing material (thermoplastic)		UL 94V0
Coppia di serraggio Tightening torque	Su istruzioni di montaggio On assembly instructions	

Dimensioni in mm
Dimensions in mm

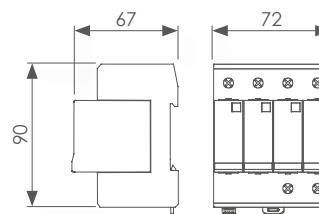

Normative di riferimento
Reference standards

EN 61643-11
IEC 61643-11
UL 1449 ed.4

Cartuccia di ricambio
Replacement cartridge



articolo - item **SS440**
articolo - item **SS440TT**

ENERPRO - Compatto

Classe di protezione T2 per reti TT-TN
Protection class T2 for TT-TN networks

Scaricatore di sovratensione compatto, da installare in quadri secondari di distribuzione in bassa tensione, per prevenire gli effetti derivanti da fenomeni atmosferici.

Compact overvoltage arresters, to be installed on secondary panel boards of low-voltage distributions, to prevent overvoltage effects induced during lightning strikes.



Articolo Item	Poli Poles	Telesegnalamento Remote signalling	Moduli occupati Occupied modules
SS440.2C	1(L-N)+1(N-PE)	NO	1

Schema di principio
Principle scheme

Dati tecnici Technical data		
Reti Network		230/400V
Tensione massima continuativa AC Maximum operating voltage	Uc	255V
Corrente nominale di scarica (8/20 µs) Nominal discharge current (8/20 µs)	In	20 kA (per polo) 20 kA (per pole)
Corrente massima di scarica (8/20 µs) Maximum discharge current (8/20 µs)	I _{max}	40 kA (per polo) 40 kA (per pole)
Max corrente di carico Max load current	I _L	20A
Livello di protezione voltaggio Voltage protection level	U _p	1,5/1,25 kV
Corrente residua Residual current	I _{pe}	Nessuna None
Corrente susseguente Following current	I _f	Nessuna None
Corto circuito con protezione massima Short circuit with maximum protection	I _{sc cr}	25 kA
Fusibile di protezione Protection fuse		50AgG
Tensione TOV 120 minuti (L/N) TOV voltage 120 minutes (L/N)	UT	440 Vac
Tensione TOV 5 secondi (N/PE) TOV voltage 5 seconds (N/PE)	UT	335 Vac
Grado di protezione Protection degree	IP	20
Temperatura d'esercizio Range of operating temperatures		-40°C +85°C
Montaggio su guida metallica Mounting on metallic rail		DIN 35 (EN60715)
Sezioni di collegamento min/max Connection sections min/max		1,5 - 10 mm ² (L-N) 2,5 - 25 mm ² (N-PE)
Indicatore di guasto Fault indication		Verde/Rosso Green/Red
Materiale dell'involucro (termoplastico) Casing material (thermoplastic)		UL 94V0
Coppia di serraggio Tightening torque	Su istruzioni di montaggio On assembly instructions	

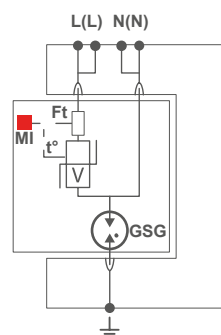

Dimensioni in mm
Dimensions in mm

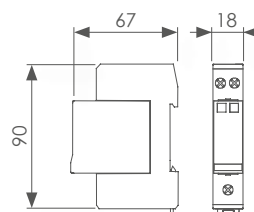

Normative di riferimento
Reference standards

EN 61643-11
IEC 61643-11
UL 1449 ed.4

ENERPRO - Compatto

Classe di protezione T2 per reti TT-TN
Protection class T2 for TT-TN networks

Scaricatore di sovratensione compatto, da installare in quadri secondari di distribuzione in bassa tensione, per prevenire gli effetti derivanti da fenomeni atmosferici.

Compact overvoltage arresters, to be installed on secondary panel boards of low-voltage distributions, to prevent overvoltage effects induced during lightning strikes.

EAC CE



Articolo Item	Poli Poles	Telesegnalamento Remote signalling	Moduli occupati Occupied modules
SS440.4C	3(L-N)+1(N-PE)	NO	2

Schema di principio
Principle scheme

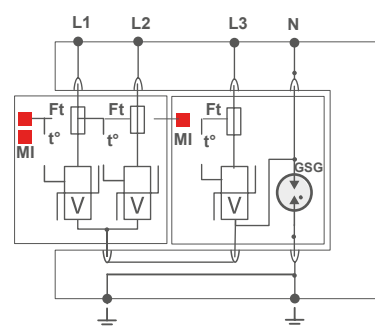

Dati tecnici Technical data		
Reti Network		230/400V
Tensione massima continuativa AC Maximum operating voltage	Uc	255V
Corrente nominale di scarica (8/20 μs) Nominal discharge current (8/20 μs)	In	20 kA (per polo) 20 kA (per pole)
Corrente massima di scarica (8/20 μs) Maximum discharge current (8/20 μs)	I _{max}	40 kA (per polo) 40 kA (per pole)
Livello di protezione voltaggio Voltage protection level	Up	1,5/1,25 kV
Corrente residua Residual current	I _{pe}	Nessuna None
Corrente susseguente Following current	I _f	Nessuna None
Corto circuito con protezione massima Short circuit with maximum protection	I _{sc}	25 kA
Fusibile di protezione Protection fuse		50AgG
Tensione TOV 120 minuti (L/N) TOV voltage 120 minutes (L/N)	UT	440 Vac
Tensione TOV 5 secondi (N/PE) TOV voltage 5 seconds (N/PE)	UT	335 Vac
Grado di protezione Protection degree	IP	20
Temperatura d'esercizio Range of operating temperatures		-40°C +85°C
Montaggio su guida metallica Mounting on metallic rail		DIN 35 (EN60715)
Sezioni di collegamento min/max Connection sections min/max		1,5 - 10 mm ² (L-N) 2,5 - 25 mm ² (N-PE)
Indicatore di guasto Fault indication		Verde/Rosso Green/Red
Materiale dell'involucro (termoplastico) Casing material (thermoplastic)		UL 94V0
Coppia di serraggio Tightening torque		Su istruzioni di montaggio On assembly instructions

Dimensioni in mm
Dimensions in mm

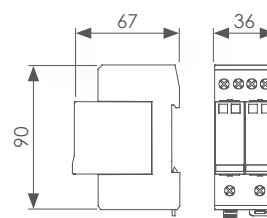

Normative di riferimento
Reference standards

EN 61643-11
IEC 61643-11
UL 1449 ed.4

ENERPRO - Compatto 5 kA

Classe di protezione T2 per reti TT-TN
Protection class T2 for TT-TN networks

Scaricatore di sovratensione compatto, da installare in quadri secondari di distribuzione in bassa tensione, per prevenire gli effetti derivanti da fenomeni atmosferici.

Compact overvoltage arresters, to be installed on secondary panel boards of low-voltage distributions, to prevent overvoltage effects induced during lightning strikes.

EAC c  CE



Articolo Item	Poli Poles	Telesegnalamento Remote signalling	Moduli occupati Occupied modules
SS445.2C	1(L-N)+1(N-PE)	NO	1

Schema di principio
Principle scheme

Dati tecnici Technical data		
Reti Network		230/400V
Tensione massima continuativa AC Maximum operating voltage	Uc	255V
Corrente nominale di scarica (8/20 µs) Nominal discharge current (8/20 µs)	In	5 kA (per polo) 5 kA (per pole)
Corrente massima di scarica (8/20 µs) Maximum discharge current (8/20 µs)	I _{max}	15 kA (per polo) 15 kA (per pole)
Max corrente di carico Max load current	IL	20A
Livello di protezione voltaggio Voltage protection level	Up	1,5/0,9 kV
Corrente residua Residual current	I _{pe}	Nessuna None
Corrente susseguente Following current	I _f	Nessuna None
Corto circuito con protezione massima Short circuit with maximum protection	I _{sc cr}	10 kA
Fusibile di protezione Protection fuse		20AgG
Tensione TOV 120 minuti (L/N) TOV voltage 120 minutes (L/N)	UT	440 Vac
Tensione TOV 5 secondi (N/PE) TOV voltage 5 seconds (N/PE)	UT	335 Vac
Grado di protezione Protection degree	IP	20
Temperatura d'esercizio Range of operating temperatures		-40°C +85°C
Montaggio su guida metallica Mounting on metallic rail		DIN 35 (EN60715)
Sezioni di collegamento min/max Connection sections min/max		1,5 - 10 mm ² (L-N) 2,5 - 25 mm ² (N-PE)
Indicatore di guasto Fault indication		Verde/Rosso Green/Red
Materiale dell'involucro (termoplastico) Casing material (thermoplastic)		UL 94V0
Coppia di serraggio Tightening torque	Su istruzioni di montaggio On assembly instructions	

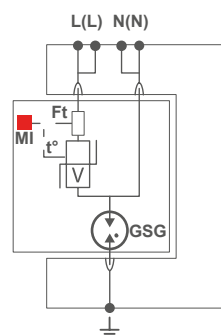

Dimensioni in mm
Dimensions in mm

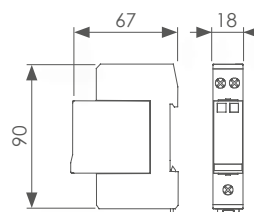

Normative di riferimento
Reference standards

EN 61643-11
IEC 61643-11
UL 1449 ed.4

ENERPRO - Compatto 5 kA

Classe di protezione T2 per reti TT-TN

Protection class T2 for TT-TN networks

Scaricatore di sovratensione compatto, da installare in quadri secondari di distribuzione in bassa tensione, per prevenire gli effetti derivanti da fenomeni atmosferici.

Compact overvoltage arresters, to be installed on secondary panel boards of low-voltage distributions, to prevent overvoltage effects induced during lightning strikes.

EAC CE



Schema di principio
Principle scheme

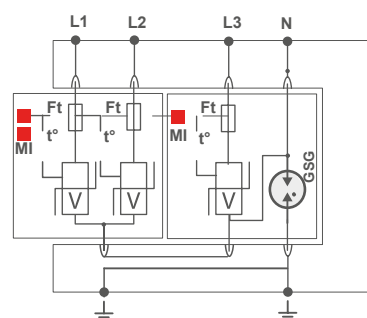

Dimensioni in mm
Dimensions in mm

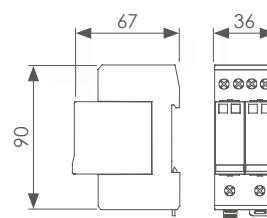

Normative di riferimento
Reference standards

EN 61643-11
IEC 61643-11
UL 1449 ed.4

Articolo Item	Poli Poles	Telesegnalamento Remote signalling	Moduli occupati Occupied modules
SS445.4C	3(L-N)+1(N-PE)	NO	2

Dati tecnici Technical data		
Reti Network		230/400V
Tensione massima continuativa AC Maximum operating voltage	Uc	255V
Corrente nominale di scarica (8/20 µs) Nominal discharge current (8/20 µs)	In	5 kA (per polo) 5 kA (per pole)
Corrente massima di scarica (8/20 µs) Maximum discharge current (8/20 µs)	I _{max}	15 kA (per polo) 15 kA (per pole)
Livello di protezione voltaggio Voltage protection level	Up	1,5/0,9 kV
Corrente residua Residual current	I _{pe}	Nessuna None
Corrente susseguente Following current	I _f	Nessuna None
Corto circuito con protezione massima Short circuit with maximum protection	I _{sc}	10 kA
Fusibile di protezione Protection fuse		20AgG
Tensione TOV 120 minuti (L/N) TOV voltage 120 minutes (L/N)	UT	440 Vac
Tensione TOV 5 secondi (N/PE) TOV voltage 5 seconds (N/PE)	UT	335 Vac
Grado di protezione Protection degree	IP	20
Temperatura d'esercizio Range of operating temperatures		-40°C +85°C
Montaggio su guida metallica Mounting on metallic rail		DIN 35 (EN60715)
Sezioni di collegamento min/max Connection sections min/max		1,5 - 10 mm ² (L-N) 2,5 - 25 mm ² (N-PE)
Indicatore di guasto Fault indication		Verde/Rosso Green/Red
Materiale dell'involucro (termoplastico) Casing material (thermoplastic)		UL 94V0
Coppia di serraggio Tightening torque		Su istruzioni di montaggio On assembly instructions

ENERPRO

Classe di protezione T3 per reti TT-TN
Protection class T3 for TT-TN networks

Scaricatore di sovratensione per la protezione di apparecchiature elettriche ed elettroniche finali collegate ad una distribuzione in bassa tensione.

Surge arrester for the protection of final electrical and electronic equipment connected to a low voltage distribution.

EAC CE



Schema di principio
Principle scheme

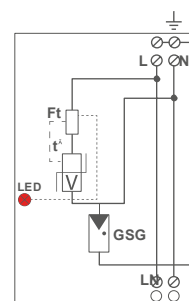

Dimensioni in mm
Dimensions in mm

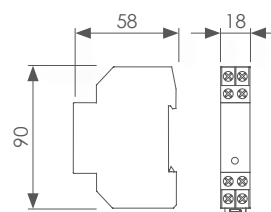

Normative di riferimento
Reference standards

EN 61643-11
IEC 61643-11
UL 1449 ed.4

Articolo Item	Poli Poles	Telesegnalamento Remote signalling	Moduli occupati Occupied modules
SL414.2	L-N/PE	NO	1

Dati tecnici Technical data		
Reti Network		230V
Tensione massima continuativa AC Maximum operating voltage	Uc	275V
Corrente nominale di scarica (8/20 µs) Nominal discharge current (8/20 µs)	In	5 kA (per polo) 5 kA (per pole)
Corrente massima di scarica (8/20 µs) Maximum discharge current (8/20 µs)	I _{max}	10 kA (per polo) 10 kA (per pole)
Max corrente di carico Max load current	IL	16A
Livello di protezione voltaggio Voltage protection level	Up	1,5 kV
Corrente residua Residual current	I _{pe}	Nessuna None
Corrente susseguente Following current	I _f	Nessuna None
Corto circuito con protezione massima Short circuit with maximum protection	I _{sc cr}	10 kA
Fusibile di protezione Protection fuse		20AgG
Tensione TOV 120 minuti (L/N) TOV voltage 120 minutes (L/N)	UT	440 Vac
Tensione TOV 5 secondi (N/PE) TOV voltage 5 seconds (N/PE)	UT	335 Vac
Grado di protezione Protection degree	IP	20
Temperatura d'esercizio Range of operating temperatures		-40°C +85°C
Montaggio su guida metallica Mounting on metallic rail		DIN 35 (EN60715)
Sezioni di collegamento min/max Connection sections min/max		2,5 - 25 mm ²
Indicatore di guasto Fault indication		Verde/Rosso Green/Red
Materiale dell'involucro (termoplastico) Casing material (thermoplastic)		UL 94V0
Coppia di serraggio Tightening torque	Su istruzioni di montaggio On assembly instructions	

ENERPRO

Classe di protezione T3 per reti TT-TN
Protection class T3 for TT-TN networks

Scaricatore di sovratensione per la protezione di apparecchiature elettriche ed elettroniche finali collegate ad una distribuzione in bassa tensione.

Surge arrester for the protection of final electrical and electronic equipment connected to a low voltage distribution.

EAC CE



Articolo Item	Poli Poles	Telesegnalamento Remote signalling	Moduli occupati Occupied modules
SL414M4	-	SONORO SOUND	-

Schema di principio
Principle scheme

Dati tecnici Technical data		
Reti Network		230V
Tensione massima continuativa AC Maximum operating voltage	Uc	255V
Corrente nominale di scarica (8/20 μs) Nominal discharge current (8/20 μs)	In	3 kA (per polo) 3 kA (per pole)
Corrente massima di scarica (8/20 μs) Maximum discharge current (8/20 μs)	I _{max}	6 kA (per polo) 6 kA (per pole)
Livello di protezione voltaggio Voltage protection level	Up	1,5/1 kV
Corrente residua Residual current	I _{pe}	Nessuna None
Resistenza alla forma d'onda Withstand on combination waveform	Voc	6 kV
Corto circuito con protezione massima Short circuit with maximum protection	I _{sc}	3 kA
Tensione TOV 120 minuti (L/N) TOV voltage 120 minutes (L/N)	UT	440 Vac
Tensione TOV 5 secondi (N/PE) TOV voltage 5 seconds (N/PE)	UT	335 Vac
Grado di protezione Protection degree	IP	20
Temperatura d'esercizio Range of operating temperatures		-40°C +85°C
Montaggio all'interno della presa Mounting inside the socket		
Sezioni di collegamento min/max Connection sections min/max		Precablato Pre-wired
Indicatore di guasto Fault indication		Cicalino Buzzer
Materiale dell'involucro (termoplastico) Casing material (thermoplastic)		UL 94V0

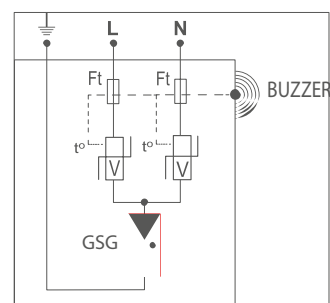

Dimensioni in mm
Dimensions in mm

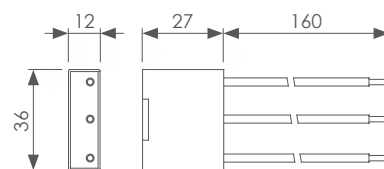

Normative di riferimento
Reference standards

EN 61643-11
IEC 61643-11
UL 1449 ed.4

LEDPRO - Protezione LED

Classe di protezione T3

Protection T3 class

Scaricatore di sovratensione per la protezione di corpi illuminanti a LED per prevenire gli effetti derivanti da fenomeni atmosferici.

Combined surge arrester for the protection of LED lighting appliances to prevent overvoltage effects during lightning strikes.

EAC CE



Articolo Item	Poli Poles	Telesegnalamento Remote signalling	Moduli occupati Occupied modules
SE416LED.300	-	NO	-

Schema di principio
Principle scheme

Dati tecnici Technical data		
Tensione nominale Nominal voltage	Un	230/277V
Tensione massima continuativa AC Maximum operating voltage	Uc	320V
Corrente nominale di scarica (8/20 µs) Nominal discharge current (8/20 µs)	In	5 kA 5 kA
Corrente massima di scarica (8/20 µs) Maximum discharge current (8/20 µs)	Imax	10 kA 10 kA
Corrente totale massima di scarica (8/20 µs) Maximum total discharge current (8/20 µs)	Itotal	20 kA 20 kA
Max corrente di carico Max load current	IL	10A
Livello di protezione voltaggio Voltage protection level	Up	1,5 kV
Resistenza alla forma d'onda Withstand on combination waveform	Voc	10 kV
Corto circuito con protezione massima Short circuit with maximum protection	Iscrr	10 kA
Corrente residua Residual current	Ipe	Nessuna None
Tensione TOV 120 minuti (L/N) TOV voltage 120 minutes (L/N)	UT	440 Vac
Tensione TOV 5 secondi (N/PE) TOV voltage 5 seconds (N/PE)	UT	335 Vac
Grado di protezione Protection degree	IP	67
Temperatura d'esercizio Range of operating temperatures		-40°C +85°C
Montaggio Mounting		A parete / libero On wall / free
Sezioni di collegamento min/max Connection sections min/max		Precablato Pre-wired
Indicatore di guasto Fault indication		Spegnimento Led Led off
Materiale dell'involucro (termoplastico) Casing material (thermoplastic)		UL 94V0

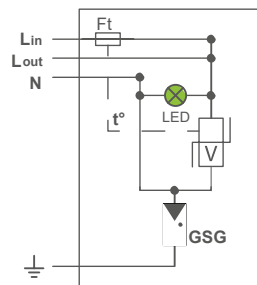

Dimensioni in mm
Dimensions in mm

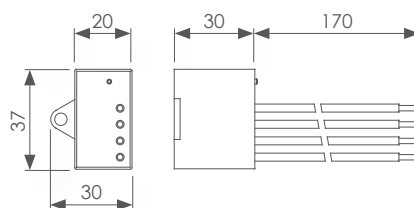

Normative di riferimento
Reference standards

EN 61643-11
IEC 61643-11
UL 1449 ed.4

EAC CE



SOLARPRO - Fotovoltaico

Classe di protezione T2 DC

Protection class T2 DC

Scaricatori di sovratensione da installare a protezione di circuiti in corrente continua di impianti FOTOVOLTAICI, per prevenire gli effetti derivanti da fenomeni atmosferici.

Surge arresters to be installed for protecting direct current circuits of PHOTOVOLTAIC systems and preventing overvoltage effects during lightning strikes.

Schema di principio
Principle scheme

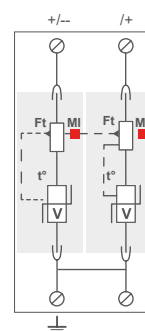

Dimensioni in mm
Dimensions in mm

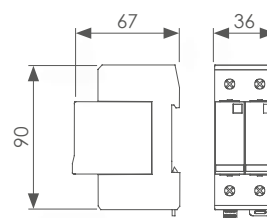

Normative di riferimento
Reference standards

EN 61643-11
IEC 61643-11
UL 1449 ed.4

Articolo Item	Poli Poles	Telesegnalamento Remote signalling	Moduli occupati Occupied modules
SF440.600	+/-/PE	NO	2

Dati tecnici Technical data		
Reti Network		PV 600V DC
Tensione massima operativa Maximum operating voltage	Ucpv	720V DC
Corrente nominale di scarica (8/20 µs) Nominal discharge current (8/20 µs)	In	15 kA (per polo) 15 kA (per pole)
Corrente massima di scarica (8/20 µs) Maximum discharge current (8/20 µs)	I _{max}	40 kA (per polo) 40 kA (per pole)
Corrente massima di scarica Maximum discharge current	I _{total}	60 kA
Livello di protezione voltaggio Voltage protection level	Up	2,8 kV
Corrente residua Residual current	I _{pe}	< 0,1 mA
Resistenza alla corrente di corto circuito Following current	I _{scpv}	15 kA
Fusibile di protezione Protection fuse		Senza fusibile No fuse
Grado di protezione Protection degree	IP	20
Temperatura d'esercizio Range of operating temperatures		-40°C +85°C
Montaggio su guida metallica Mounting on metallic rail		DIN 35 (EN60715)
Sezioni di collegamento min/max Connection sections min/max		2,5 - 25 mm ²
Indicatore di guasto Fault indication		Verde/Rosso Green/Red
Materiale dell'involucro (termoplastico) Casing material (thermoplastic)		UL 94V0
Coppia di serraggio Tightening torque		Su istruzioni di montaggio On assembly instructions

SOLARPRO - Fotovoltaico

Classe di protezione T2 DC

Protection class T2 DC

Scaricatori di sovratensione da installare a protezione di circuiti in corrente continua di impianti FOTOVOLTAICI, per prevenire gli effetti derivanti da fenomeni atmosferici.

Surge arresters to be installed for protecting direct current circuits of PHOTOVOLTAIC systems and preventing overvoltage effects during lightning strikes.



Articolo Item	Poli Poles	Telesegnalamento Remote signalling	Moduli occupati Occupied modules
SF440.1000	+/-/PE	NO	3
SF440.1000F	+/-/PE	SI - YES	3

Schema di principio
Principle scheme

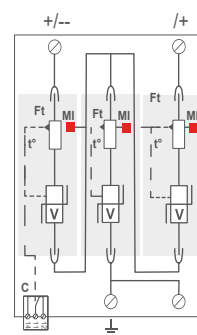

Dati tecnici Technical data		
Reti Network		PV 1000V DC
Tensione massima operativa Maximum operating voltage	Ucpv	1200V DC
Corrente nominale di scarica (8/20 µs) Nominal discharge current (8/20 µs)	In	15 kA (per polo) 15 kA (per pole)
Corrente massima di scarica (8/20 µs) Maximum discharge current (8/20 µs)	Imax	40 kA (per polo) 40 kA (per pole)
Corrente massima di scarica Maximum discharge current	Itotal	60 kA
Livello di protezione voltaggio Voltage protection level	Up	2,6/4,6 kV
Corrente residua Residual current	Ipe	Nessuna None
Resistenza alla corrente di corto circuito Following current	Iscpv	15 kA
Fusibile di protezione Protection fuse		Senza fusibile No fuse
Grado di protezione Protection degree	IP	20
Temperatura d'esercizio Range of operating temperatures		-40°C +85°C
Montaggio su guida metallica Mounting on metallic rail		DIN 35 (EN60715)
Sezioni di collegamento min/max Connection sections min/max		2,5 - 25 mm ²
Indicatore di guasto Fault indication		Verde/Rosso Green/Red
Materiale dell'involucro (termoplastico) Casing material (thermoplastic)		UL 94V0
Coppia di serraggio Tightening torque		Su istruzioni di montaggio On assembly instructions

Dimensioni in mm
Dimensions in mm

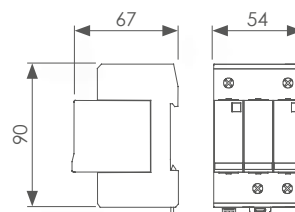

Normative di riferimento
Reference standards

EN 61643-11
IEC 61643-11
UL 1449 ed.4

SOLARPRO - Fotovoltaico

Classe di protezione T2 DC

Protection class T2 DC

Scaricatori di sovratensione da installare a protezione di circuiti in corrente continua di impianti FOTOVOLTAICI, per prevenire gli effetti derivanti da fenomeni atmosferici.

Surge arresters to be installed for protecting direct current circuits of PHOTOVOLTAIC systems and preventing overvoltage effects during lightning strikes.

EAC CE



Articolo Item	Poli Poles	Telesegnalamento Remote signalling	Moduli occupati Occupied modules
SF440.1500F	+/-/PE	SI - YES	3

Schema di principio
Principle scheme

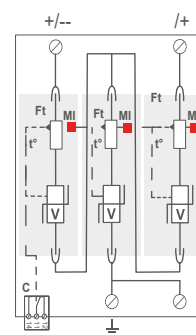

Dati tecnici Technical data		
Reti Network		PV 1250V DC
Tensione massima operativa Maximum operating voltage	Ucpv	1500V DC
Corrente nominale di scarica (8/20 µs) Nominal discharge current (8/20 µs)	In	15 kA (per polo) 15 kA (per pole)
Corrente massima di scarica (8/20 µs) Maximum discharge current (8/20 µs)	I _{max}	40 kA (per polo) 40 kA (per pole)
Corrente totale massima di scarica (8/20 µs) Maximum total discharge current (8/20 µs)	I _{total}	60 kA
Livello di protezione voltaggio Voltage protection level	Up	3,4/6,8 kV
Corrente residua Residual current	I _{pe}	Nessuna None
Resistenza alla corrente di corto circuito Following current	I _{scpv}	15 kA
Fusibile di protezione Protection fuse		Senza fusibile No fuse
Grado di protezione Protection degree	IP	20
Temperatura d'esercizio Range of operating temperatures		-40°C +85°C
Montaggio su guida metallica Mounting on metallic rail		DIN 35 (EN60715)
Sezioni di collegamento min/max Connection sections min/max		2,5 - 25 mm ²
Indicatore di guasto Fault indication		Verde/Rosso Green/Red
Materiale dell'involucro (termoplastico) Casing material (thermoplastic)		UL 94V0
Coppia di serraggio Tightening torque		Su istruzioni di montaggio On assembly instructions

Dimensioni in mm
Dimensions in mm

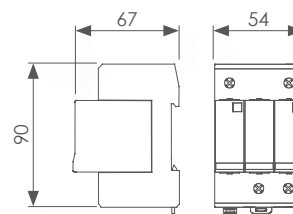

Normative di riferimento
Reference standards

EN 61643-11
IEC 61643-11
UL 1449 ed.4

DATAPRO

Classe di protezione T1+T2 per reti ADSL e ANALOGICHE
Protection class T1+T2 for ADSL and ANALOG networks

Scaricatore di sovratensione combinato per la protezione di impianti telefonici ANALOGICI, ADSL, ISDN - VDSL2 per 1 coppia di fili.

Combined surge arrester for the protection of ANALOG, ADSL, ISDN - VDSL2 for 1 couple of wires



NEW



Articolo Item	Poli Poles	Telesegnalamento Remote signalling	Moduli occupati Occupied modules
SN1410BOX	-	NO	-

Schema di principio
Principle scheme

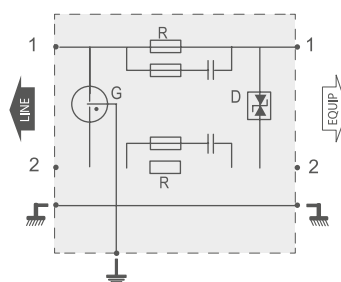

Dati tecnici Technical data		
Tensione nominale Nominal voltage	Un	150V
Tensione massima continuativa DC Maximum operating voltage	Uc	180V DC
Corrente impulsiva da fulmine (10/350 µs) Lightning impulse current (10/350 µs)	Iimp	2,5 kA
Corrente nominale di scarica (8/20 µs) Nominal discharge current (8/20 µs)	In	15 kA 15 kA
Attenuazione Insertion loss		< 3 dB
Livello di protezione voltaggio Voltage protection level	Up	350 V
Max corrente di carico Max load current	IL	750 mA
Frequenza massima Max frequency	Fmax	400 Mhz
Grado di protezione Protection degree	IP	55
Temperatura d'esercizio Range of operating temperatures		-40°C +85°C
Montaggio Mounting		A parete On wall
Sezioni di collegamento min/max Connection sections min/max		0.4 - 1,5 mm ²
Materiale dell'involucro Casing material		Termoplastico UL-94 V-0 Thermoplastic UL-94 V-0

Dimensioni in mm
Dimensions in mm

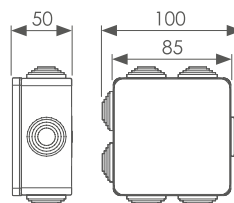

Normative di riferimento
Reference standards

EN 61643-21
IEC 61643-21
UL 497A

DATAPRO

Classe di protezione T1+T2 per reti ADSL e ANALOGICHE
Protection class T1+T2 for ADSL and ANALOG networks

Scaricatore di sovratensione combinato per la protezione di impianti telefonici ADSL e ANALOGICI.

Combined surge arrester for the protection of ADSL and ANALOG telephone systems.



Articolo Item	Poli Poles	Telesegnalamento Remote signalling	Moduli occupati Occupied modules
SN1410	2 Fili	NO	1

Schema di principio
Principle scheme

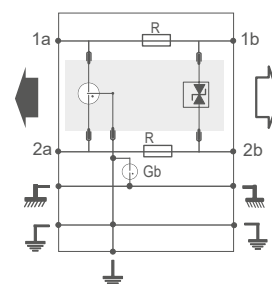

Dati tecnici Technical data		
Tensione nominale DC Nominal voltage	Un	150V
Massima tensione operativa DC Maximum operating voltage	Uc	170V DC
Corrente impulsiva da fulmine (10/350 µs) Lightning impulse current (10/350 µs)	Iimp	5 kA 5 kA
Corrente nominale di scarica (8/20 µs) Nominal discharge current (8/20 µs)	In	5 kA 5 kA
Corrente massima di scarica (8/20 µs) Max discharge current (8/20 µs)	I _{max}	20 kA 20 kA
Livello di protezione voltaggio Voltage protection level	Up	220 V
Max corrente di carico Max load current	IL	300 mA
Frequenza massima Max frequency	F _{max}	10 Mhz
Grado di protezione Protection degree	IP	20
Temperatura d'esercizio Range of operating temperatures		-40°C +85°C
Montaggio su guida metallica Mounting on metallic rail		DIN 35 (EN60715)
Sezioni di collegamento min/max Connection sections min/max		0,4-1,5 mm ²
Materiale dell'involucro (termoplastico) Casing material (thermoplastic)		UL 94V0
Coppia di serraggio Tightening torque	Su istruzioni di montaggio On assembly instructions	

Dimensioni in mm
Dimensions in mm

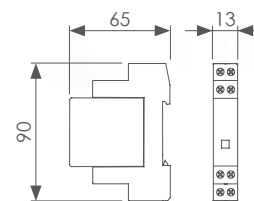

Normative di riferimento
Reference standards

EN 61643-21
IEC 61643-21
UL 497A

DATAPRO

Classe di protezione T1+T2 per linee di segnale
RS 422, RS485 - RS232, RS485 - 4-20mA - ISDN-T0, 48V line
Protection class T1+T2 for signal lines
RS 422, RS485 - RS232, RS485 - 4-20mA - ISDN-T0, 48V line

Scaricatore di sovratensione combinato per la protezione di impianti con interfaccia/segnale.
Combined surge arrester for the protection of systems with interface / signal.



Schema di principio
Principle scheme

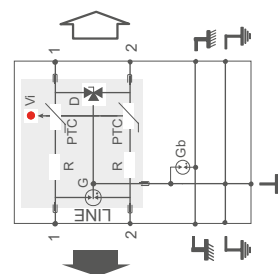

Dimensioni in mm
Dimensions in mm

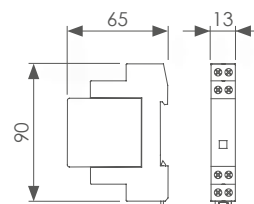

Normative di riferimento
Reference standards

EN 61643-21
IEC 61643-21
UL 497A

Articolo Item	Poli Poles	Telesegnalamento Remote signalling	Moduli occupati Occupied modules
SN1410.06	2 Fili	OTTICO OPTICAL	1
SN1410.12	2 Fili	OTTICO OPTICAL	1
SN1410.24	2 Fili	OTTICO OPTICAL	1
SN1410.48	2 Fili	OTTICO OPTICAL	1

Dati tecnici Technical data		SN1410-06	SN1410-12	SN1410-24	SN1410-48
Tensione nominale DC Nominal voltage	Un	6 V	12 V	24 V	48 V
Massima tensione operativa DC Maximum operating voltage	Uc	8 V	15 V	28 V	53 V
Corrente impulsiva da fulmine Lightning impulse current (10/350 µs)	Iimp	5 kA	5 kA	5 kA	5 kA
Corrente nominale di scarica Nominal discharge current (8/20 µs)	In	5 kA	5 kA	5 kA	5 kA
Corrente massima di scarica Maximum discharge current (8/20 µs)	I _{max}	20 kA	20 kA	20 kA	20 kA
Livello di protezione voltaggio Voltage protection level	Up	20 V	30 V	40 V	70 V
Max corrente di carico Max load current	I _L	300 mA	300 mA	300 mA	300 mA
Frequenza massima Max frequency	F _{max}	3 Mhz	3 Mhz	3 Mhz	3 Mhz
Grado di protezione Protection degree	IP	20	20	20	20
Temperatura d'esercizio Range of operating temperatures		-40°C +85°C			
Montaggio su guida metallica Mounting on metallic rail		DIN 35 (EN60715)			
Sezioni di collegamento min/max Connection sections min/max		0,4-1,5 mm ²			
Indicatore di guasto Fault indication		Verde/Rosso Green/Red			
Materiale dell'involucro (termoplastico) Casing material (thermoplastic)		UL94V0			
Coppia di serraggio Tightening torque		Su istruzioni di montaggio On assembly instructions			

DATAPRO

Classe di protezione T1+T2 per linee TV o SAT
Protection class T1+T2 for TV or SAT lines

Scaricatore di sovratensione combinato per la protezione delle linee TV o SATELLITARI con cavo coassiale RF.
Combined surge arrester for the protection of TV or SAT lines with RF coaxial cables.

CE



Articolo Item	Poli Poles	Telesegnalamento Remote signalling	Moduli occupati Occupied modules
SN1415TS	-	NO	-

Schema di principio
Principle scheme

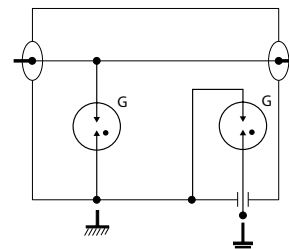

Dati tecnici Technical data		
Frequenza massima Max frequency	F	DC 1 GHZ
Potenza massima Max power	P	25 W
Impedenza impedance	Z	50/75 Ohms
Attenuazione Insertion loss		< 0,6 dB
Attenuazione del flusso di ritorno Return loss		> 20 dB
Corrente massima di scarica (8/20 µs) Maximum discharge current (8/20 µs)	I _{max}	20 kA
Corrente nominale di scarica (8/20 µs) Nominal discharge current (8/20 µs)	I _n	5 kA
Corrente impulsiva di scarica (10/350 µs) Pulse discharge current (10/350 µs)	I _{imp}	2,5 kA
Livello di protezione voltaggio Voltage protection level	U _p	600 V
Max corrente di carico Max load current	I _L	0,5 A
Grado di protezione Protection degree	IP	20
Temperatura d'esercizio Range of operating temperatures		-40°C +85°C
Montaggio Mounting		A Parete On wall
Collegamento Connection		RF
Materiale dell'involucro Casing material		Metallo/Plastica Metal/Plastic

Dimensioni in mm
Dimensions in mm

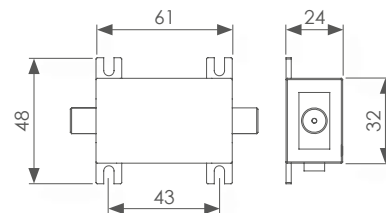

Normative di riferimento
Reference standards

EN 61643-21
IEC 61643-21
UL 497C/497E

DATAPRO

Classe di protezione T1+T2 per reti TVCC
Protection class T1+T2 for TVCC networks

Scaricatore di sovratensione combinato per la protezione di impianti TVCC

Combined surge arrester for the protection of TVCC systems.

CE



Articolo Item	Poli Poles	Telesegnalamento Remote signalling	Moduli occupati Occupied modules
SN1415BNC	-	NO	-

Schema di principio
Principle scheme

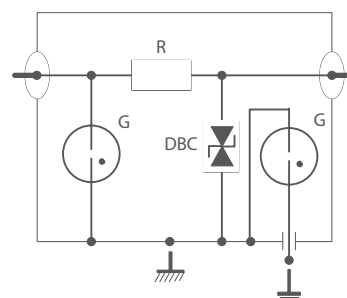

Dati tecnici Technical data		
Frequenza massima Max frequency	F	DC 100 MHz
Potenza massima Max power	P	6 W
Impedenza impedance	Z	50/75 Ohms
Corrente impulsiva da fulmine (10/350 µs) Lightning impulse current (10/350 µs)	I_{imp}	2,5 kA
Corrente nominale di scarica (8/20 µs) Nominal discharge current (8/20 µs)	I_n	5 kA
Corrente massima di scarica (8/20 µs) Maximum discharge current (8/20 µs)	I_{max}	10 kA
Attenuazione Insertion loss		≤ 0,5 dB
Attenuazione del flusso di ritorno Return loss		≥ 20 dB
Grado di protezione Protection degree	IP	20
Temperatura d'esercizio Range of operating temperatures		-40°C +85°C
Montaggio Mounting		A Parete On wall
Collegamento Connection		BNC
Materiale dell'involucro Casing material		Metallo/Plastica Metal/Plastic

Dimensioni in mm
Dimensions in mm

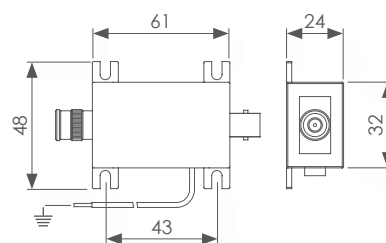

Normative di riferimento
Reference standards

EN 61643-21
IEC 61643-21
UL 497A

DATAPRO

Classe di protezione T1+T2 per impianti TVCC tipo POE
Protection class T1+T2 for TVCC systems POE type

Scaricatore di sovratensione combinato per la protezione di impianti TVCC tipo POE.

Combined surge arrester for the protection of TVCC systems POE type.



Articolo Item	Poli Poles	Telesegnalamento Remote signalling	Moduli occupati Occupied modules
SN1415POE	-	NO	-

Schema di principio
Principle scheme

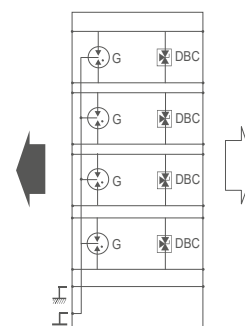

Dati tecnici Technical data		
Tensione nominale DC Nominal voltage	Un	48V DC
Massima tensione operativa DC Maximum operating voltage	Uc	60V DC
Corrente impulsiva da fulmine (10/350 µs) Lightning impulse current (10/350 µs)	Iimp	500A
Corrente nominale di scarica linea / terra (8/20 µs) Nominal discharge current line/ground (8/20 µs)	In	2000A
Corrente nominale di scarica linea / linea (8/20 µs) Nominal discharge current line/line (8/20 µs)	In	500A
Livello di protezione voltaggio Voltage protection level	Up	70V
Max corrente di carico Max load current	IL	1200 mA
Frequenza massima Max frequency	Fmax	> 100 Mhz
Grado di protezione Protection degree	IP	20
Temperatura d'esercizio Range of operating temperatures		-40°C +85°C
Montaggio su guida metallica Mounting on metallic rail		Con flangia a vite With screw flange
Collegamento Connection		RJ45/48
Materiale dell'involucro Casing material		Alluminio Aluminium

Dimensioni in mm
Dimensions in mm

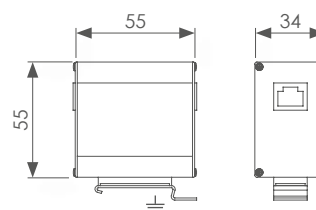

Normative di riferimento
Reference standards

EN 61643-21
IEC 61643-21
UL 497B

DATAPRO

Classe di protezione T2+T3 CAT 5E-RJ45
Protection T3 class T2+T3 CAT 5E-RJ45

Scaricatore di sovratensione per la protezione di una porta Ethernet CAT 5.

Surge arrester for the protection of a Ethernet port CAT 5.



Articolo Item	Poli Poles	Telesegnalamento Remote signalling	Moduli occupati Occupied modules
SN1415C5	-	NO	-

Schema di principio
Principle scheme

Dati tecnici
Technical data

Tensione nominale DC Nominal voltage DC	Un	5V DC
Massima tensione operativa DC Maximum operating voltage	Uc	8V DC
Corrente impulsiva da fulmine (10/350 µs) Lightning impulse current (10/350 µs)	Iimp	500A
Corrente nominale di scarica linea / terra (8/20 µs) Nominal discharge current line/ground (8/20 µs)	In	2000A
Corrente nominale di scarica linea / linea (8/20 µs) Nominal discharge current line/line (8/20 µs)	In	500A
Velocità massima trasmissione dati Max data speed		1 Gbps
Livello di protezione voltaggio Voltage protection level	Up	20V
Frequenza massima Max frequency	Fmax	> 100 Mhz
Max corrente di carico Max load current	IL	1000 mA
Grado di protezione Protection degree	IP	20
Temperatura d'esercizio Range of operating temperatures		-40°C +85°C
Montaggio su guida metallica Mounting on metallic rail		Con flangia a vite With screw flange
Collegamento Connection		RJ45
Materiale dell'involucro Casing material		Alluminio Aluminium

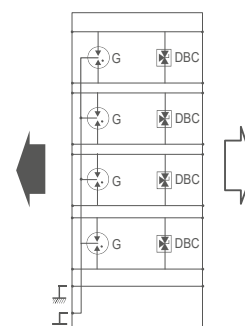

Dimensioni in mm
Dimensions in mm

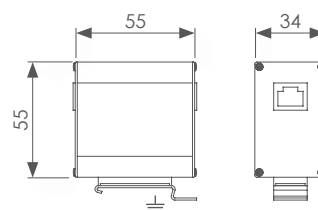

Normative di riferimento
Reference standards

EN 61643-21
IEC 61643-21
IEEE 80Z-3aN
UL 497B

DATAPRO

Classe di protezione T2+T3 CAT 6S-RJ45
Protection class T2+T3 CAT 6S-RJ45

Scaricatore di sovratensione per la protezione di una porta Ethernet CAT 6.

Surge arrester for the protection of a Ethernet port CAT 6.

CE



Articolo Item	Poli Poles	Telesegnalamento Remote signalling	Moduli occupati Occupied modules
SN1415C6	-	NO	-

Schema di principio
Principle scheme

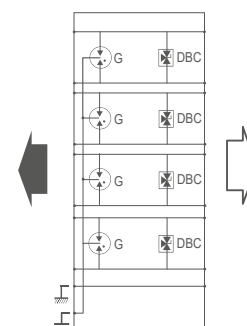

Dati tecnici Technical data		
Tensione nominale DC Nominal voltage DC	Un	5V DC
Massima tensione operativa DC Maximum operating voltage	Uc	8V DC
Corrente impulsiva da fulmine (10/350 µs) Lightning impulse current (10/350 µs)	Iimp	500A
Corrente nominale di scarica linea / terra (8/20 µs) Nominal discharge current line/ground (8/20 µs)	In	2000A
Corrente nominale di scarica linea / linea (8/20 µs) Nominal discharge current line/line (8/20 µs)	In	500A
Velocità massima trasmissione dati Max data speed		10 Gbps
Livello di protezione voltaggio Voltage protection level	Up	20V
Frequenza massima Max frequency	Fmax	250 Mhz
Max corrente di carico Max load current	IL	1000 mA
Grado di protezione Protection degree	IP	20
Temperatura d'esercizio Range of operating temperatures		-40°C +85°C
Montaggio su guida metallica Mounting on metallic rail		Con flangia a vite With screw flange
Collegamento Connection		RJ45
Materiale dell'involucro Casing material		Alluminio Aluminium

Dimensioni in mm
Dimensions in mm

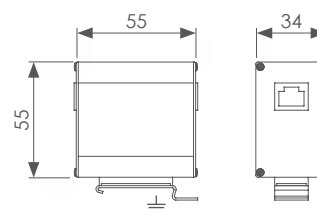

Normative di riferimento
Reference standards

EN 61643-21
IEC 61643-21
IEEE 80Z-3aN
UL 497B

Dispensori di terra a croce Ground rods cross profile

Articolo Item	313.10	313.15	313.20	313.25
Materiale Material	Acciaio zincato a caldo Hot galvanized steel			
Dimensioni Dimensions	50 x 50 x 5 mm			
Lunghezza Length	1000 mm	1500 mm	2000 mm	2500 mm
Fori su profilo Holes on profile	2 x Ø11 mm	2 x Ø11 mm	2 x Ø11 mm	2 x Ø11 mm
Fori su bandiera Holes on plate	4 x Ø11 mm	4 x Ø11 mm	4 x Ø11 mm	4 x Ø11 mm
Riferimento norme Standards reference	CEI EN 50164-2	CEI EN 50164-2	CEI EN 50164-2	CEI EN 50164-2

Articolo Item	312.10	312.15
Materiale Material	Acciaio zincato a caldo Hot galvanized steel	
Dimensioni Dimensions	50 x 50 x 3 mm	
Lunghezza Length	1000 mm	1500 mm
Fori su profilo Holes on profile	2 x Ø11 mm	2 x Ø11 mm
Fori su bandiera Holes on plate	4 x Ø11 mm	4 x Ø11 mm
Riferimento norme Standards reference	CEI EN 50164-2	CEI EN 50164-2



Cartello indicatore per dispersori di terra Ground rod signboard

Articolo Item	DCT2020	
Materiale Material	Alluminio Aluminium	
Dimensione Dimension	200 x 200 mm	
Descrizione Description	Spazio per numerazione Space for numbering	

Articolo Item	DCT2030CN	
Materiale Material	Alluminio Aluminium	
Dimensione Dimension	200 x 300 mm	
Descrizione Description	Spazio per numerazione e coordinate Space for numbering and coordinates	

Morsetti di collegamento per dispersori a croce e piastra Connection terminals for cross and plate ground rods

			
Articolo Item	303.1	3303.1	303.2
Materiale base Base materia	Alluminio Aluminium	Zama Zamak	Alluminio Aluminium
Materiale bullone Bolt material	Acciaio nichelato nickel-plated steel	Acciaio ramato Copper-plated steel	Acciaio nichelato nickel-plated steel
Diametro foro Hole diameter	10,2 mm	10,2 mm	10,2 mm
Per conduttori tondi For round conductors	1 x Ø 8/10 mm	1 x Ø 8/10 mm	2 x Ø 8/10 mm
Riferimento norme Standards reference	CEI EN 50164-1	CEI EN 50164-1	CEI EN 50164-1

Dispersore di terra a piastra Ground earthing plate

Articolo Item	327F2	
Materiale Material	Acciaio zincato a caldo Hot galvanized steel	
Dimensioni piastra Plate dimensions	500 x 500 x 3 mm	
Dimensioni bandella Band dimensions	50 x 3 mm	
Lunghezza bandella Band length	1 m	
Fori su bandella Holes on band	2 x Ø11 mm	
Riferimento norme Standards reference	CEI EN 50164-2	

Sali per aumentare la conducibilità del terreno Salts compound to increase the ground conductivity

Articolo Item	313SC	
Descrizione Description	Soluzione chimica-elettrolitica atossica di sali No-toxic chemical electrolytic salts	
Quantità Quantity	3,5 Kg	
Modalità d'uso How to use	Da diluire con acqua To be diluted with water	

Dispersore di terra tondo con estremità filettate Ø18 mm Round earth rod with threaded ends Ø18 mm

Articolo Item	3115.18	DMF18	DB18	
Descrizione Description	Spessore ramatura Copper thickness 100 µm	Manicotto filettato Threaded sleeve	Battipalo Rod driver	
Materiale Material	Acciaio ramato Copper plates steel	Ottone Brass	Acciaio ramato Copper-plated steel	
Dimensione Dimension	Ø 18 x 1500 mm	Ø18 mm	Ø18 mm	
Riferimento norme Standards reference	CEI EN 50164-2	CEI EN 50164-2	CEI EN 50164-2	

Dispersore di terra tondo con estremità lisce Ø18 mm Round earth rod with smooth ends Ø18 mm

Articolo Item	3315.18	DML18	DB18	
Descrizione Description	Spessore ramatura Copper thickness 100 µm	Manicotto di giunzione Connection sleeve	Battipalo Rod driver	
Materiale Material	Acciaio ramato Copper plates steel	Ottone Brass	Acciaio ramato Copper-plated steel	
Dimensione Dimension	Ø 18 x 1500 mm	Ø18 mm	Ø18 mm	
Riferimento norme Standards reference	CEI EN 50164-2	CEI EN 50164-2	CEI EN 50164-2	

Morsetti di collegamento per dispersori tondi Ø18 mm Connection clamps for round rods Ø18 mm

Articolo Item	3403.20	2403.20	
Materiale base Base material	Zama ramata Copper-plated zamak	Zama zincata Zinc plated zamak	
Materiale bullone Bolt material	Acciaio ramato Copper-plated steel	Acciaio zincato Galvanized steel	
Per conduttori tondi For round conductors	1 x Ø 8/10 mm	1 x Ø 8/10 mm	
Riferimento norme Standards reference	CEI EN 50164-1	CEI EN 50164-1	

Articolo Item	3404.20	
Materiale base Base material	Acciaio ramato Copper-plated steel	
Materiale bullone Bolt material	Acciaio zincato Galvanized steel	
Per conduttori tondi For round conductors	1 x Ø 8/10 mm	
Riferimento norme Standards reference	CEI EN 50164-1	

Articolo Item	2404.20	
Materiale base Base material	Rame nichelato Nickel-plated copper	
Materiale bullone Bolt material	Acciaio inox Stainless steel	
Per conduttori tondi For round conductors	2 x Ø 8/10 mm	
Riferimento norme Standards reference	CEI EN 50164-1	

Collare equipotenziale per tubi Innocenti Equipotential collar for Innocenti tubes

Articolo Item	DMTI	
Materiale collare Collar material	Acciaio Steel	
Trattamento collare Collar treatment	Zincato Galvanized	
Cavi collegabili Connectable cables	max 25/70 mm ²	
Campo di serraggio Pipe clamping range	Ø46/52 mm	
Riferimento norme Standards reference	CEI EN 50164-1	

Dispensore di terra tondo prolungabile Ø 20 mm Round extendable earth rod Ø 20 mm

Articolo Item	315.20	
Materiale Material	Acciaio zincato a caldo Hot galvanized steel	
Dimensione Dimension	Ø 20 mm	
Lunghezza Length	1,5 m	
Riferimento norme Standards reference	CEI EN 50164-2	

Accessori per pali Ø 20 mm Accessories for Ø 20 mm poles

Articolo Item	DP315	DB20	
Estremità barra Bar extremity	Punta per infissione Driving dart	Battipalo Rod driver	
Materiale Material	Acciaio elettrozincato Electro galvanized steel	Acciaio Steel	
Riferimento norme Standards reference	CEI EN 50164-2	CEI EN 50164-2	

Morsetti di collegamento per dispersori tondi Ø 20 mm Connection clamps for round rods Ø 20 mm

Articolo Item	DMC315	DMC515	
Materiale base Base material	Acciaio zincato a caldo Hot galvanized steel	Acciaio inox Stainless steel	
Struttura Structure	3 piastre 3 plates	2 piastre 2 plates	
Per conduttori tondi For round conductors	Ø 8/10 mm	Ø 8/10 mm	
Per conduttori piatti For flat conductors	30x4 mm	30x4 mm	
Per pali For round rods	Ø 20 mm	Ø 20 mm	
Riferimento norme Standards reference	CEI EN 50164-1	CEI EN 50164-1	

Fascette per collegamenti equipotenziali Equipotential band clamps



Articolo Item	D36.1	D37.0	D37.1	D37.4	D37.6
Materiale fascetta Band material	Acciaio inox Stainless steel	Acciaio inox Stainless steel	Acciaio inox Stainless steel	Acciaio inox Stainless steel	Acciaio inox Stainless steel
Materiale morsetto Clamp material	Acciaio zincato Zinc plated steel	Acciaio zincato Zinc plated steel	Acciaio zincato Zinc plated steel	Acciaio zincato Zinc plated steel	Acciaio zincato Zinc plated steel
Numero viti Screws number	1	2	3	3	3
Dimensione Dimension	6 x 215 mm	14 x 120 mm	23 x 215 mm	23 x 370 mm	23 x 570 mm
Cavi collegabili Connectable cables	2,5/6 mm ²	2,5/16 mm ²	2,5/16 mm ²	2,5/16 mm ²	2,5/16 mm ²
Campo di serraggio Pipe clamping range	Ø 18/58 mm	Ø 8/18 mm	Ø 18/58 mm	Ø 18/114 mm	Ø 18/165 mm
Campo di serraggio Pipe clamping range	3/8" - 2"	1/8" - 3/8"	3/8" - 2"	3/8" - 4"	3/8" - 6"

Collari equipotenziali Equipotential collar clamps

Articolo Item	D40.38	D40.12	D40.34	D40.01
Materiale collare Collar material	Zama Zamak	Zama Zamak	Zama Zamak	Zama Zamak
Materiale morsetto Clamp material	Acciaio zincato Zinc plated steel	Acciaio zincato Zinc plated steel	Acciaio zincato Zinc plated steel	Acciaio zincato Zinc plated steel
Cavi collegabili Connectable cables	max 25 mm ²	max 25 mm ²	max 25 mm ²	max 25 mm ²
Campo di serraggio Pipe clamping range	Ø 15/18 mm	Ø 18/22 mm	Ø 25/28 mm	Ø 30/36 mm
Campo di serraggio Pipe clamping range	3/8"	1/2"	3/4"	1"

Articolo Item	D40.114	D40.112	D40.02
Materiale collare Collar material	Zama Zamak	Zama Zamak	Zama Zamak
Materiale morsetto Clamp material	Acciaio zincato Zinc plated steel	Acciaio zincato Zinc plated steel	Acciaio zincato Zinc plated steel
Cavi collegabili Connectable cables	max 25 mm ²	max 25 mm ²	max 25 mm ²
Campo di serraggio Pipe clamping range	Ø 40/45 mm	Ø 48/54 mm	Ø 58/63 mm
Campo di serraggio Pipe clamping range	1 - 1/4"	1 - 1/2"	2"



Morsetti a pettine con 1 bullone

Comb clamps with 1 bolt

Articolo Item	DM05.1	DM08.1	
Materiale piastrine Plate material	Ottone Brass		
Materiale bullone Support material	Acciaio zincato Galvanized steel		
Numero bulloni Bolts number	1	1	
Per conduttori For conductors	Ø3/5 mm	Ø6/8 mm	
Sezione conduttori Conductors section	6-20 mm ²	25-50 mm ²	

Morsetti a pettine con 2 bulloni

Comb clamps with 2 bolts

Articolo Item	DM05.2	DM08.2	DM12.2	DM14.2	
Materiale piastrine Plate material	Ottone Brass				
Materiale bullone Support material	Acciaio zincato Galvanized steel				
Numero bulloni Bolts number	2	2	2	2	
Per conduttori For conductors	Ø3/5 mm	Ø6/8 mm	Ø9/12 mm	Ø12/14 mm	
Sezione conduttori Conductors section	6-20 mm ²	25-50 mm ²	60-95 mm ²	110-155 mm ²	

Morsetti di sezionamento

Sectioning clamp

Articolo Item	22CP	
Materiale base Base material	Plastica Plastic	
Materiale morsetti Clamps material	Rame nichelato Nickel-plated copper	
Materiale piastra Plate material	Acciaio zincato Zinc plated steel	
Per conduttori tondi For round conductors	2 x Ø 8/10 mm	
Riferimento norme Standards compliance	CEI EN 50164-1	

Articolo Item	DS22	
Materiale base Base material	Plastica Plastic	
Materiale morsetto Clamp material	Acciaio inox Stainless steel	
Per conduttori tondi For round conductors	2 x Ø 8/10 mm	
Riferimento norme Standards reference	CEI EN 50164-1	

Barra di adduzione a terra con testa piatta Earth lead-in rods with flat head

Articolo Item	386A100	386A200	
Materiale Material	Acciaio zincato a caldo Hot galvanized steel	Acciaio zincato a caldo Hot galvanized steel	
Dimensioni Dimensions	Ø16 x 1.000 mm	Ø16 x 2.000 mm	
Numero fori Number of holes	2 x Ø 11 mm	2 x Ø 11 mm	
Riferimento norme Standards compliance	CEI EN 50164-2	CEI EN 50164-2	

Morsetto di collegamento per barra di adduzione Connection clamp for earth lead-in rod

Articolo Item	27.816	
Materiale Material	Acciaio zincato a caldo Hot galvanized steel	
Per conduttori tondi For round conductors	1 x Ø 8/10 mm 1 x Ø 16 mm	
Riferimento norme Standards reference	CEI EN 50164-1	

Supporto a parete per barra di adduzione Wall holder for earth lead-in rod

Articolo Item	1370B	
Materiale piastrina Plate material	Acciaio zincato a caldo Hot galvanized steel	
Materiale viti Screws material	Acciaio inox Stainless steel	
Per asta di adduzione For earth lead-in rod	Ø 16 mm	
Riferimento norme Standards compliance	CEI EN 50164-1	

Piastre equipotenziali Equipotential plates

Articolo Item	TE5	TE8	
Materiale piastra Plate material	Rame Copper	Rame Copper	
Materiale Material	Acciaio ramato Copper plated steel	Acciaio ramato Copper plated steel	
Dimensione Dimension	200 x 30 x 30 mm	250 x 50 x 40 mm	
Cavi collegabili Connectable cables	4 x 35 mm ² 1 x 50 mm ²	4 x 35 mm ² / 3 x 50 mm ² 1 x 120 mm ²	
Riferimento norme Standards reference	CEI EN 50164-1	CEI EN 50164-1	
Certificazioni Certifications	CE	CE	

Per la gamma completa di piastre e morsettiere equipotenziali vedere pagine 240/245
For the complete range of equipotential bars and terminal blocks see pages 240/245

Combinazione di materiali di sistemi di captazione e di calate Combination of materials for air-termination systems and down conductors

Materiale Material	Acciaio Steel	Alluminio Aluminium	Rame Copper	Acciaio inox Stainless steel
Acciaio zincato (Fe/tZn) Zinc plated steel (Fe/tZn)	SI - YES	SI - YES	NO	SI - YES
Alluminio Aluminium	SI - YES	SI - YES	NO	SI - YES
Rame Copper	NO	NO	SI - YES	SI - YES
Acciaio Inox Stainless steel	SI - YES	SI - YES	SI - YES	SI - YES

Conduttori tondi - Riferimento norme CEI EN 50164-2 Round conductors - Standards compliance CEI EN 50164-2

Articolo Item	3318.8		
Diametro Tondino Round conductor Ø	Ø 8 mm		
Materiale Material	Rame Copper		
Sezione Section	50 mm ²		
Corrente corto circuito Short-circuit current	9,8 kA		
Peso al metro Weight per meter	0,450 g (1 Kg = 2,22 m)		
Peso matassa Roll weight	ca. 50 Kg		

Articolo Item	318.8	318.10	
Diametro Tondino Round conductor Ø	Ø 8 mm	Ø 10 mm	
Materiale Material	Acciaio zincato a caldo Hot galvanized steel	Acciaio zincato a caldo Hot galvanized steel	
Sezione Section	50 mm ²	78 mm ²	
Corrente corto circuito Short-circuit current	-	5,5 kA	
Peso al metro Weight per meter	0,400 g (1 Kg = circa 2,50 m)	0,630 g (1 Kg = circa 1,59 m)	
Peso matassa Roll weight	ca. 40 Kg	ca. 46,5 Kg	

Articolo Item	4318.8	4318.10	
Diametro Tondino Round conductor Ø	Ø 8 mm	Ø 10 mm	
Materiale Material	Alluminio Aluminium	Alluminio Aluminium	
Sezione Section	50 mm ²	78 mm ²	
Corrente corto circuito Short-circuit current	-	-	
Peso al metro Weight per meter	0,135 g (1 Kg = circa 7,4 m)	0,212 g (1 Kg = circa 4,7 m)	
Peso matassa Roll weight	ca. 20 Kg	ca. 20 Kg	

Conduttori piatti Flat conductors

Articolo Item	317.30.3	317.30.35	
Dimensioni bandella Conductor dimensions	30 x 3 mm	30 x 3,5 mm	
Materiale Material	Acciaio zincato a caldo Hot galvanized steel	Acciaio zincato a caldo Hot galvanized steel	
Sezione Section	90 mm ²	105 mm ²	
Corrente corto circuito Short-circuit current	-	7,3 kA	
Peso al metro Weight per meter	0,721 g (1 Kg = 1,39 m)	0,840 g (1 Kg = 1,19 m)	
Peso matassa Roll weight	ca. 50 Kg	ca. 50 Kg	
Riferimento norme Standards reference	CEI EN 50164-2	CEI EN 50164-2	

Nastro bimetallico per collegamento conduttori di materiali diversi Bimetal tape for connecting conductors of different materials

Articolo Item	D1053	D105R	D105A	
Dimensioni Dimensions	Striscia Strip 40 x 500 mm	Capsula Capsule 40 mm	Capsula Capsule 40 mm	
Spessore Section	0,5 mm	0,5 mm	0,5 mm	
Materiale Material	Rame/Alluminio Copper/Aluminium	Rame esterno Alluminio interno Copper outside Aluminium inside	Rame interno Alluminio esterno Copper inside Aluminium outside	

Profili di protezione per conduttori Protection profile for conductors

Articolo Item	PV4545	PV7575	
Materiale Material	Vetroresina Fiberglass	Vetroresina Fiberglass	
Dimensioni Dimensions	45x45 mm	75x75 mm	
Lunghezza Length	3000 mm	3000 mm	

Articolo Item	C45	C75	
Materiale Material	Acciaio zincato a caldo Hot galvanized steel	Acciaio zincato a caldo Hot galvanized steel	
Dimensioni Dimensions	45x45 mm	75x75 mm	
Punti di fissaggio Fixing points	2	2	

Conduttore isolato sistema "HVC-protected" Insulated conductor "HVC-protected" system

Articolo Item	DHVC28
Distanza di separazione equivalente "S" (aria) Equivalent separation distance "S" (air)	<850 mm
Distanza di separazione equivalente "S" (materiale solido) Equivalent separation distance "S" (solid material)	<1550 mm
Diametro esterno e peso Outer diameter and weight	28 mm 0.918 Kg/m
Raggio minimo di curvatura Minimum bending radius	250 mm
Temperatura d'installazione Installation temperature	> 0°C
Range di temperatura permanente Permanent temperature range	-20°C / +70°C
Max carico di trazione Max tensile load	1500 N
Carico d'incendio Fire load	5,83 kWh/m
Resistenza all'intemperie e ai raggi UV Weather proof and UV resistant	SI Yes



Classe dell'LPS LPS class	Corrente fulmine MAX Max lightning current	N° calate N° descent	Lunghezza max cavo* Max conductor length*
I	200 kA	1	-
		2	21 m
		3	32 m
II	150 kA	1	14 m
		2	28 m
		3	42 m
III + IV	100 kA	1	21 m
		2	42 m
		3	64 m

* Per "S" = 850 mm in aria*
For "S" = 850 mm in air

Vantaggi del conduttore ad alto VOLTAGGIO DHVC28

- Riduce significativamente il tempo di installazione
- Il collegamento equipotenziale è realizzato dallo schermo della calza di rame
- Protezione meccanica e chimica con rivestimento resistente ai raggi UV
- Nessuna necessità di distanza di separazione nella zona della base

Advantages of the high VOLTAGE conductor DHVC28

- Significantly reduced installation work and time
- The equipotential bonding is made by the shield of the copper braid
- Mechanical and chemical protection with UV resistant coating
- No additional separation distances must be observed in the base area



Terminali di collegamento per conduttore HVC
Connection terminals for HVC conductor

Articolo Item	DCU28	DCA28	
Descrizione Description	Unità di connessione interna Interior head unit	Unità di connessione esterna External head unit	
			

Articolo Item	DCF28		
Descrizione Description	Unità di connessione per conduttore a terra Base unit for earthing connection		
			

Piastra per il fissaggio esterno del conduttore HVC
Plate for external fixing of HVC conductor

Articolo Item	DPF28	
Fori Holes	Ø 10,5 mm	
Materiale Material	Acciaio inox Stainless steel	



Supporti di fissaggio per conduttore HVC Fixing supports for HVC conductor

Articolo Item	DCS28	DCP28	
Descrizione Description	Supporto a parete Wall support	Supporto a parete Wall support	
Materiale Material	Acciaio inox Stainless steel	Plastica Plastic	
Foro di fissaggio Fixing hole	Ø 6,5 mm	Ø 6,5 mm	

Articolo Item	DST28	
Descrizione Description	Supporto per tetto piano Flat roof support	
Materiale Material	Mattonella in cemento, supporto e base in plastica Concrete tile, support and base in plastic	

Articolo Item	DPT28	
Descrizione Description	Supporto a fascetta per tubi Ø 50/300 mm Tape pipe clamp for pipes Ø 50/300 mm	
Materiale Material	Acciaio inox Stainless steel	

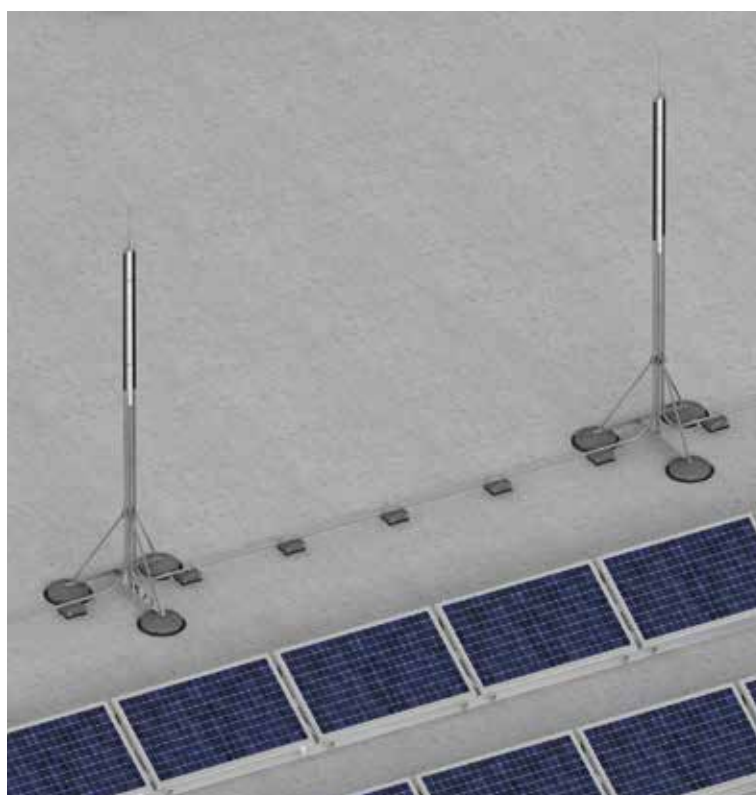

Accessori per la preparazione di cavi HVC Accessories for preparing HVC cables

Articolo Item	DCE28	
Descrizione Description	Supporto a parete in acciaio inox Wall support in stainless steel	

Articolo Item	DCT28	
Descrizione Description	Attrezzo per la spelatura centrale del cavo HVC Tool for central stripping of HVC cable	



1



2



3



4



5



6



Accessori per aste di captazione e strallaggio Accessories for air-termination rods and cables

Articolo Item	DFA04	DFA06	DFA10	
Descrizione Description	Fune in acciaio zincato per captazione e strallaggio Zinc plated steel rope for pick-up and cable stay			
Dimensione fune Rope dimension	Ø 4 mm - 10 mm ² 19 fili - wires	Ø 6 mm - 22 mm ² 19 fili - wires	Ø 10 mm - 60 mm ² 19 fili - wires	
Carico di rottura Ultimate strength	1.050 kg/m	2.350 kg/m	6.500 kg/m	

Articolo Item	DFR10	
Descrizione Description	Redancia Ø 10 mm, in acciaio zincato Zinc plated steel redance, Ø 10 mm	

Articolo Item	DFM10	
Descrizione Description	Morsetto Ø 10 mm, in acciaio zincato Zinc plated steel clamp, Ø 10 mm	

Articolo Item	DFT10	
Descrizione Description	Tirante Ø 10 mm, in acciaio zincato Zinc plated steel tension bar, Ø 10 mm	

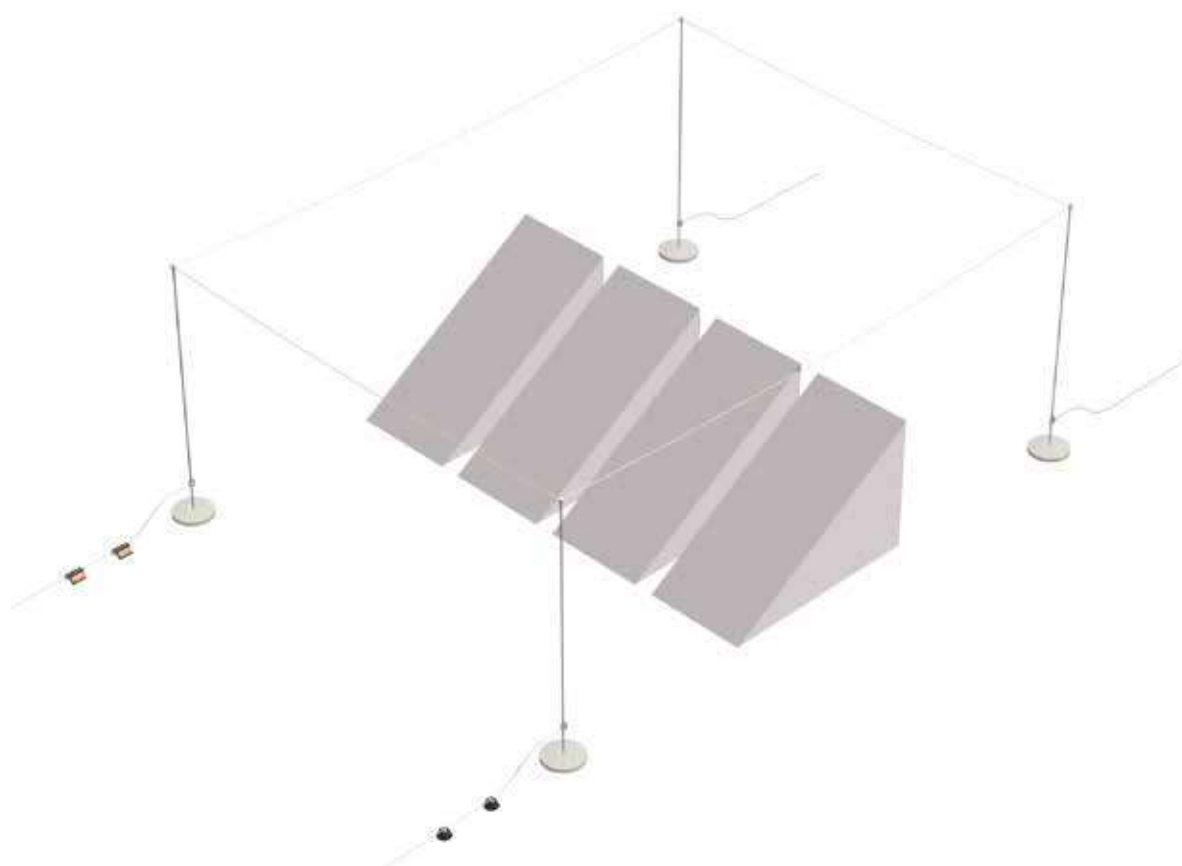

Asta di captazione non isolata in acciaio inox

Non-insulated air-termination rod in stainless steel

Articolo Item	DABI030	DABI035	DABI040
Altezza totale Total height	3,0 m	3,5 m	4,0 m
Dimensioni asta Rod dimension	Ø 42 x 1.500 mm	Ø 42 x 2.000 mm	Ø 42 x 2.500 mm
Dimensioni astina Terminal rod dimension	Ø 16 x 1.500 mm	Ø 16 x 1.500 mm	Ø 16 x 1.500 mm
Materiale asta Rod material	Acciaio inox Stainless steel	Acciaio inox Stainless steel	Acciaio inox Stainless steel
Materiale astina Terminal rod material	Alluminio Aluminium	Alluminio Aluminium	Alluminio Aluminium
Parti asta Rod parts	2	2	2
Riferimento norme Standards compliance	CEI EN 50164-1	CEI EN 50164-1	CEI EN 50164-1
Base pavimento consigliata Recommended floor base	DACB65	DACB65	DACB65

Articolo Item	DABI045	DABI050	DABI055
Altezza totale Total height	4,5 m	5,0 m	5,5 m
Dimensioni asta Rod dimension	Ø 42 x 3.500 mm	Ø 42 x 3.500 mm	Ø 42 x 4.000 mm
Dimensioni astina Terminal rod dimension	Ø 16 x 1.000 mm	Ø 16 x 1.500 mm	Ø 16 x 1.500 mm
Materiale asta Rod material	Acciaio inox Stainless steel	Acciaio inox Stainless steel	Acciaio inox Stainless steel
Materiale astina Terminal rod material	Alluminio Aluminium	Alluminio Aluminium	Alluminio Aluminium
Parti asta Rod parts	2	2	2
Riferimento norme Standards compliance	CEI EN 50164-1	CEI EN 50164-1	CEI EN 50164-1
Base pavimento consigliata Recommended floor base	DACB1	DACB1	DACB1

Articolo Item	DABI060	DABI070	DABI080
Altezza totale Total height	6,0 m	7,0 m	8,0 m
Dimensioni asta Rod dimension	Ø 42 2.000 + 2.000 mm	Ø 42 3.000 + 2.000 mm	Ø 42 4.000 + 2.000 mm
Dimensioni astina Terminal rod dimension	Ø 16 x 2.000 mm	Ø 16 x 2.000 mm	Ø 16 x 2.000 mm
Materiale asta Rod material	Acciaio inox Stainless steel	Acciaio inox Stainless steel	Acciaio inox Stainless steel
Materiale astina Terminal rod material	Alluminio Aluminium	Alluminio Aluminium	Alluminio Aluminium
Parti asta Rod parts	3	3	3
Riferimento norme Standards compliance	CEI EN 50164-1	CEI EN 50164-1	CEI EN 50164-1
Base pavimento consigliata Recommended floor base	DACB2	DACB2 / DACB3	DACB3



Per staffe e basi a pavimento vedere pagina 406
 For brackets and floor bases see page 406

Asta di captazione isolata per conduttore interno Insulated air-termination rod for internal conductor

Articolo Item	DAC030	DAC040	DAC050
Altezza totale Total height	3,0 m	4,0 m	5,0 m
Dimensioni asta Rod dimension	Ø 42 x 900 mm	Ø 42 x 1.900 mm	Ø 42 x 2.900 mm
Dimensioni parte isolante Insulated rod dimension	Ø 42 x 1.700 mm	Ø 42 x 1.700 mm	Ø 42 x 1.700 mm
Dimensioni astina Terminal rod dimension	Ø 16 x 400 mm	Ø 16 x 400 mm	Ø 16 x 400 mm
Materiale asta Rod material	Acciaio inox Stainless steel	Acciaio inox Stainless steel	Acciaio inox Stainless steel
Materiale parte isolante Insulated rod material	Fibra di vetro Fiberglass	Fibra di vetro Fiberglass	Fibra di vetro Fiberglass
Materiale astina Terminal rod material	Alluminio Aluminium	Alluminio Aluminium	Alluminio Aluminium
Riferimento norme Standards compliance	CEI EN 50164-1	CEI EN 50164-1	CEI EN 50164-1
Base pavimento consigliata Recommended floor base	DACB65	DACB65	DACB1

Articolo Item	DAC060	DAC070	DAC080
Altezza totale Total height	6000 mm	7000 mm	8000 mm
Dimensioni asta Rod dimension	Ø 42 x 3900 mm	Ø 42 x 4900 mm	Ø 42 x 5900 mm
Dimensioni parte isolante Insulated rod dimension	Ø 42 x 1700 mm	Ø 42 x 1700 mm	Ø 42 x 1700 mm
Dimensioni astina Terminal rod dimension	Ø 16 x 400 mm	Ø 16 x 400 mm	Ø 16 x 400 mm
Materiale asta Rod material	Acciaio inox Stainless steel	Acciaio inox Stainless steel	Acciaio inox Stainless steel
Materiale parte isolante Insulated rod material	Fibra di vetro Fiberglass	Fibra di vetro Fiberglass	Fibra di vetro Fiberglass
Materiale astina Terminal rod material	Alluminio Aluminium	Alluminio Aluminium	Alluminio Aluminium
Riferimento norme Standards compliance	CEI EN 50164-1	CEI EN 50164-1	CEI EN 50164-1
Base pavimento consigliata Recommended floor base	DACB1	DACB2 / DACB3	DACB3

Le aste di captazione DAC hanno la predisposizione per l'inserimento interno del conduttore ad alto potenziale DHVC28. Per staffe e basi a pavimento vedere pagina 406

The air-termination rods DAC are designed for the internal insertion of the high-potential conductor DHVC28. For brackets and floor bases see page 406



Installazione del conduttore HVC in versione interna all'asta di captazione con base treppiede (vedi pag. 406)

Installation of the HVC conductor in the internal version of the air-termination rod with tripod base (see page 406)



Asta di captazione isolata per conduttore esterno Insulated air-termination rod for external conductor

Articolo Item	DACI3300	DACI3350	DACI3400
Altezza totale Total height	3,75 m	4,25 m	4,75 m
Dimensioni asta Rod dimension	Ø 42 x 1.500 mm	Ø 42 x 2.000 mm	Ø 42 x 2.500 mm
Dimensioni parte isolante Insulated rod dimension	Ø 42 x 1.500 mm	Ø 42 x 1.500 mm	Ø 42 x 1.500 mm
Dimensioni astina Terminal rod dimension	Ø 16 x 750 mm	Ø 16 x 750 mm	Ø 16 x 750 mm
Materiale asta Rod material	Acciaio inox Stainless steel	Acciaio inox Stainless steel	Acciaio inox Stainless steel
Materiale parte isolante Insulated rod material	Fibra di vetro Fiberglass	Fibra di vetro Fiberglass	Fibra di vetro Fiberglass
Materiale astina Terminal rod material	Alluminio Aluminium	Alluminio Aluminium	Alluminio Aluminium
Riferimento norme Standards compliance	CEI EN 50164-1	CEI EN 50164-1	CEI EN 50164-1
Base pavimento consigliata Recommended floor base	DACB65	DACB65	DACB1

Articolo Item	DACI3450	DACI3500	DACI3550
Altezza totale Total height	5,25 m	5,75 m	6,25 m
Dimensioni asta Rod dimension	Ø 42 x 3000 mm	Ø 42 x 3500 mm	Ø 42 x 4000 mm
Dimensioni parte isolante Insulated rod dimension	Ø 42 x 1500 mm	Ø 42 x 1500 mm	Ø 42 x 1500 mm
Dimensioni astina Terminal rod dimension	Ø 16 x 750 mm	Ø 16 x 750 mm	Ø 16 x 750 mm
Materiale asta Rod material	Acciaio inox Stainless steel	Acciaio inox Stainless steel	Acciaio inox Stainless steel
Materiale parte isolante Insulated rod material	Fibra di vetro Fiberglass	Fibra di vetro Fiberglass	Fibra di vetro Fiberglass
Materiale astina Terminal rod material	Alluminio Aluminium	Alluminio Aluminium	Alluminio Aluminium
Riferimento norme Standards compliance	CEI EN 50164-1	CEI EN 50164-1	CEI EN 50164-1
Base pavimento consigliata Recommended floor base	DACB1	DACB2	DACB2

Le aste di captazione DACI sono fornite con staffe di fissaggio a parete e asta distanziale laterale per l'installazione della fune in acciaio.
 Per basi a pavimento vedere pagina 406

The air-termination rods DACI are supplied with wall brackets and lateral stand-off for steel rope. For floor bases see page 406





Piastra per il fissaggio esterno conduttore HVC Plate for external fixing of HVC conductor

Articolo Item	DPF28	
Fori Holes	Ø 10,5 mm	
Materiale Material	Acciaio inox Stainless steel	



Staffe a parete per aste di captazione Wall brackets for air-termination rods

Articolo Item	DASP	
Descrizione Description	<p>Staffa in acciaio inox con 2 fori Ø 10,5 mm per aste di captazione Ø 42 mm altezza max 4,25 m distanza da parete 200 mm (altre misure su richiesta)</p> <p>Stainless steel bracket with 2 holes Ø 10,5 mm for air-termination rods Ø 42 mm height max 4,25 m distance from the wall 200 mm (other dimension on request)</p>	
Articolo Item	DASF	
Descrizione Description	<p>Staffa in acciaio inox con 4 fori Ø 10,5 mm per aste di captazione Ø 42 mm altezza max 6 m distanza da parete 200 mm (altre misure su richiesta)</p> <p>Stainless steel bracket with 4 holes Ø 10,5 mm for air-termination rods Ø 42 mm height max 6 m distance from the wall 200 mm (other dimension on request)</p>	
Articolo Item	DTSP	
Descrizione Description	<p>Tassello di fissaggio in acciaio inox M10</p> <p>Fixing anchors in stainless steel M10</p>	

Base treppiede a pavimento per aste di captazione Floor tripod base for air-termination rods

Articolo Item	DACB1	
Descrizione Description	<p>Base in acciaio inox per aste Ø 42 mm con altezza max 5500 mm. Ingombro 1350x1350 mm con 3 blocchi in cemento da 25 Kg e supporto in plastica</p> <p>Stainless steel base for air-termination rods Ø 42 mm height max 5.5 meters. Footprint 1350x1350 mm with 3 concrete blocks of 25 Kg and plastic support</p>	
Articolo Item	DACB2	
Descrizione Description	<p>Base in acciaio inox per aste Ø 42 mm con altezza max 6000 mm. Ingombro 1850x1850 mm con 6 blocchi in cemento da 12 Kg e supporto in plastica</p> <p>Stainless steel base for air-termination rods Ø 42 mm height max 6 meters. Footprint 1850x1850 mm with 6 concrete blocks of 12 Kg and plastic support</p>	
Articolo Item	DACB3	
Descrizione Description	<p>Base in acciaio inox per aste Ø 42 mm con altezza max 8000 mm. Ingombro 1850x1850 mm con 6 blocchi in cemento da 25 Kg e supporto in plastica</p> <p>Stainless steel base for air-termination rods Ø 42 mm height max 8 meters. Footprint 1850x1850 mm with 6 concrete blocks of 25 Kg and plastic support</p>	

Base a pavimento per aste di captazione Floor base for air-termination rods

Articolo Item	DACB65	
Descrizione Description	Base in acciaio inox 650x650 mm per aste di captazione Ø 42 mm fino ad altezza max 4,25 m, per 4 blocchi in cemento 300x300 mm (non inclusi) Stainless steel base 650x650 mm for air-termination rods Ø 42 mm maximum height 4,25 m, for 4 concrete blocks 300x300 mm (not included)	

Articolo Item	DACM30	DACM36	
Descrizione Description	Blocco in cemento Concrete block	Blocco in cemento Concrete block	
Per aste fino For air-termination rods till	max 3,0 m	max 4,25 m	
Dimensione e peso Dimension and weight	300 x 300 x 60 mm 12 Kg	300 x 300 x 80 mm 16 Kg	

Sistema di ancoraggio e connessione per aste in alluminio Ø 16 mm Anchoring and connection system for aluminium rods Ø 16 mm

Articolo Item	DACF36	
Descrizione Description	Base in cemento 300 x 300 x 80 mm, peso 16 Kg Concrete base 300 x 300 x 80 mm, weight 16 Kg	

Articolo Item	DAPF36	
Descrizione Description	Supporto in plastica per base in cemento 300 x 300 mm Plastic support plate for concrete base 300 x 300 mm	

Il supporto in plastica per base in cemento è necessario su coperture con membrane sintetiche
The support plate for concrete base is necessary on synthetic roofing membranes

Articolo Item	DMA16	
Descrizione Description	Morsetto di giunzione tra asta di captazione Ø 16 mm e conduttore tondo Ø 8 mm, in acciaio INOX Connection clamp between air-termination rod Ø 16 mm and round wire Ø 8 mm, stainless steel	

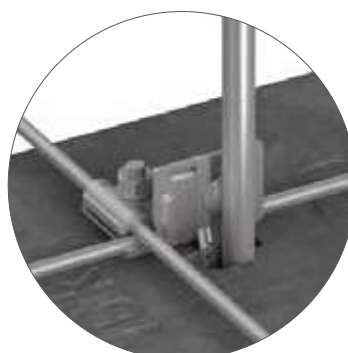

Asta di captazione filettata e astina Air-termination rod and terminal rod

Articolo Item	DAC3100	DAC3150	DAC3200	DAC3250	DSCMA
Altezza asta Rod height	1.000 mm	1.500 mm	2.000 mm	2.500 mm	750 mm
Materiale asta Rod material	Alluminio Aluminium	Alluminio Aluminium	Alluminio Aluminium	Alluminio Aluminium	Alluminio Aluminium
Diametro asta Rod diameter	Ø 16 mm	Ø 16 mm	Ø 16 mm	Ø 16 mm	Ø 10 mm
Riferimento norme Standards compliance	CEI EN 50164-1+2	CEI EN 50164-1+2	CEI EN 50164-1+2	CEI EN 50164-1+2	CEI EN 50164-1+2

Esempi di aste di captazione

- A) Semplice con morsetto per fune
- B) Con morsetto per fune ed astina

Example of air-termination rods

- A) Simple with clamp for steel rope
- B) With rope clamp and rod

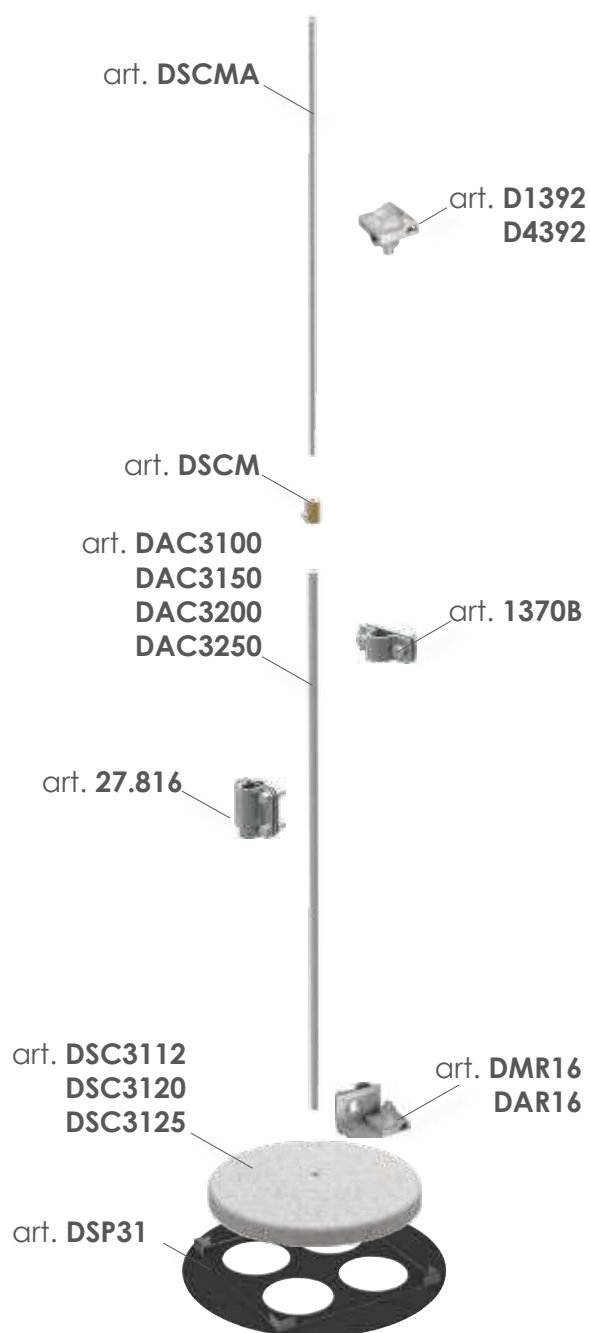
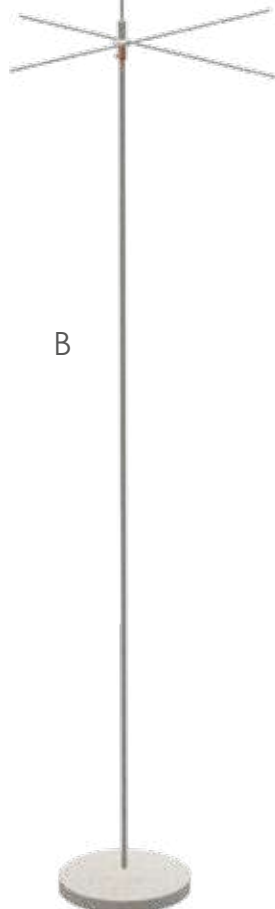
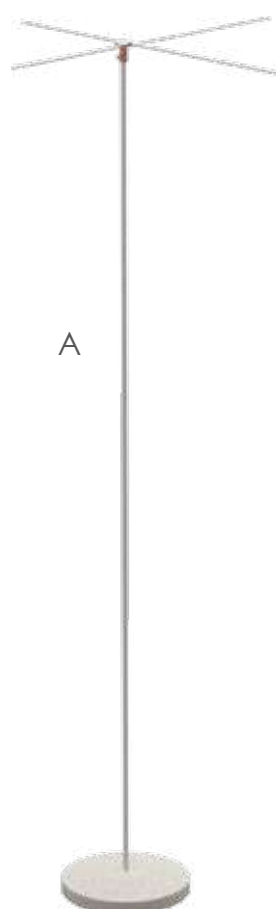

Accessori per asta di captazione filettata in alluminio



Accessories for threaded aluminium air-termination rod

Articolo Item	DSCM		
Descrizione Description	Morsetto di collegamento tra asta e astina Connection clamp between rod and terminal rod		

Articolo Item	D1392	D4392	
Descrizione Description	Morsetto per conduttori tondi Ø 8/10 mm Connection clamp for conductors Ø 8/10 mm		
Materiale Material	Acciaio zincato a caldo Hot galvanized steel	Alluminio Aluminium	
Per conduttori tondi For round conductors	2 x Ø8/10 mm	2 x Ø8/10 mm	

Articolo Item	1370B		
Descrizione Description	Supporto parete in acciaio zincato filettato M8 Wall holder of hot galvanized steel threaded M8		

Articolo Item	27.816		
Descrizione Description	Collegamento tra asta e conduttore tondo o piatto Connection between rod and round or flat conductor		

Articolo Item	DMR16	DAR16	 
Descrizione Description	Morsetto di collegamento tra asta e conduttore tondo Connection clamp between rod and round conductor		
Materiale Material	Alluminio e Acciaio zincato a caldo Aluminium and Hot galvanized Steel	Alluminio e Acciaio Inox Aluminium and Stainless steel	
Per conduttori tondi For round conductors	Ø 8/10 mm	Ø 8/10 mm	
Per aste For rod	Ø 16 mm	Ø 16 mm	

Articolo Item	DSC3112	DSC3120	DSC3125	
Descrizione Description	Base in cemento Concrete base	Base in cemento Concrete base	Base in cemento Concrete base	
Filettatura base Base thread	M16	M16	M16	
Dimensione e peso Dimension and weight	Ø 380 mm 12 Kg	Ø 380 mm 20 Kg	Ø 380 mm 25 Kg	

Articolo Item	DSP31		
Descrizione Description	Supporto in plastica per base in cemento Ø 380 mm Plastic support plate for concrete base Ø 380 mm		

Asta di captazione per tetti ondulati in metallo Air termination rod system for metal undulated roofs

Articolo Item	DAM015
Altezza totale Total height	1.500 mm
Diametro asta/astina Rods diameter	Ø 16/10 mm
Materiale asta Pole material	Acciaio inox Stainless steel
Materiale astina Extension rod material	Alluminio Aluminium
Numero di fissaggi Number of fixing	5 con piastre magnetiche 5 with magnetic plates
Riferimento norme Standards reference	CEI EN 50164-1+2

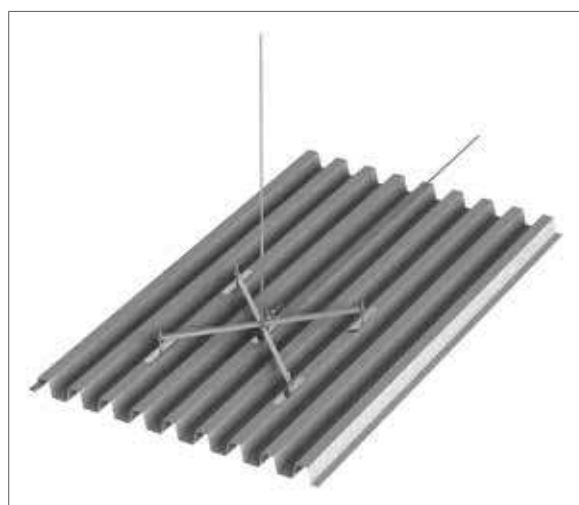

Supporto conduttori per tetto liscio o ondulato Conductor support for flat or undulated roofs

Articolo Item	DSP10IV	
Materiale morsetto Clamp material	Base in Zama, viti in acciaio inox, piastrina in acciaio zincato Base Zamak, stainless steel screws, plate zinc plated steel	
Materiale supporto Support material	Acciaio inox Stainless steel	
Per conduttori tondi For round conductors	Ø 8/10 mm	
Per conduttori piatti For flat conductors	30x4 mm	
Riferimento norme Standards compliance	CEI EN 50164-1+2	

Supporti conduttori per tetti piani

Conductors holders for flat roofs

Articolo Item	393TB	
Dimensioni Dimensions	115 x 95 x 60 mm	
Peso Weight	1,2 Kg	
Materiale supporto Support material	Plastica Plastic	
Blocco base Base block	Cemento Concrete	
Per conduttori tondi For round conductors	2 x Ø 8/10 mm	
Per conduttori piatti For flat conductors	1 x MAX 30x4 mm	
Riferimento norme Standards compliance	UNI EN 1338	

Articolo Item	393.55	
Dimensioni Dimensions	Ø 125 H 55 mm	
Peso Weight	0,150 Kg	
Materiale supporto Support material	Plastica Plastic	
Per conduttori tondi For round conductors	1 x Ø 8/10 mm	
Per conduttori piatti For flat conductors	1 x MAX 30x4 mm	
Riferimento norme Standards compliance	UNI EN 1338	

Articolo Item	393.100	
Dimensioni Dimensions	Ø 125 H 100 mm	
Peso Weight	0,160 Kg	
Materiale supporto Support material	Plastica Plastic	
Per conduttori tondi For round conductors	1 x Ø 8/10 mm	
Per conduttori piatti For flat conductors	1 x MAX 30x4 mm	
Riferimento norme Standards compliance	UNI EN 1338	

Supporti conduttori per coppi Roof conductors holders for ridge tiles

Articolo Item	DSC26RN	DSC26IN	
Regolabile da/a Adjustable from/to	200/350 mm	200/350 mm	
Materiale supporto Holder material	Rame Copper	Acciaio inox Stainless steel	
Per conduttori tondi For round conductors	Ø 8 mm	Ø 8 mm	
Riferimento norme Standards compliance	DIN EN 62561-4	DIN EN 62561-4	

Articolo Item	DSC26RV	DSC26IV	
Regolabile da/a Adjustable from/to	200/350 mm	200/350 mm	
Materiale supporto Holder material	Rame Copper	Acciaio inox Stainless steel	
Per conduttori tondi For round conductors	Ø 8/10 mm	Ø 8/10 mm	
Per conduttori piatti For flat conductors	MAX 30x4 mm	MAX 30x4 mm	
Riferimento norme Standards compliance	DIN EN 62561-4	DIN EN 62561-4	

Supporti conduttori per tegole Roof tiles conductors holders

Articolo Item	DST25RN	DST40RN	
Dimensioni Dimensions	210 x 28 x H30 mm	410 x 28 x H30 mm	
Materiale supporto Holder material	Rame Copper	Rame Copper	
Per conduttori tondi For round conductors	Ø 8 mm	Ø 8 mm	
Riferimento norme Standards compliance	DIN EN 62561-4	DIN EN 62561-4	

Articolo Item	DST25IN	DST40IN	
Dimensioni Dimensions	210 x 28 x H30 mm	410 x 28 x H30 mm	
Materiale supporto Holder material	Acciaio inox Stainless steel	Acciaio inox Stainless steel	
Per conduttori tondi For round conductors	Ø 8 mm	Ø 8 mm	
Riferimento norme Standards compliance	DIN EN 62561-4	DIN EN 62561-4	

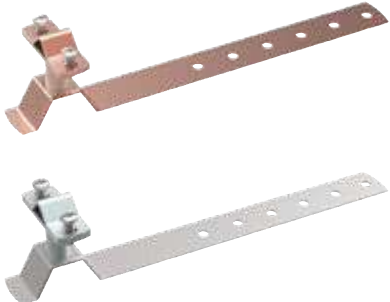
Articolo Item	DST25RV	DST25IV	
Dimensioni Dimensions	210 x 28 x H30 mm	210 x 28 x H30 mm	
Materiale supporto Holder material	Rame Copper	Acciaio inox Stainless steel	
Per conduttori tondi For round conductors	Ø 8/10 mm	Ø 8/10 mm	
Per conduttori piatti For flat conductors	MAX 30x4 mm	MAX 30x4 mm	
Riferimento norme Standards compliance	DIN EN 62561-4	DIN EN 62561-4	

Supporti a parete per conduttori Wall conductors holders

Articolo Item	3370ST	1370ST	
Materiale base Base material	Zama ramata Plated Zamak	Zama Zamak	
Materiale viti Screws material	Acciaio inox Stainless steel	Acciaio inox Stainless steel	
Filettatura base Base thread	M6	M6	
Per conduttori tondi For round conductors	Ø 8/10 mm	Ø 8/10 mm	
Per conduttori piatti For flat conductors	MAX 30x4 mm	MAX 30x4 mm	
Riferimento norme Standards compliance	DIN EN 62561-4	DIN EN 62561-4	

Articolo Item	1370SB	
Materiale base Base material	Zama Zamak	
Materiale viti Screws material	Acciaio inox Stainless steel	
Filettatura base Base thread	M6	
Per conduttori piatti For flat conductors	MAX 30x4 mm	
Riferimento norme Standards compliance	DIN EN 62561-4	

Articolo Item	3005.8	5005.8	
Materiale Material	Rame Copper	Acciaio inox Stainless steel	
Filettatura Thread	M6	M6	
Serraggio a scatto Click clamping	Ø 8 mm	Ø 8 mm	
Riferimento norme Standards compliance	DIN EN 62561-4	DIN EN 62561-4	

Base isolante per supporti 3005.8 e 5005.8 Insulating base for holders 3005.8 and 5005.8

Articolo Item	D3005	D5005	
Materiale Material	Plastica Plastic	Plastica Plastic	
Colore Color	Marrone Brown	Grigio chiaro Light grey	

Supporti a parete con distanziatore Wall conductors holder with spacer

Articolo Item	D420	D520	
Materiale base Base material	Plastica Plastic	Plastica Plastic	
Materiale morsetto Clamp material	ALLUMINIO Aluminium	ACCIAIO INOX Stainless steel	
Altezza Height	20 mm	20 mm	
Per conduttori tondi For round conductors	Ø 8/10 mm	Ø 8/10 mm	
Dimensioni tassello Dowel dimension	Ø 8 mm	Ø 8 mm	
Riferimento norme Standards compliance	DIN EN 62561-4	DIN EN 62561-4	

Distanziatori per supporti filettati Spacers for threaded holders

Articolo Item	D6300	D6500	
Materiale Material	Acciaio zincato Zinc plated steel	Acciaio zincato Zinc plated steel	
Filettatura Thread	M6	M6	
Altezza distanziatori Spacers height	30 mm	50 mm	

Vite per supporti filettati Screw for threaded holders

Articolo Item	DV50M6	
Materiale Material	Acciaio zincato elettrolitico Electrolytic galvanized steel	
Per tassello For dowel	Ø 8 mm	
Dimensione Dimension	6 x 50 mm	
Filettatura testa Head thread	M6	

Morsetti di giunzione Junction clamps

Articolo Item	D3392	D1392	D4392	D5392	
Materiale piastrine Plate material	Rame Copper	Acciaio ZC HG steel	Alluminio Aluminium	Acciaio inox Stainless steel	
Materiale bullone Bolt material	Acciaio ramato Steel copper plated	Acciaio inox Stainless steel	Acciaio inox Stainless steel	Acciaio inox Stainless steel	
Per conduttori tondi For round conductors	2 x Ø8/10 mm	2 x Ø8/10 mm	2 x Ø8/10 mm	2 x Ø8/10 mm	
Riferimento norme Standards compliance	CEI EN 50164-1	CEI EN 50164-1	CEI EN 50164-1	CEI EN 50164-1	

Articolo Item	D327.8	D127.8	D27.8	D527.8	
Materiale piastrine Plate material	Rame Copper	Acciaio ZC HG steel	Acciaio ZC HG steel	Acciaio inox Stainless steel	
Materiale bulloni Bolts material	Acciaio inox Stainless steel	Acciaio inox Stainless steel	Acciaio inox Stainless steel	Acciaio inox Stainless steel	
Struttura Structure	3 piastre 3 plates	3 piastre 3 plates	2 piastre 2 plates	2 piastre 2 plates	
Per conduttori tondi For round conductors	2 x Ø8/10 mm	2 x Ø8/10 mm	2 x Ø8/10 mm	2 x Ø8/10 mm	
Per conduttori piatti For flat conductors	2 x MAX 30 x 4 mm	2 x MAX 30 x 4 mm	2 x MAX 30 x 4 mm	2 x MAX 30 x 4 mm	
Riferimento norme Standards compliance	CEI EN 50164-1	CEI EN 50164-1	CEI EN 50164-1	CEI EN 50164-1	

Morsetti di giunzione bimetallici Bimetal junction clamps

Articolo Item	D6392	D648	
Materiale piastrine Plate material	Alluminio / Rame Aluminium / Copper	Alluminio / Rame Aluminium / Copper	
Struttura Structure	3 piastre 3 plates	3 piastre 3 plates	
Per conduttori tondi For round conductors	2 x Ø 8/10 mm	1 x Ø 8/10 mm	
Per conduttori piatti For flat conductors	-	1 x MAX 30 x 4 mm	
Riferimento norme Standards compliance	CEI EN 50164-1	CEI EN 50164-1	

Morsetti di collegamento per gronde

Gutter channels connecting clamps

Articolo Item	D3382	D1382	
Materiale morsetto Clamp material	Rame Copper	Acciaio zincato Galvanized steel	
Materiale viti Screws material	Acciaio ramato Copper-plated steel	Acciaio inox Stainless steel	
Per conduttori tondi For round conductors	1 x Ø 8/10 mm	1 x Ø 8/10 mm	
Riferimento norme Standards reference	CEI EN 50164-1	CEI EN 50164-1	

Morsetti di collegamento per lamiera

Connection clamps for metal sheets

Articolo Item	D3334	D1334	
Campo di serraggio Clamping range	1/5 mm	1/5 mm	
Materiale morsetto Clamp material	Rame Copper	Acciaio zincato Galvanized steel	
Materiale viti Screws material	Acciaio ramato Copper-plated steel	Acciaio inox Stainless steel	
Per conduttori tondi For round conductors	1 x Ø 8/10 mm	1 x Ø 8/10 mm	
Riferimento norme Standards compliance	CEI EN 50164-1	CEI EN 50164-1	

Articolo Item	D1384	
Campo di serraggio Clamping range	5/18 mm	
Materiale morsetto Clamp material	Acciaio zincato a caldo Hot galvanized steel	
Per conduttori tondi For round conductors	1 x Ø 8/10 mm	
Riferimento norme Standards compliance	CEI EN 50164-1	

Collare per tubi pluviali

Downpipe collar

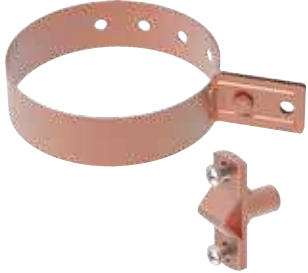
Articolo Item	DCP612	DCP915	DM1211	
Descrizione Description	Collare per Collar for Ø 60/120 mm	Collare per Collar for Ø 90/150 mm	Morsetto per Clamp for 1 x Ø 8/10 mm	
Materiale Material	Rame Copper	Rame Copper	Rame Copper	
Riferimento norme Standards compliance	CEI EN 50164-1	CEI EN 50164-1	CEI EN 50164-1	

Morsetti di giunzione Junction clamps

Articolo Item	DC132	
Materiale piastrine Plate material	Acciaio zincato a caldo Hot galvanized steel	
Materiale viti Screws material	Acciaio inox Stainless steel	
Struttura Structure	3 piastre 3 plates	
Per conduttori tondi For round conductors	1 x Ø 8/10 mm	
Per conduttori piatti For flat conductors	1 x MAX 30x4 mm	
Riferimento norme Standards compliance	CEI EN 50164-1	

Articolo Item	DC813	
Materiale piastrine Plate material	Acciaio zincato a caldo Hot galvanized steel	
Materiale viti Screws material	Acciaio zincato a caldo Hot galvanized steel	
Struttura Structure	2 piastre 2 plates	
Per conduttori tondi For round conductors	2 x Ø 8/10 mm	
Riferimento norme Standards compliance	CEI EN 50164-1	

Articolo Item	DC1376	
Materiale piastrine Plate material	Rame nichelato Nickel plated copper	
Materiale viti Screws material	Acciaio inox Stainless steel	
Dimensioni Dimensions	Ø 18 x 75 mm	
Per conduttori tondi For round conductors	2 x Ø8/10 mm	
Riferimento norme Standards compliance	CEI EN 50164-1	

Articolo Item	D392	
Materiale piastrine Plate material	Acciaio inox Stainless steel	
Materiale bullone Support material	Acciaio inox Stainless steel	
Dimensioni Dimensions	75 x 32 mm	
Per conduttori tondi For round conductors	2 x Ø 8/10 mm	
Riferimento norme Standards compliance	CEI EN 50164-1	

Morsetti di collegamento per ferri d'armatura

Connection clamps for reinforcing bars

Articolo Item	DFA620	
Materiale Material	Acciaio zincato Galvanized steel	
Per conduttori tondi For round conductors	1 X Ø 8/10 mm	
Per conduttori piatti For flat conductors	1 X 30 x 3,5 mm	
Per ferri d'armatura For reinforcing bars	1 X Ø 6/20 mm	
Riferimento norme Standards compliance	CEI EN 50164-1	

Punto fisso di terra con astina di collegamento

Fixed earthing terminal

Articolo Item	DPF112	
Materiale Material	Acciaio inox Stainless steel	
Dimensione piastra Plate dimension	Ø 80 mm	
Fori su piastra Plate mounting holes	3 x Ø4 mm	
Dimensione astina Rod dimension	Ø 10 x 190 mm	
Filetto di connessione Connection thread	M10	
Riferimento norme Standards compliance	CEI EN 50164-1	

Morsetto di collegamento multifunzione

Multi connection clamp

Articolo Item	D1393	
Materiale Material	Acciaio zincato Galvanized steel	
Struttura Structure	3 piastre 75x75 mm 3 plates 75x75 mm	
Parte superiore Upper part	1 x Ø 8/16 mm 1 x Ø15/32 mm	
Parte inferiore Bottom part	1 x Ø 8/16 mm 1 x Ø15/27 mm	
Riferimento norme Standards compliance	DIN EN 62561-2	

Sistema parafulmine con componenti speciali Lightning protection system with special components

Il sistema con tenditore a molla è semplice, innovativo e sicuro, ideato per risolvere le difficoltà durante l'installazione di un impianto di parafulmine su campanili, castelli e torri, dove è difficile installare i supporti per i conduttori in calata. Questo sistema è particolarmente apprezzato per la velocità e la facilità di applicazione, soprattutto in luoghi difficili da raggiungere con i ponteggi tradizionali. Qui sotto potete vedere alcuni esempi di applicazioni effettuate su strutture storiche in collaborazione con la Soprintendenza Archeologia Belle Arti e Paesaggio per le province di Siena, Grosseto e Arezzo.

The wire compensator system is simple, innovative and safe, it has been thought in order to solve the problems during the installation of a lightning protection system on bell towers, castles and towers, where it is difficult to install the wire holder. This system is appreciated above all because it is fast and easy to apply, above in those places which are difficult to reach with the traditional scaffoldings. Below you can see some examples of applications carried out on historical structures in collaboration with the Superintendency of Archeology, Fine Arts and Landscape for the provinces of Siena, Grosseto and Arezzo.



Monastero di San Rabano (GR)
Monastery of San Rabano (GR)



Castello delle Saline (GR)
Saline Castle (GR)



Polveriera Guzman (GR)
Guzman powder magazine (GR)



Castello Silvana (GR)
Silvana Castle (GR)



Castello del Giglio (GR)
Castle of Giglio (GR)

Sistema con tenditore a molla System with tensioner

Il sistema con tenditore del conduttore è un'applicazione suggerita per strutture di interesse storico, dove in molti casi è impossibile raggiungere il tetto perchè è impossibile applicare un'impalcatura esterna a causa del terreno scosceso o di mura inclinate, ed in molti casi non sono presenti scale interne. In questo caso viene utilizzato un elicottero che porta l'operatore sul tetto il quale applicherà in maniera rapida la staffa di giunzione sul colmo della torre e calerà il conduttore fino a terra fissandolo poi al tenditore mettendolo in tensione grazie ad una molla al suo interno. Questo sistema inoltre richiede pochissima manutenzione perchè la molla del tenditore gestisce in maniera autonoma le dilatazioni del conduttore che avvengono con il cambio di stagione mantenendolo sempre in tensione. Un sistema tradizionale invece richiede una manutenzione assidua, almeno una volta l'anno bisogna effettuare un controllo per visionare che i conduttori in calata siano sempre ben tesi evitando il contatto con la parete. In collaborazione con le Belle Arti abbiamo studiato e messo in protezione molti edifici, torri, roccaforti dell'arcipelago Toscano che si trovano in posizioni critiche e pericolose per l'operatore. Siamo perciò intervenuti con un sistema innovativo e funzionale portando un notevole risparmio economico ed una diminuzione di rischio al cliente finale.

The conductor tensioner system is a suggested application for structures of historical interest, where in many cases it is impossible to reach the roof because it is impossible to apply an external scaffold due to the steep ground or inclined walls, and in many cases there are not internal stairs. In this case, a helicopter is used that brings the operator to the roof which will quickly apply the junction bracket to the top of the tower and lower the conductor to the ground, then fixing it to the tensioner by putting it under tension thanks to a spring inside. This system also requires very little maintenance because the tensioner spring independently manages the expansions of the conductor that take place with the change of season, keeping it always in tension. A traditional system, on the other hand, requires constant maintenance, at least once a year, a check must be carried out to see that the conductors in the descent are always well stretched, avoiding contact with the wall. In collaboration with the Fine Arts, we have studied and protected many buildings, towers, strongholds of the Tuscan archipelago, which being in critical and dangerous positions for the operator, we intervened with an innovative and functional system, bringing a significant economic saving and a decrease of risk to the end customer.



Sistema tradizionale
Traditional system

Sistema con tenditore
System with tensioner

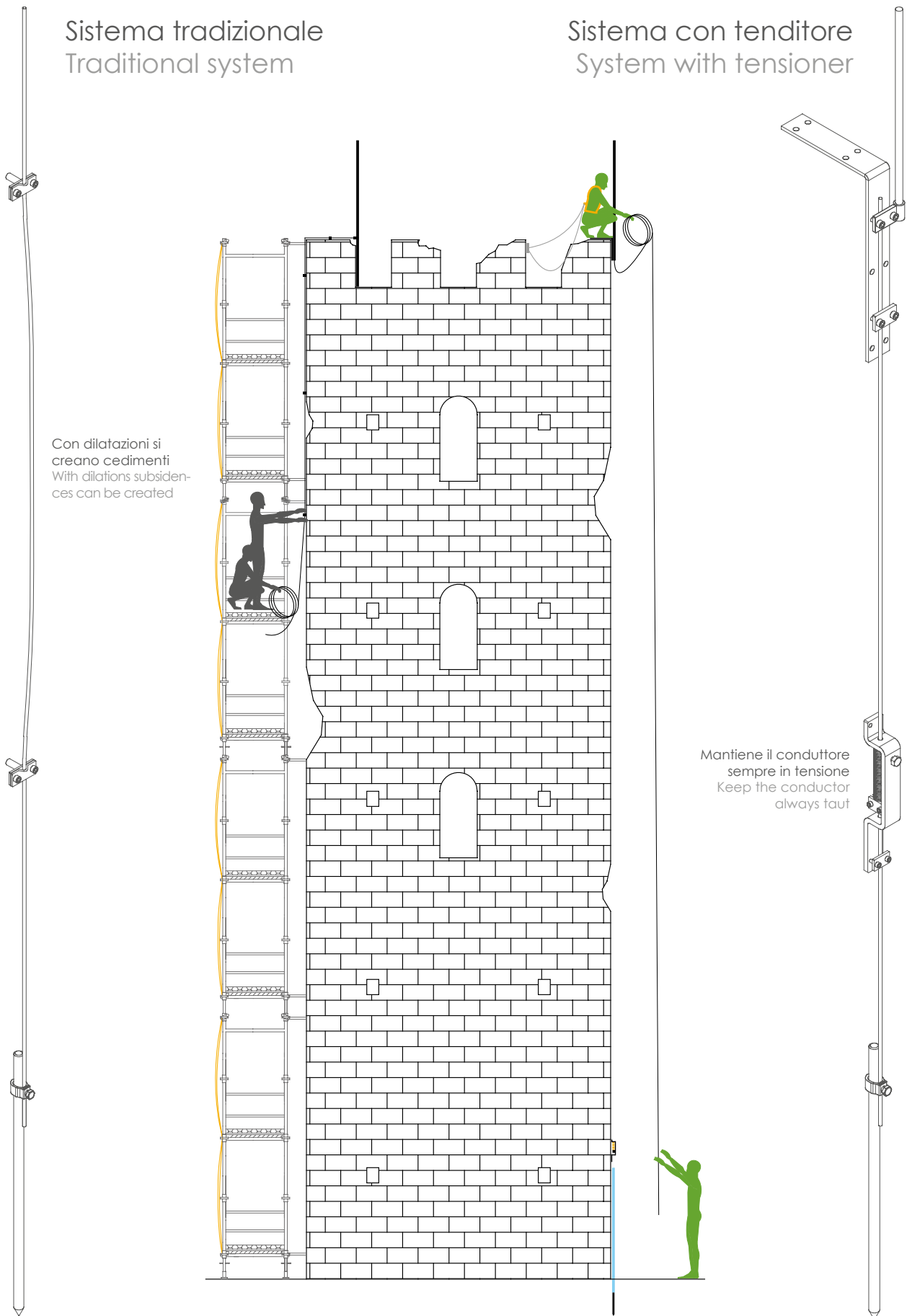



Componenti speciali con tenditore a molla Special components with wire compensator

Articolo Item	DAC10.I		
Descrizione Description	Asta di captazione Air-termination rod		
Materiale Material	Acciaio inox Stainless steel		
Fori fissaggio Fixing holes	Ø 8 mm		
Dimensione Dimension	Ø 10 mm x 0,75 m		

Articolo Item	DSG.R	DSG.I	
Descrizione Description	Staffa di giunzione lineare Linear junction holder	Staffa di giunzione lineare Linear junction holder	
Materiale Material	Rame e acciaio inox Copper / stainless steel	Acciaio inox Stainless steel	
Fori fissaggio Fixing holes	Ø 8 mm	Ø 8 mm	
Per conduttori tondi For round conductors	Ø 8/10 mm	Ø 8/10 mm	

Articolo Item	DSGL.R	DSGL.I	
Descrizione Description	Staffa di giunzione a L L junction holder	Staffa di giunzione a L L junction holder	
Materiale Material	Rame e acciaio inox Copper and stainless steel	Acciaio inox Stainless steel	
Fori fissaggio Fixing holes	Ø 8 mm	Ø 8 mm	
Per conduttori tondi For round conductors	Ø 8/10 mm	Ø 8/10 mm	

Articolo Item	DTC.R	DTC.I	
Descrizione Description	Tenditore per calate Wire compensator for downlead	Tenditore per calate Wire compensator for downlead	
Materiale Material	Rame e acciaio inox Copper and stainless steel	Acciaio inox Stainless steel	
Fori fissaggio Fixing holes	Ø 8 mm	Ø 8 mm	
Per conduttori tondi For round conductors	Ø 8/10 mm	Ø 8/10 mm	

Articolo Item	DTCU		
Descrizione Description	Utensile per il caricamento del tenditore Tool for loading the tensioner		
Materiale Material	Acciaio inox Stainless steel		

Articolo Item	Pagina Page	Articolo Item	Pagina Page	Articolo Item	Pagina Page	Articolo Item	Pagina Page	Articolo Item	Pagina Page		
A		AF3.015	288	AGS9	299	ANEF3.015	276	AT10.M5	297		
		AF3.015ASB	288	AGT30.M12	298	ANEF3.020	276	AT5.M4	297		
		AF3.020	288	AGT30.M5	298	ANERO	303	AT6.M5	297		
		AF3.020ASB	288	AGT53.M12	298	ANF4.005	277	AT8.M5	297		
		AF3.021MAX	289	AI3.010	282	ANF4.010	277	ATG06	296		
		AF3.030	288	AI3.015	282	ANF4.015	277	AV1000	301		
		AF3.030ASB	288	AI3.015ASB	282	ANF4.020	277	AV350	301		
		AF35.010	290	AI3.020	282	ANF4.025	277	AV550	301		
		AF35.015	290	AI3.020ASB	282	ANF4.030	277	AV600	301		
		AF35.020	290	AI3.025	282	AP10.M5	296	AV850	301		
		AF35.025	290	AI3.030	282	AP13.M5	296	AVERDE	303		
		AF45.015	290	AI3.030ASB	282	AP14.M12	296	B			
		AF45.030	290	AI6.015	283	AP4.010	278				
		AF6.030	291	AI6.020	283	AP4.015	278			B100	226
		AF6.040	291	AI6.020CA	283	AP4.015ASB	278			B100.1	226
		AF6.040C550	291	AI6.030	283	AP4.020	278			B102	228
		AF6.050	291	AI6.030CA	283	AP4.020ASB	278			B103.2	64
		AF6.050C550	291	AI6.040	283	AP4.025	278			B103.3	64
		AF6.060	291	AI6.040CA	283	AP4.030	278			B103.AL	66
		AF6.060C550	291	AI6.050	283	AP4.030ASB	278			B103.CL	66
AF6.080	291	AI6.050CA	283	AP6.M5	296	B103.FR	66				
AF6.080C550	291	AI6.060	283	AP8.M5	296	B103.WG	66				
AF6.100	291	AI6.060CA	283	APAV.3	76	B104	236				
AF6.100C550	291	AKP72.3	76	APES.3	77	B106	236				
AF9.040C700	292	AL6.M5.1	298	APIV.3	76	B110	236				
AF9.050	292	AL6.M5.3	298	APR7.M5	296	B116	236				
AF9.050C700	292	ALUB	303	APR9.M5	296	B125	236				
AF9.050C720	292	AM45.010	280	APS4KIT	296	B15	226				
AF9.060	292	AM45.015	280	APS5.M4	296	B15.1	226				
AF9.060C700	292	AM45.015ASB	280	APS5KIT	296	B160	226				
AF9.060C720	292	AM45.020	280	APS6.M5	296	B162	228				
AF9.080	292	AM45.020ASB	280	APS6KIT	296	B163	229				
AF9.080C700	292	AM45.025	280	APS8.M5	296	B165	229				
AF9.080C720	292	AM45.030	280	APT4KIT	296	B204	232				
AF9.100	292	AM45.030ASB	280	APT5.M4	296	B204S	235				
AF9.100C850	292	AM5.010	278	APT5KIT	296	B206	232				
AF9.150	292	AM5.015	278	APT6.M5	296	B206S	235				
AF9.150C850	292	AM5.015ASB	278	APT6KIT	296	B210	232				
AFS4.010	294	AM5.020	278	APT8.M5	296	B2104	237				
AFS4.015	294	AM5.020ASB	278	APUG503.3	77	B2106	232				
AFS4.015ASB	294	AM5.030	278	APUG505.3	77	B210S	235				
AFS4.020	294	AM5.030ASB	278	APVS.3	77	B2110	232				
AFS4.020ASB	294	AM6.010	281	APWL.3	76	B2116	232				
AFS4.030	294	AM6.015	281	APWT.3	77	AR30.M12	297				
AFS4.030ASB	294	AM6.020	281	APWTA.3	76	AR30.M5	297				
AFS6.015	295	AM6.025	281	AR30.M12	297	AR53.M12	297				
AFS6.020	295	AM6.030	281	ARI030	297	ARI060	297				
AFS6.030	295	AM6.030C350	281	ARIA	303	ARM030	297				
AFS6.030CA	295	AM6.040	281	ARM045	297	ARM060	297				
AFS6.040	295	AM6.040C350	281	AROSSO	303	ASB	301				
AFS6.040CA	295	AM6.050	281	ASBL	303	ASFWL.3	77				
AFS6.050	295	AM6.050C350	281	ASFWR.3	77	ASPO64L.3	77				
AFS6.050CA	295	AM6.060	281	ASR11	299	ASR11	299				
AFS6.060	295	AM6.060C350	281	ASR30	299	ASR35	299				
AFS6.060CA	295	AMF3.005	279	ASR45	299	ASR6	299				
AGE050	302	AMF3.010	279	ASR9	299	AST11	299				
AGE1	302	AMF3.015	279	AST30	299	AST35	299				
AGF400	302	AMF3.015ASB	279	AST35	299	AST45	299				
AGFM5.M5	297	AMF3.020	279	AST6	299	AST9	299				
AGI050	302	AMF3.020ASB	279	AST9	299						
AGI1	302	AN4.005	277								
AGI5	302	AN4.010	277								
AGL050	302	AN4.015	277								
AGL1	302	AN4.020	277								
AGL5	302	AN4.025	277								
AGM12.M12	297	AN4.030	277								
AGM5.M5	297	ANE4.005	276								
AGS11	299	ANE4.010	276								
AGS30	299	ANE4.015	276								
AGS35	299	ANE4.020	276								
AGS45	299	ANEF3.005	276								
AGS6	299	ANEF3.010	276								

Articolo Item	Pagina Page	Articolo Item	Pagina Page	Articolo Item	Pagina Page	Articolo Item	Pagina Page	Articolo Item	Pagina Page		
CA702	262	CSR16	339	D40.114	393	DFM10	402	EPCX10	268		
CA721/10	262	CSR20	339	D40.12	393	DFR10	402	EPCX2.5	268		
CA721/2	262	CSR25	339	D40.34	393	DFT10	402	EPCX4	268		
CA721/3	262	CSR32	339	D40.38	393	DHVC28	398	EPCX6	268		
CA721/4	262	CSR40	339	D420	415	DM05.1	394	EPCXDL2.5	271		
CA722/10	262	CSR50	339	D4392	416	DM05.2	394	EPUSC	267		
CA722/2	262	CTL2.5U	266	D5005	414	DM08.1	394	F			
CA722/3	262	CTL2.5UBU	266	D520	415	DM08.2	394				
CA722/4	262	CTRIWER	148	D527.8	416	DM08.2BL	394				
CA723/10	262	CTS10U	262	D5392	416	DM12.2	394				
CA723/2	262	CTS10UBU	262	D6300	415	DM1211	417		F1000125	328	
CA723/3	262	CTS16U	263	D6392	416	DM14.2	394		F1000125N	328	
CA723/4	262	CTS16UBU	263	D648	416	DMA16	407		F10025	328	
CA724/10	262	CTS2.5UN	262	D6500	415	DMC315	392		F10025I	328	
CA724/2	262	CTS2.5UNBU	262	DABI030	403	DMC515	392		F10025IN	328	
CA724/3	262	CTS25UN	263	DABI035	403	DMF18	390		F10025N	328	
CA724/4	262	CTS25UNBU	263	DABI040	403	DML18	390		F12048	328	
CA725/10	263	CTS35UN	263	DABI045	403	DMR16	409		F12048N	328	
CA725/2	263	CTS35UNBU	263	DABI050	403	DMTI	391		F14025	328	
CA725/3	263	CTS4UN	262	DABI055	403	DP315	392		F14025I	328	
CA725/4	263	CTS4UNBU	262	DABI060	403	DPF112	419		F14025IN	328	
CA751/10	263	CTS50/70N	263	DABI070	403	DPF28	405		F14025N	328	
CA751/2	263	CTS50/70NBU	263	DABI080	403	DPT28	400		F14036	328	
CA751/3	263	CTS6U	262	DAC030	404	DS22	394		F14036N	328	
CA751/4	263	CTS6UBU	262	DAC040	404	DSC26IN	412		F16025	328	
CA771/10	263	CTS95/120N	263	DAC050	404	DSC26IV	412	F16025N	328		
CA771/2	263	CTS95/120NBU	263	DAC060	404	DSC26RN	412	F16048	328		
CA771/3	263	CX10	268	DAC070	404	DSC26RV	412	F16048N	328		
CA771/4	263	CX10BU	268	DAC080	404	DSC3112	409	F20025	328		
CA802	262	CX2.5	268	DAC10.I	423	DSC3120	409	F20025I	328		
CB1333A3	114	CX2.5BU	268	DAC3100	408	DSC3125	409	F20025IN	328		
CB1333AA	114	CX4	268	DAC3150	408	DSCM	409	F20025N	328		
CB1333VA	114	CX4BU	268	DAC3200	408	DSMA	408	F20036	328		
CB1333VN	114	CX6	268	DAC3250	408	DSG.I	423	F20036N	328		
CB1384A3	114	CX6BU	268	DACB1	406	DSG.R	423	F20036S	328		
CB1384AA	114	CXDL2.5	271	DACB2	406	DSGL.I	423	F20048	328		
CB1384VA	114	CXDL2.5BU	271	DACB3	406	DSGL.R	423	F20048N	328		
CB1384VN	114	CXF4	270	DACB65	407	DSP10IV	410	F20076	328		
CBF200A3	116	CXF4L110-240V	270	DACF36	407	DSP31	409	F20076N	328		
CBF200AA	116	CXF4L6-60V	270	DACI3300	405	DST25IN	413	F25048	328		
CBF200VN	116	CXG10	269	DACI3350	405	DST25IV	413	F25048N	328		
CDL4UN	266	CXG2.5	269	DACI3400	405	DST25RN	413	F25076	328		
CDL4UNBU	266	CXG4	269	DACI3450	405	DST25RV	413	F25076N	328		
CDP30A3	110	CXG6	269	DACI3500	405	DST28	400	F29036	328		
CDP30AA	110	D		DACI3550	405	DST40IN	413	F29036I	328		
CDP30VA	110				DACM30	407	DST40RN	413	F29036IN	328	
CDP30VN	110				DACM36	407	DTC.I	423	F29036N	328	
CDP50A3	110				DAM015	410	DTC.R	423	F29048	328	
CDP50AA	110		D1053	397	DAPF36	407	DTCU	423	F29048N	328	
CDP50VA	110		D105A	397	DAR16	409	DTSP	406	F30076	328	
CDP50VN	110		D105R	397	DASF	406	DV50M6	415	F30076N	328	
CDP70A3	110		D127.8	416	DASP	406	E		F36036	328	
CDP70AA	110		D1334	417	DB18	390				F36036N	328
CDP70VA	110		D1382	417	DB20	392				F36048	328
CDP70VN	110		D1384	417	DC132	418				F36048I	328
CF4U	265		D1392	416	DC1376	418		EDK3035.3	82	F36048IN	328
CF4UBU	265		D1393	419	DC813	418		EDK4050.3	82	F36048N	328
CF4UL110-240V	265		D27.8	416	DCA28	399		EDK503.3	82	F36076	328
CF4UL6-60V	265		D3005	414	DCE28	401		EDKA35.3	82	F36076N	328
CGT10N	264		D327.8	416	DCF28	399		EDKA50.3	82	F39048	328
CGT16N	264		D3334	417	DCP28	400		EDKB100.3	82	F39048N	328
CGT35U	264		D3382	417	DCP612	417		EDKB70.3	82	F43048	328
CGT4N	264		D3392	416	DCP915	417		EDKD35.3	82	F43048N	328
CGT4U	264	D36.1	393	DCS28	400	EDKD50.3		82	F45076	328	
CGT6N	264	D37.0	393	DCT2020	388	EDKE35.3		82	F45076N	328	
CHV10U	267	D37.1	393	DCT2030CN	388	EDKE50.3		82	F500125	328	
CHV4U	267	D37.4	393	DCT28	401	EDKI35.3		82	F500125N	328	
CHV6U	267	D37.6	393	DCU28	399	EDKI50.3		82	F54076	328	
CS12	68	D392	418	DFA04	402	EP2.5/4UN		262	F54076N	328	
CS40.2	115	D40.01	393	DFA06	402	EP6/10U		262	F720125	328	
CS40.3	115	D40.02	393	DFA10	402	EPCDL4UN	266	F720125N	328		
CS40.AL	115	D40.112	393	DFA620	419	EPCTL2.5U	266	F75076	328		

Articolo Item	Pagina Page
F75076N	328
F78090	328
F78090N	328
F850125	328
F850125N	328
FI18090N	329
FI26090N	329
FI36090N	329
FS0825	329
FS3250	329
FSA1919	329
FSA1919N	329
FSA2727	329
FSA2727N	329
FSV1595	329
FSV1595N	329
FSV2216	329
FSV2216N	329
FT10025	328
FT20025	328
FT640	330
FT640N	330
FTS10025	328
FTS1550	330
FTS20025	328
FUP95	330

G

GA012	215
GA022	215
GA033	215
GA040	215
GA055	215
GA065	215
GA072	215
GA092	215
GA115	215
GA180	215
GC16	339
GC20	339
GC25	339
GC32	339
GCS16	339
GCS20	339
GCS25	339
GCS32	339
GGB05PE	205
GGB10PE	205
GGB15PE	205
GGB20PE	205
GGB25PE	205
GGB30PE	205
GGB40PE	205
GGB50PE	205
GHL1620S	217
GHL1920E	217
GI-BOX100	316
GI-BOX80	316
G-KIT	216
G-KIT1	216
GLB030	312
GLB1	312
GL-BOX100	316
GM032YV	215
GM048YV	215
GM064YV	215
GM095YV	215
GM127YV	215
GM190YV	215
GM254YV	215

Articolo Item	Pagina Page
GNB05PE	205
GNB10PE	205
GNB15PE	205
GNB20PE	205
GNB25PE	205
GNB30PE	205
GNB40PE	205
GNB50PE	205
GPB050	314
GS10	338
GS12	338
GS12N	338
GS14	338
GS16	338
GS16-10	338
GS16N	338
GS20	338
GS20-10	338
GS20N	338
GS22	338
GS25	338
GS25-10	338
GS25N	338
GS32	338
GS32N	338
GS40	338
GS40N	338
GS50	338
GS50N	338
GS60	338
GSB030	306
GSB030B	306
GSB030BL	306
GSB040BL	306
GSB1	306
GSB10	306
GSM030	308
GSM1	308
GSM250	310
GSM280	310
GSR025	304
GSR050	304
GTB024	214
GTB024N	214
GTB024T	214
GTB024YV	214
GTB032	214
GTB032N	214
GTB032T	214
GTB032YV	214
GTB048	214
GTB048N	214
GTB048T	214
GTB048YV	214
GTB064	214
GTB064N	214
GTB064T	214
GTB064YV	214
GTB095	214
GTB095N	214
GTB095T	214
GTB095YV	214
GTB127	214
GTB127N	214
GTB127T	214
GTB127YV	214
GTB190	214
GTB190N	214
GTB190T	214
GTB190YV	214
GTB254	214
GTB254N	214

Articolo Item	Pagina Page
GTB254T	214
GTB254YV	214
GTB381	214
GTB381N	214
GTB381T	214
GTB381YV	214
GTB508	214
GTB508N	214
GTB508T	214
GTB508YV	214
GTM012	212
GTM012N	212
GTM012R	212
GTM012T	212
GTM012W	212
GTM012Y	212
GTM016	212
GTM016N	212
GTM016R	212
GTM016T	212
GTM016W	212
GTM016Y	212
GTM024	212
GTM024N	212
GTM024R	212
GTM024T	212
GTM024W	212
GTM024Y	212
GTM032	212
GTM032N	212
GTM032R	212
GTM032T	212
GTM032W	212
GTM032Y	212
GTM048	212
GTM048N	212
GTM048R	212
GTM048T	212
GTM048W	212
GTM048Y	212
GTM064	212
GTM064N	212
GTM064R	212
GTM064T	212
GTM064W	212
GTM064Y	212
GTM095	212
GTM095N	212
GTM095R	212
GTM095T	212
GTM095W	212
GTM095Y	212
GTM127	212
GTM127N	212
GTM127R	212
GTM127T	212
GTM127W	212
GTM127Y	212
GTM190	212
GTM190N	212
GTM190R	212
GTM190T	212
GTM190W	212
GTM190Y	212
GTM254	212
GTM254N	212
GTM254R	212
GTM254T	212
GTM254W	212
GTM254Y	212
GTR40-1	30
GTR60-1	30

Articolo Item	Pagina Page
GTR80-1	30
GTS012-BL	213
GTS016-BL	213
GTS024-BL	213
GTS024BR-BL	213
GTS024GR-BL	213
GTS024N-BL	213
GTS024R-BL	213
GTS024T-BL	213
GTS024YV-BL	213
GTS032-BL	213
GTS032N-BL	213
GTS032R-BL	213
GTS048-BL	213
GTS048BR-BL	213
GTS048GR-BL	213
GTS048N-BL	213
GTS048R-BL	213
GTS048T-BL	213
GTS048YV-BL	213
GTS064-BL	213
GTS064N-BL	213
GTS064R-BL	213
GTS095-BL	213
GTS095BR-BL	213
GTS095GR-BL	213
GTS095N-BL	213
GTS095R-BL	213
GTS095T-BL	213
GTS095YV-BL	213
GTS127-BL	213
GTS127BR-BL	213
GTS127GR-BL	213
GTS127N-BL	213
GTS127R-BL	213
GTS127T-BL	213
GTS127YV-BL	213
GTS190-BL	213
GTS190BR-BL	213
GTS190GR-BL	213
GTS190N-BL	213
GTS190R-BL	213
GTS254-BL	213
GTS254BR-BL	213
GTS254GR-BL	213
GTS254N-BL	213
GTS254R-BL	213
GTS381-BL	213
GTS381BR-BL	213
GTS381GR-BL	213
GTS508-BL	213
GUG	216
GUP	216

J

JX2.5/10	268
JX2.5/2	268
JX2.5/3	268
JX2.5/4	268
JX2.5/8	268
JX4/10	268
JX4/2	268
JX4/3	268
JX4/4	268
JX4/8	268
JX6/10	268
JX6/2	268
JX6/3	268
JX6/4	268

K

K040120.3	32
K04060.3	32
K04080.3	32
K060100.3	32
K06060.3	32
K06080.3	32
K1010.3	12
K1022.1	12
K1022.3	12
K1022.5	12
K1022.52	16
K1022.53	16
K1022BL.3	14
K103	64
K1031.3	12
K104	64
K1515.1	12
K1515.3	12
K1515.5	12
K1515BL.3	14
K1818.3	12
K1818BL.3	14
K1825.3	12
K1825BL.3	14
K1830.1	12
K1830.3	12
K1830.5	12
K1830BL.3	14
K1831.3	12
K1831.52	16
K1831.53	16
K1831BL.3	14
K1841.3	12
K1841BL.3	14
K1852.3	12
K2530.1	12
K2530.3	12
K2530BL.3	14
K2540.3	12
K2540BL.3	14
K2541.3	12
K2541BL.3	14
K3030.3	12
K40100.1	30
K40100.3	30
K40120.3	30
K4040.1	12
K4040.3	12
K4040.5	12
K4040BL.3	14
K4060.1	30
K4060.3	30
K4060.8	30
K4080.1	30
K4080.3	30
K60100.1	30
K60100.3	30
K60120.1	30
K60120.3	30
K60150.1	30
K60150.3	30
K60200.1	30
K60200.3	30
K60250.1	30
K60250.3	30
K6060.1	30
K6060.3	30
K6080.1	30

Articolo Item	Pagina Page	Articolo Item	Pagina Page	Articolo Item	Pagina Page	Articolo Item	Pagina Page	Articolo Item	Pagina Page
K6080.3	30	KC57	25	KI1830.5	12	KP660	34	KT40100R.3	31
K686H80	34	KC81	25	KI1830.52	16	KPA100.2	70	KT40120.3	31
K72	64	KC91	25	KI1830.53	16	KPA100.3	70	KT40120R.3	31
K80100.3	30	KCF100-53.3	34	KI1830V.3	12	KPA100.AL	70	KT4040.3	13
K80120.3	30	KCF120-05.3	34	KI1840V.3	12	KPA100.CL	70	KT4060R.1	31
K80150.1	30	KCF120-53.3	34	KI1850.3	12	KPA100.FR	70	KT4060R.3	31
K80150.3	30	KCF120-D1.3	34	KI2530.3	12	KPA100.WG	70	KT4080R.1	31
K80200.1	30	KCF150-05.3	34	KI2530V.3	12	KPA1873.3	89	KT4080R.3	31
K80200.3	30	KCF150-53.3	34	KI2540.3	12	KPA1873A	89	KT60100.1	31
KA1010.3	13	KCF150-D1.3	34	KI2540V.3	12	KPA70.2	70	KT60100.3	31
KA1015.3	25	KCF200-53.3	34	KI3030V.3	12	KPA70.3	70	KT60100R.1	31
KA1015.CL	25	KCF80-53R.3	34	KI40100.1	31	KPA70.AL	70	KT60100R.3	31
KA1015.FG	25	KDP60250	37	KI40100.3	31	KPA70.CL	70	KT60120.1	31
KA1022.3	13	KDU1022.3	16	KI40100V.3	30	KPA70.FR	70	KT60120.3	31
KA1022.5	13	KDU1030.3	16	KI40120V.3	30	KPA70.WG	70	KT60150.1	31
KA1022.52	16	KDU1818.3	16	KI4040.3	12	KPD.1	88	KT60150.3	31
KA1022.53	16	KDU1830.3	16	KI4040V.3	12	KPD.2	88	KT60200.1	31
KA1030.3	13	KDU1831.3	16	KI4060.1	31	KPD.3	88	KT60200.3	31
KA1515.3	13	KDU1851.3	16	KI4060.3	31	KPD.AL	88	KT60250.1	31
KA1818.3	13	KE100.1	31	KI4060V.3	30	KPE1873A	89	KT60250.3	31
KA1825.3	13	KE100.3	31	KI4080.1	31	KPI1873.3	89	KT6060R.1	31
KA1830.3	13	KE1010.3	13	KI4080.3	31	KPI1873A	89	KT6060R.3	31
KA1830.5	13	KE1015.3	25	KI4080V.3	30	KPS72.3	76	KT6080R.1	31
KA1830.52	16	KE1015.CL	25	KI60100.1	31	KPV35.1	88	KT6080R.3	31
KA1830.53	16	KE1015.FG	25	KI60100.3	31	KPV35.3	88	KT80100.3	31
KA1830V.3	12	KE1022.3	13	KI60100V.3	30	KPV50.1	88	KT80120.3	31
KA1840V.3	12	KE1022.5	13	KI60120.1	31	KPV50.3	88	KT80150.1	31
KA1850.3	13	KE1022.52	16	KI60120.3	31	KPV50.AL	88	KT80150.3	31
KA2530.3	13	KE1022.53	16	KI60120V.3	30	KPV75.1	88	KT80200.1	31
KA2530V.3	12	KE1030.3	13	KI60150.1	31	KPV75.2	88	KT80200.3	31
KA2540.3	13	KE120.1	31	KI60150.3	31	KPV75.3	88	KTC	21
KA2540V.3	12	KE120.3	31	KI60150V.3	30	KPV75.AL	88	KTC120	208
KA3030V.3	12	KE150.1	31	KI60200V.1	30	KPW1031.1	88	KTC120L	208
KA40100.1	31	KE150.3	31	KI60200V.3	30	KPW1031.3	88	KTCL	21
KA40100.3	31	KE1515.3	13	KI60250V.1	30	KPW1252.1	88	KTR100	31
KA40100V.3	30	KE1818.3	13	KI60250V.3	30	KPW1252.3	88	KTR12	65
KA40120V.3	30	KE1825.3	13	KI6060.1	31	KPW1252.5	88	KTR120	31
KA4040.3	13	KE1830.3	13	KI6060.3	31	KPW1252A	88	KTR150	31
KA4040V.3	12	KE1830.5	13	KI6060V.3	30	KPW1873.1	88	KTR200	31
KA4060.1	31	KE1830.52	16	KI6080.1	31	KPW1873.2	88	KTR250	31
KA4060.3	31	KE1830.53	16	KI6080.3	31	KPW1873.3	88	KTR30	31
KA4060V.3	30	KE1840.3	13	KI6080V.3	30	KPW1873.5	88	KTR40	31
KA4080.1	31	KE1850.3	13	KI80100V.3	30	KPW1873.AL	88	KTR60	31
KA4080.3	31	KE200.1	31	KI80120V.3	30	KPW1873A	88	KTR80	31
KA4080V.3	30	KE200.3	31	KI80150V.1	30	KRI50550.3	37	KV100.1	31
KA60100.1	31	KE2530.3	13	KI80150V.3	30	KRI50800.3	37	KV100.3	31
KA60100.3	31	KE2540.3	13	KI80200V.1	30	KRT40	36	KV1010.3	13
KA60100V.3	30	KE3030.3	13	KI80200V.3	30	KRT60	36	KV1015.3	25
KA60120.1	31	KE40100.3	31	KL103	64	KRT80	36	KV1015.CL	25
KA60120.3	31	KE4040.3	13	KP1031.1	88	KSTR60	46	KV1015.FG	25
KA60120V.3	30	KE4060.3	31	KP1031.3	88	KT1010.3	13	KV1022.3	13
KA60150.1	31	KE60.1	31	KP1031.5	88	KT1015.3	25	KV1022.5	13
KA60150.3	31	KE60.3	31	KP1252.1	88	KT1015.CL	25	KV1022.52	13
KA60150V.3	30	KE60250.1	31	KP1252.3	88	KT1015.FG	25	KV1022.53	13
KA60200V.1	30	KE60250.3	31	KP1252.5	88	KT1022.3	13	KV1030.3	13
KA60200V.3	30	KE80.1	31	KP1252A	88	KT1022.5	13	KV120.1	31
KA60250V.1	30	KE80.3	31	KP1873.1	88	KT1022.52	17	KV120.3	31
KA60250V.3	30	KE80100.3	31	KP1873.2	88	KT1022.53	17	KV150.1	31
KA6060.1	31	KE80120.3	31	KP1873.3	88	KT1030.3	13	KV150.3	31
KA6060.3	31	KI1010.3	12	KP1873.5	88	KT1515.3	13	KV1515.3	13
KA6060V.3	30	KI1015.3	25	KP1873A	88	KT1818.3	13	KV1818.3	13
KA6080.1	31	KI1015.CL	25	KP2504.1	92	KT1825.3	13	KV1825.3	13
KA6080.3	31	KI1015.FG	25	KP2504.2	92	KT1830.3	13	KV1830.3	13
KA6080V.3	30	KI1022.3	12	KP2504.3	92	KT1830.5	13	KV1830.5	13
KA80100V.3	30	KI1022.5	12	KP2504.AL	92	KT1830.52	17	KV1830.52	17
KA80120V.3	30	KI1022.52	16	KP2504.KR	92	KT1830.53	17	KV1830.53	17
KA80150V.1	30	KI1022.53	16	KP2504L.2	93	KT1840.3	13	KV1840.3	13
KA80150V.3	30	KI1030.3	12	KP2504L.3	93	KT1850.3	13	KV1850.3	13
KA80200V.1	30	KI1515.3	12	KP2504L.AL	93	KT2530.3	13	KV200.1	31
KA80200V.3	30	KI1818.3	12	KP503.1	93	KT2540.3	13	KV200.3	31
KAL	37	KI1825.3	12	KP503.2	93	KT3030.3	13	KV250.1	31
KC45	25	KI1830.3	12	KP503.3	93	KT40100R.1	31	KV250.3	31

Articolo Item	Pagina Page
STW70LV.3	65
STW70R.3	65
STW70RV.2	65
STW70RV.3	65

T

T10070.2	71
T10070.3	71
T10070.AL	71
T1611	242
T1614	242
T1615	242
T1628	242
T167	242
T2309	240
TA100V.2	64
TA100V.3	64
TA100V.AL	66
TA70V.2	64
TA70V.3	64
TA70V.AL	66
TE100.2	65
TE100.3	65
TE100.AL	67
TE5	395
TE70.2	65
TE70.3	65
TE70.AL	67
TE8	395
TI100V.2	64
TI100V.3	64
TI100V.AL	66
TI70V.2	64
TI70V.3	64
TI70V.AL	66
TK100.2	64
TK100.3	64
TK100.AL	66
TK100.CL	66
TK100.FR	66
TK100.WG	66
TK70.2	64
TK70.3	64
TK70.AL	66
TK70.CL	66
TK70.FR	66
TK70.WG	66
TP2309	240
TP309	240
TT100.2	65
TT100.3	65
TT70.2	65
TT70.3	65
TT70.AL	67
TV122-18	244
TV124-18	244
TV540	337
TV645	337
TV6-525	337
TV6-645	337
TV6-850	337
TV850	337
TW100.3	65
TW100.AL	67
TW100.CL	67
TW100.FR	67
TW100.WG	67
TW100V.2	65
TW100V.3	65
TW70.2	65

Articolo Item	Pagina Page
TW70.3	65
TW70.AL	67
TW70.CL	67
TW70.FR	67
TW70.WG	67
TW70V.2	65
TW70V.3	65

V

VOH4040	198
VOH4060	198
VOH60100	198
VOH6040	198
VOH6060	198
VOH6080	198
VOK4040	196
VOK4060	196
VOK60100	196
VOK6040	196
VOK6060	196
VOK6080	196
VOK80100	196
VOK80120	196
VOK8040	196
VOK8060	196
VOK8080	196
V100	197
V100B	197
V100H	198
V100W	197
V10R	204
V120	197
V120B	197
V120H	198
V120W	197
V20R	204
V25	197
V25B	197
V25H	198
V25HK	198
V25K	198
V25KB	197
V25KW	197
V25W	197
V30	197
V30R	204
V40	197
V40B	197
V40H	198
V40R	204
V40W	197
V4K100100	197
V4K100120	197
V4K10025	197
V4K10040	197
V4K10060	197
V4K10080	197
V4K2525	197
V4K2540	197
V4K4025	197
V4K4040	197
V4K4060	197
V4K4080	197
V4K60100	197
V4K60120	197
V4K6025	197
V4K6040	197
V4K6060	197
V4K6080	197
V4K80100	197

Articolo Item	Pagina Page
V4K80120	197
V4K8025	197
V4K8040	197
V4K8060	197
V4K8080	197
V5K100100	196
V5K10040	196
V5K10060	196
V5K10080	196
V5K4025	196
V5K4040	196
V5K4060	196
V5K4080	196
V5K60100	196
V5K6025	196
V5K6040	196
V5K6060	196
V5K6080	196
V5K80100	196
V5K80120	196
V5K8025	196
V5K8040	196
V5K8060	196
V5K8080	196
V60	197
V60B	197
V60H	198
V60W	197
V6B100100	196
V6B10060	196
V6B10080	196
V6B2525	196
V6B2540	196
V6B4025	196
V6B4040	196
V6B4060	196
V6B60100	196
V6B6025	196
V6B6040	196
V6B6060	196
V6B6080	196
V6B80100	196
V6B80120	196
V6B8025	196
V6B8040	196
V6B8060	196
V6B8080	196
V6H100100	198
V6H10040	198
V6H10060	198
V6H10080	198
V6H2525	198
V6H2540	198
V6H4025	198
V6H4040	198
V6H4060	198
V6H4080	198
V6H60100	198
V6H60120	198
V6H6025	198
V6H6040	198
V6H6060	198
V6H6080	198
V6H80100	198
V6H80120	198
V6H8025	198
V6H8040	198
V6H8060	198
V6H8080	198
V6HB100100	198
V6HB4040	198
V6HB8040	198

Articolo Item	Pagina Page
V6HB8060	198
V6HB8080	198
V6K100100	196
V6K100100W	196
V6K10030	196
V6K10030W	196
V6K10040	196
V6K10040W	196
V6K10060	196
V6K10060W	196
V6K10080	196
V6K10080W	196
V6K2525	196
V6K2525W	196
V6K2540	196
V6K2540W	196
V6K2580	196
V6K2580W	196
V6K4025	196
V6K4025W	196
V6K4030	196
V6K4040	196
V6K4040W	196
V6K4060	196
V6K4060W	196
V6K4080	196
V6K4080W	196
V6K60100	196
V6K60100W	196
V6K60120	196
V6K60120W	196
V6K6025	196
V6K6025W	196
V6K6030	196
V6K6040	196
V6K6040W	196
V6K6060	196
V6K6060W	196
V6K6080	196
V6K6080W	196
V6K80100	196
V6K80100W	196
V6K80120	196
V6K80120W	196
V6K8025	196
V6K8025W	196
V6K8030	196
V6K8040	196
V6K8040W	196
V6K8060	196
V6K8060W	196
V6K8080	196
V6K8080W	196
V7900	207
V80	197
V80B	197
V80H	198
V80W	197
V910	208
VC025	197
VC040	197
VC060	197
VC080	197
VC100	197
VC120	197
VRI40	207
VRI60	207
VRV40	207
VRV60	207
VS10	204
VS12	204
VS16	204

Articolo Item	Pagina Page
VS20	204
VS25	204
VS6	204
VS8	204
VTC125B	209
VTC125L	209
VTC125PL	209
VTG-2	209
VTG-5	209
VTK6	199

Z

ZCU1	223
ZCU2	223
ZCV1	223
ZCV2	223
ZPC2	220
ZPC3	220
ZPC5	220
ZPE2	220
ZPE3	220
ZPE5	220
ZPR2	222
ZPR3	222
ZPR5	222
ZPW2	220
ZPW3	220
ZPW5	220
ZTC2	221
ZTC3	221
ZTC5	221
ZTE2	221
ZTE3	221
ZTE5	221
ZTR2	222
ZTR3	222
ZTR5	222
ZTW2	221
ZTW3	221
ZTW5	221

1

10489.2	68
10489.3	68
10489.AL	68
10489.CL	68
10489.FR	68
10489.QC	68
10489.WG	68
10689.2	68
10689.3	68
10689.AL	68
10689.CL	68
10689.FR	68
10689.QC	68
10689.WG	68
10889.2	70
10889.3	70
10889.AL	70
124M1201B	318
124M12EX03	319
124M1601B	318
124M1601C	324
124M1603C	324
124M16DT	325
124M16EX03	319
124M2001B	318
124M2001C	324



Via G. Di Vittorio, 34/36
50067 - Rignano sull'Arno (Fi)
Telefono +39 055 8349181
Telefax +39 055 8349185
Sito: www.arnocanali.it
E-mail: info@arnocanali.it



arnocanali
per portare energia

Via G. Di Vittorio, 34/36
50067 - Rignano sull'Arno (Fi)
Telefono +39 055 8349181
Telefax +39 055 8349185
Sito: www.arnocanali.it
E-mail: info@arnocanali.it